



SINCE 1977

YIH TROUN

Patent Product

INDEXABLE TOOL

2025. 03

INDEXABLE UFO FAMILY ●

INDEXABLE SAW ●

INDEXABLE SIDE /DISC MILLING CUTTER ●

INDEXABLE CENTER DRILL / SPOT DRILL ●

INDEXABLE COUNTERBORE ●

INDEXABLE CHAMFER KING ●

INDEXABLE UFO MILL ●



SINCE 1977



COMPANY INTRODUCTION



Profile

Yih Troun set the first milestone in 1977 as a professional manufacturer of carbide Milling, Drilling, Turning cutters in Taiwan. Since Yih Troun's inception, over 43 years, we have always geared towards research and development of innovative insert type cutting tools, such as our trade mark products, Indexable Slitting Saw, UFO Mill, UFO Thread Mill and UFO T-Slot. Face the changing variety of workpiece materials and the ever-increasing production cost, we always bear in mind the motto of Mr. David Chen, our founder and President – “Increasing Production Efficiency”; that has motivated the company keeps on the leading edge of cutting tools industry. We believe the indexable carbide cutter provides the most effective solution of great tool life and impressive machining efficiency, meanwhile it precipitates machining cost saving.

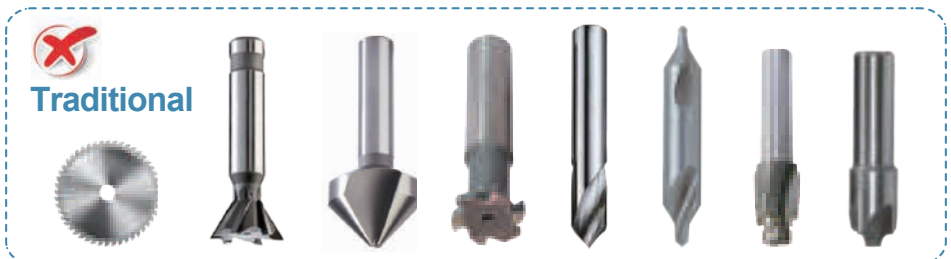

Milestone

- 1977** Yih Troun was established as a manufacturer of milling and turning holders.
- 1990** Started to import and distribute SECO(Sweden), Fraisa(Switzerland) and some other well-known global brands.
- 1996** Started to export our own products, e.g.: Carbide cutting tools, End Mills, we also represented other domestic outstanding brands products for export.
- 2000** Innovated the first ever “High Feed Cutter”, it obtained the patents of several countries and receive excellent reputation in worldwide relative business field in the world.
- 2005** Set up the insert production department, innovated a wide variety of indexable carbide inserts. The overall insert specification up to 1000 items.
- 2006** Took the lead in creating the “Locking Saw Blade”, and gained the technological cooperation with National Taiwan University of Science and Technology.
- 2007** Won the “Top 100 Taiwan Enterprise Award”.
- 2008** Yih Troun became the guided Factory of Ministry of Economic Affairs, R.O.C. obtained the right of priority over world patents from the United Nations.
- 2009** Yih Troun's “Locking Saw Blade”, received patent approval.
- 2010** Established the world's most complete locking type saw blade and T-slot milling cutter. Yih Troun's indexable saw won the Ringier Technology Innovation Award 2010.
- 2012** Announced the patented “Indexable Countersink”, comprehensive range from $\phi 4.0$ ~ $\phi 110$ mm, it's approved by Taiwan, China and the UN patents.
- 2013** Announced the smallest indexable thread mill and taps, designed with 2 flutes from min $\phi 8.0$ mm. Patent applications in progress.
- 2014** Special invitation in “Emerging Industry Incubation-Accelerating Program”, received “Top 1,000 Taiwan D&B SME Award” and “Ringier Technology Innovation Awards”.
- 2016** Innovation Awards”.
- 2017** Set up German company "Yih Troun Cutting Tools GmbH".
- 2019** Announced UFO Mill officially with global patent.
- 2024** Set up Japan company "UFO Co., Ltd."



Global Patent Certifications

- 2000 Indexable High Feed Cutter - Global Patent
- 2007 Taiwan Top 100 Enterprise Award
- 2009 Taiwan Government Special Advisory for Factories
- 2009 Indexable Saw Blade - Global Patent
- 2010 Ringier Metal Industry Innovation Award
- 2012 Indexable Countersink - Global Patent
- 2013 Honorary member of Taiwan Machinery Association

- 2014 Ringier Technology Innovation Awards, Indexable Tap - Global Patent
- 2015 ~ 2016 Top 1000 D&B SME Award
- 2019-2023 Konisches, polygonales Design Patentgenehmigung erhalten.
(Taiwan, European Union, United States, Canada, Russia, China, Japan, South Korea)



Customer Base

High technology, quality & performance guarantee.

Having established strong base in Taiwan, Y.T. involves operations in Aerospace, Automotive, Electrical & Electronic, Medical industries, as well as General machining and Machine building industries. During the years, we had announced and been successful in obtaining more than 40 patents granted in a number of different countries.

COUNTRIES ISSUING FOR PATENT CERTIFICATION



New
System
For Hole
Making

390

Insert Center Positioning Patent Design

Optimal Center Positioning Design

The patented insert tapered profile was designed to minimize the tolerance $\pm 0.008\text{mm}$ and optimizes the center positioning, it reaches the great accuracy and bear the best economic efficiency.

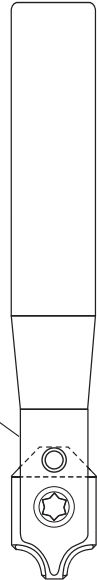
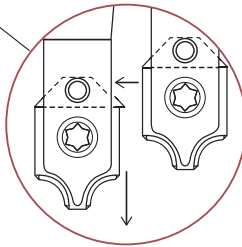
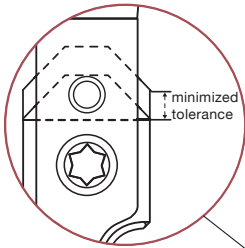
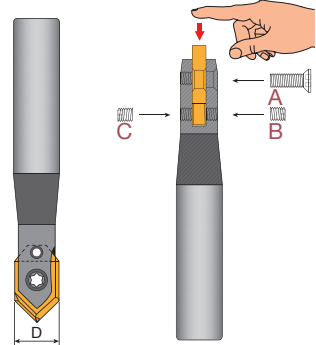

390 Clamping system

Hold the insert at front and back sides to ensure the clamping strength.

The insert is clamped exactly in the middle of the shank to achieve the best centering accuracy, especially in high speed machining.



Applications

390 clamping system is applicable to below applications:

1. Center drill
2. Spot drill
3. Corner Rounding
4. 4 in 1 counterbore
5. Engraving



Spot Drill



Center Drill



Corner Rounding





4 in 1 Counterbore



Engraving tool

Patent No.
 M473882
 M474588
 M473881

Patent No.
 201310453057.2
 201320772697.5

PCT Priority No.
 PCT/ CN2013/086393



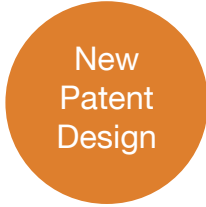

New
Patent
Design

UFO

Family

Optimal Tapered Polygon Design

This unique UFO insert is designed with a tapered polygon profile to optimize the stability and precision. It's an optimal center positioning with varieties of different UFO inserts, easy to change the insert and keep the tolerance minmization.

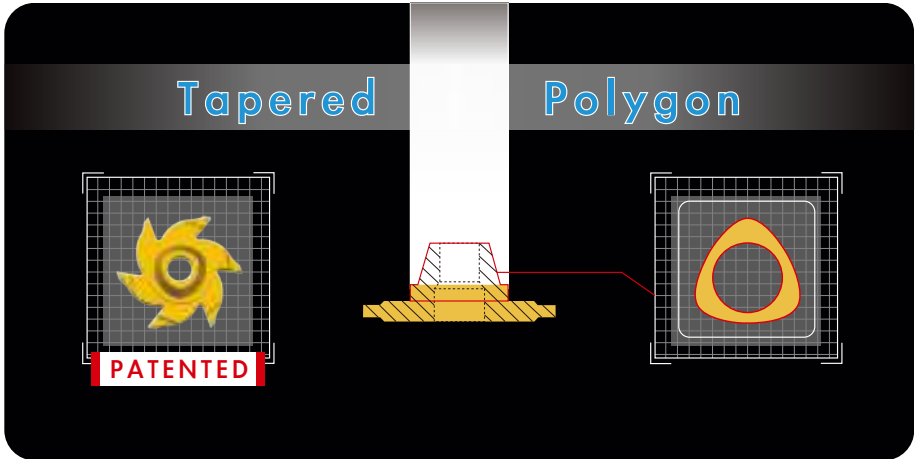



Applications

9 different kinds of application are available with UFO family:
 T-slot, thread milling, radius, dovetail, chamfer, circlip,
 counterbore, dual corner rounding and concave.

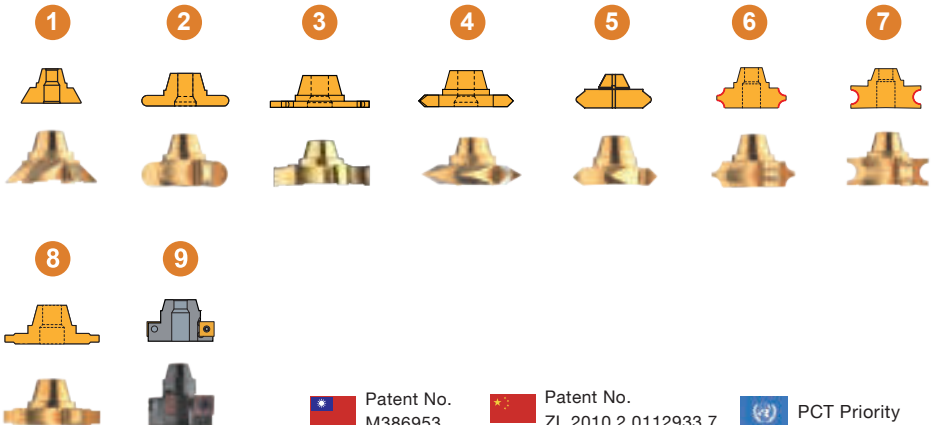













 Patent No.
M386953





 Patent No.
ZL 2010 2 0112933.7





 PCT Priority



Code	Category	Product Image	Size Rang	Page
CB3 CB3W	HSS Shank Carbide Shank		Dia. 6~32 mm Length 50~200 mm	24 29
3T	UFO T-SLOT Insert		Dia. 10-37 mm AE 0.5~8.0 mm	34 75
	UFO T-SLOT Cutter		Dia. 32/ 35/ 40/ 50/ 60/ 80 mm AE 1.4 / 1.5/ 1.6/ 1.8/ 2.0/ 2.2/ 2.5/ 2.7/ 3.0/ 3.2/ 3.5/ 4.0/ 4.2/ 4.5/ 5.0/ 5.2/ 5.5/6.0/ 8.0 mm	77 82
				
	UFO T-SLOT Cutter (Fit round insert)		Dia. 60/ 80 mm 4R/ 5R/ 6R	86
	UFO Radius Insert		Dia. 20 mm Radius 0.5/ 0.75/ 1.0/ 1.25/ 1.5/ 2.0/ 2.5/ 3.0	89
	UFO Dual Corner Rounding Insert		Dia. 9.8/ 11.8/ 19.8 mm Radius 0.5/ 0.75/ 1.0/ 1.25/ 1.5/ 2.0	90
	UFO Dual Chamfer Insert		Dia. 9.8/ 11.8/ 14.8 mm Chamfer Angle 45°	91
	UFO Dovetail Insert		Dia. 20 mm Angle 45° /60°	
	UFO Concave Radius Insert		Dia. 20 mm Radius 1.0/ 1.25/ 1.5/ 2.0	92
C3T	UFO Circlip Insert		Dia. 20 mm A: 1.21/ 1.41/ 1.71/ 1.96/ 2.26/ 2.76/ 3.26/ 4.26 mm	93
AT BT/BTL UT/UTL	Solid Carbide Thread Milling Cutter		Dia. 1.95~10mm Pitch 0.35~2.5mm TPI 72~10	99 101





3T1	UFO Thread Milling Insert (Partial Profile)		Dia. 12/ 15/ 20/ 25 mm Pitch 1.0~5.0 mm /16-5 TPI		102 105
3T	UFO Thread Milling Insert (Full Profile)		Pitch 1.0/ 1.25/ 1.5/ 2.0/ 2.5/ 3.0/ 3.5mm UNC 16~8 TPI BSW 16~8 TPI		106 115
B3T	UFO Back Boring Cutter		Entrance 10.4/ 12.4 16.4/ 25.4	Back Bore 18-22/ 23-30 31-40/ 41-60	131 133

Code	Category	Product Image	Size Rang	Page
BB3 BB3W	Common Holders		Dia. 9.7/ 11.5/ 13.5/ 15.5/ 17.5/ 19.5/ 24.5mm Length 60~180mm	149 152
3B	Milling Heads M/ME/E		Dia. 10/ 11/ 12/ 13/ 14/ 15/ 16/ 17/ 18/ 20/ 21/ 25mm AE 5-12.5mm	154 168
3BH	High Feed Milling Heads		Dia. 10/ 11/ 12/ 13/ 16/ 17/ 20/ 21/ 25mm	173
3BC	High Feed Chamfer Milling Heads		Dia. 10/ 13/ 16 Angle 30°/45°/60°	175



Code	Category	Product Image	Size Rang	Page
SB	Saw Blade		Dia. 50/ 63/ 80/ 100/ 125/ 160/ 200/ 250/ 285/ 300 mm AE 1.4/ 1.5/ 1.6/ 1.8/ 2.0/ 2.2/ 2.5/ 2.7/ 3.0/ 3.2/ 3.5/ 4.0/ 4.2/ 4.5/ 5.0/ 5.2/ 5.5 mm	188 199
SBL	Saw Milling Cutter		Dia. 80/ 100/ 125/ 160 mm AE 1.4/ 1.5/ 1.6/ 1.8/ 2.0/ 2.2/ 2.5/ 2.7/ 3.0/ 3.2/ 3.5/ 4.0/ 4.2/ 4.5/ 5.0/ 5.2/ 5.5 mm	202 204
STL	Side Milling Cutter		Dia. 80/ 100/ 125/ 160 mm AE 4/ 5 mm	205
BL BLL	Adapter Holder		Dia. 45/ 58 mm I.D. 22/ 25.4/ 31.75/ 32 mm	206
SCL	Side Milling Cutter		Dia. 160/ 200/ 250 mm AE 6/ 8/ 10/ 12 mm	209

Code	Category	Product Image	Size Rang	Page
CEL	Disc Milling Cutter		Dia. 160/ 200/ 250 mm AE 14/ 16/ 18/ 20/ 22/ 25/ 30 mm	210 211
CWL	Back Milling Cutter		Dia. 160/ 200/ 250 mm AE 12 mm	212
BCL	Adapter Holder		Dia. 65/ 90 mm I.D. 32/ 31.75/ 40/ 38.1/ 60/ 50.8 mm	212 213
SC	Side Milling Cutter		Dia. 80/ 100/ 125/ 160 mm AE 4/ 5/ 6/ 7/ 8/ 10/ 12 mm	215 220
ST			Dia. 80/ 100/ 125/ 160 mm AE 6/ 7/ 8/ 10/ 12 mm	221 222
CE	Disc Milling Cutter		Dia. 80/ 100/ 125 mm AE 14/ 16/ 18/ 20/ 22/ 25/ 30 mm	224 226
CW			Dia 80/ 100/ 125 mm AE 14/ 16/ 18/ 20/ 22/ 25/ 30 mm	227 229
CB	Back Milling Cutter		Dia. 100/ 125 mm AE 12 mm	232
CDL CDR	Straddle Milling Cutter		Dia. 100/ 125/ 160 mm AE 12 mm	233

Code	Category	Product Image	Size Rang	Page
13	Spot Drill		Dia. 8/ 10/ 12/ 16 mm Angle 90° / 90° +142° / 142°	257
GA	Centralizer		I.D. 8.2/ 10.2/ 12.2/ 16.2 mm	269
TU1 TU	Center Drill		Pilot Dia. 1.6/ 2.0/ 2.5/ 3.0/ 4.0/ 5.0/ 6.0/ 8.0mm Angle 1) A type 60° 3) D type 60° 2) C type 90°	270
				
	Engraving Tool		E type 60° Tip Width 0.15 mm	274

Code	Category	Product Image	Size Rang	Page
14	4 IN 1 Counter Bore		Dia. M3/ M3.5/ M4/ M5/ M5.5/ M6/ M6.5/ M7/ M7.5/ M8/ M9/ M10/ M11/ M12/ M14	285
CBK	Counter Bore for Traditional Machine		Dia. 14/ 15/ 18/ 20/ 22/ 24/ 25/ 26/ 27 mm	294
HBM	Counter Bore for Traditional Machine		Dia. 26/ 29/ 33/ 36/ 40/ 50/ 58 mm	295
CBI	Counter Bore for CNC Machine		Dia. 15/ 18/ 20/ 24/ 26/ 29/ 33/ 36/ 40/ 50/ 58 mm Chamfer Angle 45°	296

Code	Category	Product Image	Size Rang	Page
CI	Countersink		Dia. 4~39 mm Countersink Angle 60°/90°/100°/120°	304
HCI			Dia. 4~39 mm Countersink Angle 60°/90°/120°	305
			Dia. 20~110 mm Countersink Angle 90°	306
C	Chamfer Cutter for CNC Machine		Dia. 10~70 mm Angle 30°/45°	312
MC HMC			Dia. 11~45 mm Angle 45°	314
15	Corner Rounding Cutter		Dia. 16/ 25 mm Radius R1~R10	318

Code	Category	Product Image	Size Rang	Page
XD	Dovetail Milling Cutter		Dia. 40/ 60/ 80 mm Angle 50° / 55° / 60°	323
XV			Dia. 120 mm Angle 45°/50°/55°/60°	324
MO	Face Milling Cutter for Alluminium		Dia. 80/ 100/ 125/ 160/ 200/ 250/ 300 mm AP 3 mm	331

TECHNICAL GUIDE

Code Keys

Insert-Metric series, extract from the international standard. Listed dimensions are the theory measurement for reference. The normal size and tolerance of type codes indicated, on the following list are exactly different. To check the exact tolerance of each insert, please refer to the relative page of inserts.





1. Shape

2. Side Clearance Angle

0 = Special

Code Keys

3.Tolerances													
Tol.- Class	Tolerance +/-mm			For d, dimension(mm)									
	 m	 AE	 d	3.175*	4.76	6.35	9.525	12.7	15.875	19.05	25.4	31.75	38.1
A	0.005	0.025	0.025	•	•	•	•	•	•	•	•	•	•
E	0.025	0.025	0.025	•	•	•	•	•	•	•	•	•	•
F	0.005	0.025	0.013	•	•	•	•	•	•	•	•	•	•
G	0.025	0.13	0.025	•	•	•	•	•	•	•	•	•	•
H	0.013	0.025	0.013	•	•	•	•	•	•	•	•	•	•
J	0.005	0.025	0.05	•	•	•	•						
	0.005	0.025	0.08					•					
	0.005	0.025	0.10						•	•			
	0.005	0.025	0.13								•		
	0.005	0.025	0.15									•	•
K	0.013	0.025	0.05	•	•	•	•						
	0.013	0.025	0.08					•					
	0.013	0.025	0.10						•	•			
	0.013	0.025	0.13								•		
	0.013	0.025	0.15									•	•
M	0.08	0.13	0.05	•	•	•	•						
	0.13	0.13	0.08					•					
	0.15	0.13	0.10						•	•			
	0.18	0.13	0.13								•		
	0.20	0.13	0.15									•	•
U	0.13	0.13	0.08	•	•	•	•						
	0.20	0.13	0.13					•					
	0.27	0.13	0.18						•	•			
	0.38	0.13	0.25								•	•	•



Inserts Code Keys

4. Type

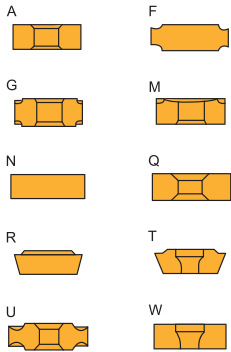

X=Special

5. Cutting edge length

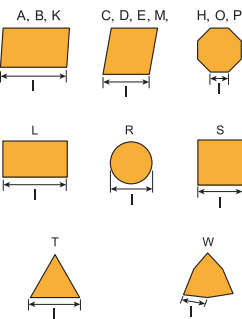

6. Thickness

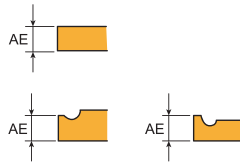

01=1,59 mm	04=4,76 mm
T1=1,98 mm	05=5,56 mm
02=2,38 mm	06=6,35 mm
03=3,18 mm	07=7,94 mm
T3=3,97 mm	08=8,00 mm
	09=9,52 mm

8. Cutting edge designation

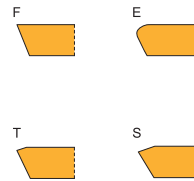

Not mandatory information

7. Insert with corner chamfers / nose radius



1nd letter

A=45°
D=60°
E=75°
F=85°
P=90°

Z=Special



2nd letter

A=3° F=25°
B=5° G=30°
C=7° N=0°
D=15° P=11°
E=20°

Z=Special



nose radius

M0*= round inserts
00= sharp
01= 0,1mm
02= 0,2mm
04= 0,4mm
08= 0,8mm
12= 1,2mm
etc
*Metric version

9. Direction of cutting

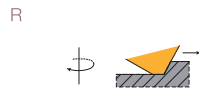

Right-rotated

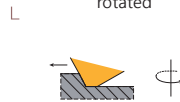

Left-rotated

N
Neutral
(R- and L-rotated)

10. Internal designation

Machining conditions
E = Easy
M = Medium
D = Difficult

11. For TAP only

Tolerance : 6H · 8H

Insert Grades

Grades

Cemented carbide is an alloy of tungsten carbide (WC) and cobalt (Co). Cubic carbides like tantalum carbide (TaC), titanium carbide (TiC) and niobium carbide (NbC) can also be added. Tungsten carbide is the main component and gives the hardness. Cobalt is the binder phase and gives the toughness. Cubic carbides are added in order to affect properties like hot hardness, deformation resistance and chemical wear resistance.

Most modern grades are coated with either CVD (Chemical Vapour Deposition) or PVD (physical Vapour Deposition) technique.

The coating improves the wear resistance of the grade.







With CVD-technique layers of titanium carbide (TiC), titanium nitride (TiN), titanium carbonitride (Ti(C,N)) and alumina (Al₂O₃) can be made. CVD-coated grades are suitable for wear resistance in demanding applications with high feed rates and intermediate to high cutting speed.

The common coating materials made by PVD-technique are titanium nitride (TiN), titanium carbonitride (Ti(C,N)) and titanium aluminium nitride ((Ti,Al)N). PVD-coated grades are recommended for applications with low feed rate where high edge toughness is required. PVD-coated grades are suitable for applications with low to intermediate cutting speed.

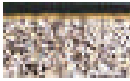
	Grades	P Steel					M Stainless Steel				K Cast iron				N Non Ferrous Metal				S Heat resistant super alloys				H Hardened steel						
		P01	P10	P20	P30	P40	P50	M01	M10	M20	M30	M40	K01	K10	K20	K30	K40	N01	N10	N20	N30	S01	S10	S20	S30	H01	H10	H20	H30
PVD	K10																												
	B100																												
	B350																												
	C250																												
	C350																												
	F20																												
	F30																												
	CE100																												

Insert Grades

PVD coated grades

	B100	B100 is a unique rare metal grade with great heat and cracking resistance. Tialn
	B350	B350 has enhanced the toughness of the tungsten carbide to increase the durability. Specially used in the application of 390 design such as spot drill, center drill, 4-1 counterbore. Tialn
	C250	C250 has a tough substrate in steel machining. Helica
	C350	C350 is the best recommend grade for steel machining. Especially in 390 system. (Spot Drill, 4-1 Counterbore, Corner Rounding) Helica
	F20	This substrate is in accordance to the ISO K, N classification. For application in Cast iron and non-ferrous metal such as Aluminum, copper or plastic ... etc. Tin
	F30	F30 is the substrate with new and heat-resistance coating suitable for cast iron. Helica
	CE100	CE100 is an innovative cermet substrate with great heat and abrasion resistance to improve durability in stable machining conditions. Tialn

Uncoated grades

	K10	Hard, wear resistant grade for milling in Aluminum and Non-ferrous metal.
---	-----	---

Insert Geometries

Designation system

The Y.T. designation system for milling inserts has been developed to provide users with better guidance concerning the fields of application for various insert geometries.



Difficult machining conditions, strong insert cutting edge.



Easy machining conditions, sharp insert cutting edge.

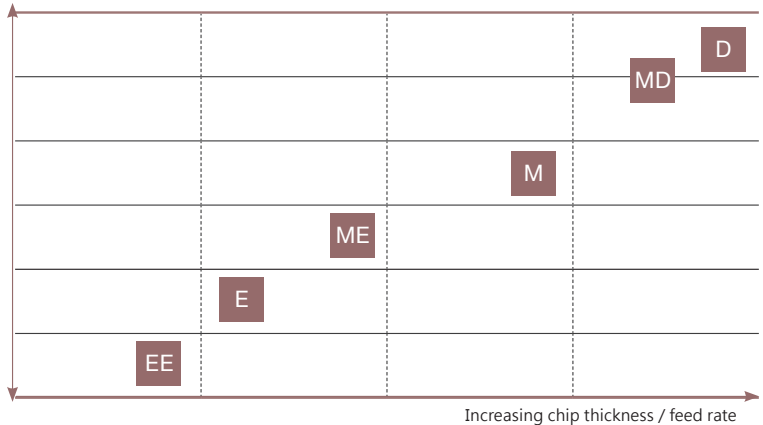

Examples of different insert geometries for a specific insert type.



..AFTN-D Negative and very protected cutting edge



..AFTN-MD Negative and protected cutting edge



..AFTN-M Positive and protected cutting edge



..AFTN-ME Very positive and protected cutting edge



..AFN-E Very positive and very sharp cutting edge



..AFN-EE Very positive and very extremely cutting edge



UFO FAMILY SERIES

One Shank for Max.
Over 400 types insert

“UFO” design is the Y.T.'s innovative-patented insert positioning with tapered polygonal design to achieve higher centering accuracy. It is named after UFO space ship because of its insert design. The holders of the entire series can fit in different types of inserts: T-slot, Thread Milling, Radius, Dual Corner Rounding, Concave Radius, Dual Chamfer, Dovetail, Circlip, Back Boring, Gear Machining. The holders are available in different diameters and lengths. Totally 6 shanks fit more than 1400 inserts.



Video



Patent No.
M530197



Patent No.
ZL 201620538204.5



PCT Priority





PATENTED

One holder fits differen inserts up to 400 types

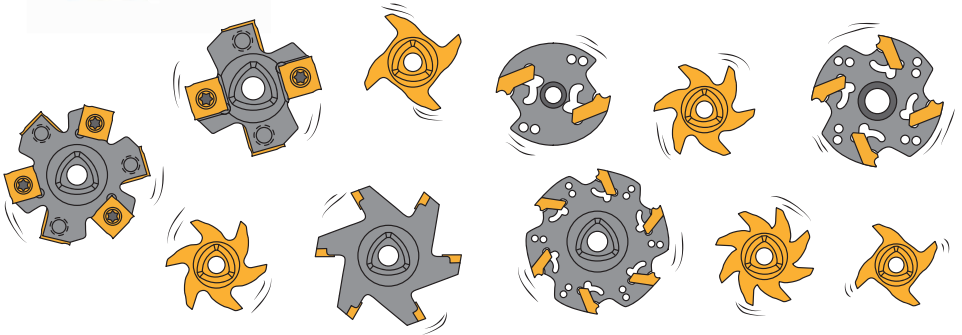

Design Of UFO Family

Shank

1. High precision HSS shank (HRC60) with good stability and excellent strength.
2. Comprehensive toolholders with 4 different types of shank, available with overhangs from 40~240mm.
3. The same shank can fit more than 400 different inserts

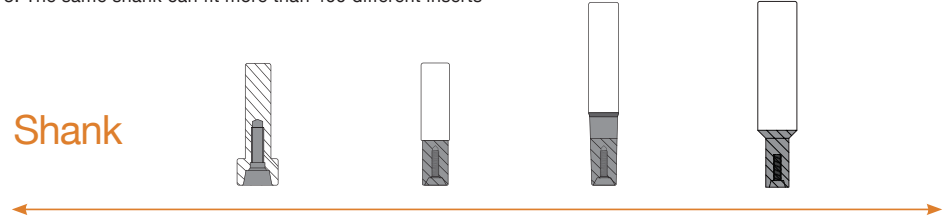

Insert

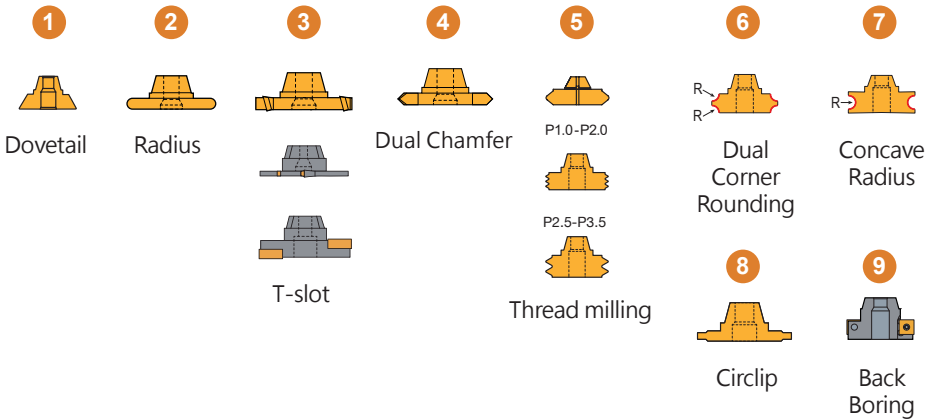

Tapered Polygon (Grinded)

Capacity

Polygon positioning design has a greater torque capacity than any other positioning designs, the load is generated over a generous area which assure the strength of the shaft.

Multi Application

Tapered polygon design offers a simple connection with different inserts and applications.

Center Positioning

The interface is tapered design for keeping eccentricity $\leq 0.01\text{mm}$, which enhance the cutting speed and insert tool life.



PRODUCT SPECIFICATIONS

UFO Family Common Toolholders

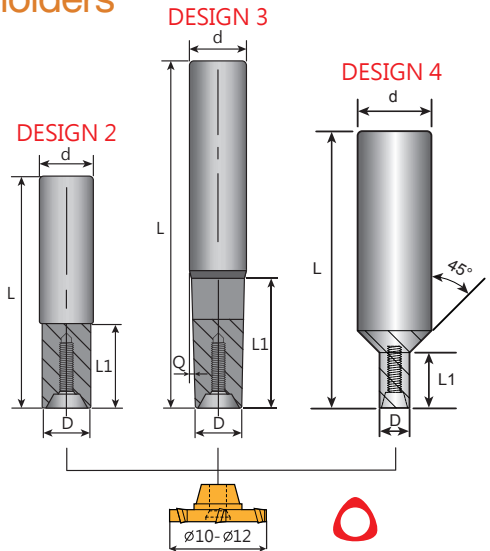
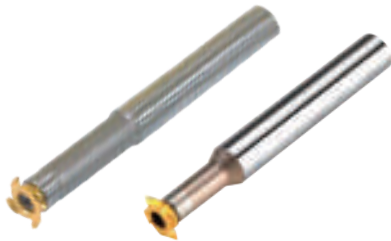

CB3

• HSS Shanks

Order code	Dimensions (mm)					Design	KG	Inserts	Screw	Key
	D	d	L	L1	Q					
CB3-0606-55-12	6.5	6	55	10	-	2	Ø10 Ø11 Ø12	C03012	T09P	
CB3-0808-80-12	7.9	8	80							
CB3-1006-100-12	6.5	10	100	20	1°	3				
CB3-1008-100-12	7.9			30						
CB3-1606-60-12	6.5	16	60	12	-	4				
CB3-1608-65-12	7.9		65	16						

CB3W

• Carbide Shanks

Order code	Dimensions (mm)					Design	KG	Inserts	Screw	Key
	D	d	L	L1	Q					
CB3W-0808-80-12	7.9	8	80	10	-	2	0.11	Ø10 Ø11 Ø12	C03012	T09P
CB3W-1008-100-12	7.9	10	100	30	1°	3	0.16			

• To check the max. AR, please refer to the page of relative inserts or cutters.

UFO Family Common Toolholders

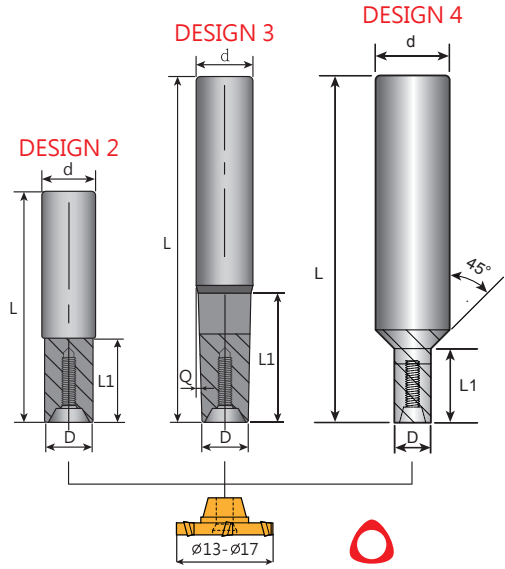
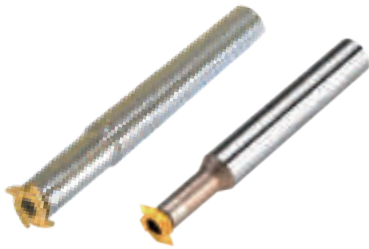

CB3 • HSS Shanks

Order code	Dimensions (mm)					Design	KG	Inserts	Screw	Key
	D	d	L	L1	Q					
CB3-0808-55-15	7.9	8	55	10	-	2	0.08	Ø13 Ø14 Ø15 Ø16 Ø17	C03012	T09P
CB3-1010-90-15	9.9	10	90							
CB3-1208-110-15	7.9	12	110	30	1°	3	0.14			
CB3-1210-120-15	9.9		120							
CB3-1608-75-15	7.9	16	75	16	-	4	0.24			
CB3-1610-80-15	9.9		80							

CB3W • Carbide Shanks

Order code	Dimensions (mm)					Design	KG	Inserts	Screw	Key
	D	d	L	L1	Q					
CB3W-1010-90-15	9.9	10	90	10	-	2	0.15	Ø13 Ø14 Ø15 Ø16 Ø17	C03012	T09P
CB3W-1208-110-15	7.9	12	110	30	1°	3	0.21			
CB3W-1210-120-15	9.9		120							

• To check the max. AR, please refer to the page of relative inserts or cutters.



UFO Family Common Toolholders

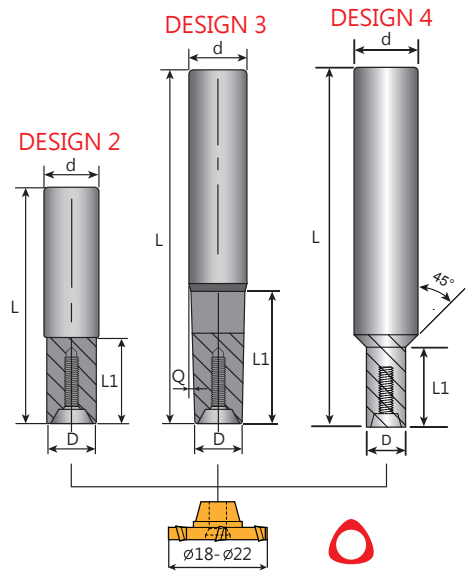

CB3

• HSS Shanks

Order code	Dimensions (mm)					Design	Ⓚ KG	Inserts	Screw	Key
	D	d	L	L1	Q					
CB3-1010-80-20	9.8	10	80	12	-	2	ø18 ø19 ø20 ø21 ø22	C03513	T10P	
CB3-1010-100-20			100							
CB3-1210-90-20		12	90	25	3.2°	3				
CB3-1210-130-20			130	40	1.7°					
CB3-1610-90-20	11.8	16	90	20	-	4	C03513	T10P		
CB3-1612-95-20			95	25	-	4				
CB3-1612-150-20		150	150	55	2.4°	3				
CB3-1616-150-20				15.8	20	-			2	

CB3W

• Carbide Shanks

Order code	Dimensions (mm)					Design	Ⓚ KG	Inserts	Screw	Key
	D	d	L	L1	Q					
CB3W-1010-100-20	9.8	10	100	12	-	2	0.18	ø18 ø19 ø20 ø21 ø22	C03513	T10P
CB3W-1212-150-20	11.8	12	150	20	-	2	0.32			

• To check the max. AR, please refer to the page of relative inserts or cutters.

UFO Family Common Toolholders

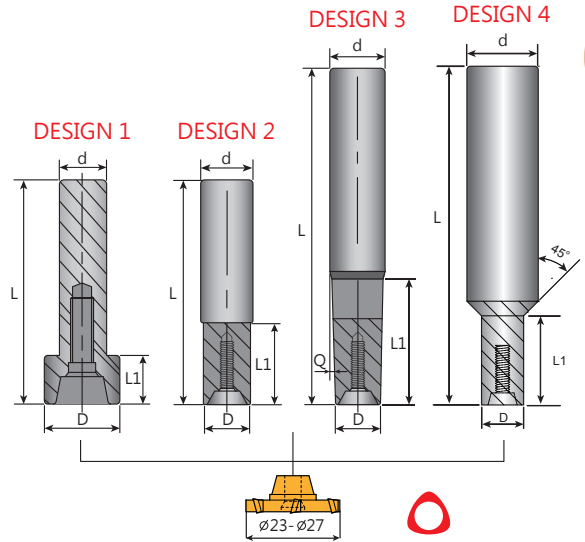

CB3

• HSS Shanks

Order code	Dimensions (mm)					Design	KG	Inserts	Screw	Key
	D	d	L	L1	Q					
CB3-1012-50-25	11.8	10	50	10	-	1	0.11	ø 23 ø 24 ø 25 ø 26 ø 27	C04017	T15P
CB3-1212-90-25		12	90	12	-	2	0.16			
CB3-1212-110-25		16	110	35	4.2°		0.18			
CB3-1612-110-25			150	55	2.4°	0.24				
CB3-1612-150-25		20	95	25	-	4	0.50			
CB3-2012-95-25				30	-		0.55			
CB3-2016-95-25				15.8	150	20	-			
CB3-2020-150-25	19.8									

CB3W

• Carbide Shanks

Order code	Dimensions (mm)					Design	KG	Inserts	Screw	Key
	D	d	L	L1	Q					
CB3W-1212-110-25	11.8	12	110	12	-	2	0.26	ø23 ø24 ø25 ø26 ø27	C04017	T15P
CB3W-1616-150-25	15.8	16	150	20			0.54			

• To check the max. AR, please refer to the page of relative inserts or cutters.



UFO Family Common Toolholders

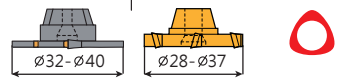
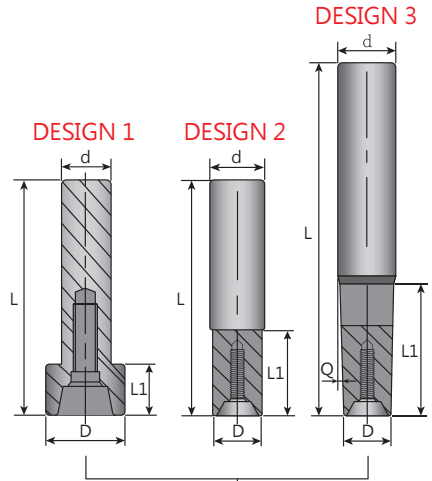

CB3 • HSS Shanks

Order code	Dimensions (mm)					Design	KG	Inserts	Screw	Key	
	D	d	L	L1	Q						
CB3-1016-50-30	15.8	10	50	10	-	1	0.13	ø 28 ø 29 ø 30 ø 32 ø 35 ø 37 ø 40	C05016	T20P	
CB3-1616-120-30		16	120	15		2	0.28				
CB3-1616-150-30		150	15	45	3.8°	3	0.34				
CB3-2016-150-30							0.45				
CB3-2016-180-30		19.8	20	180	70	2.0°	2				0.51
CB3-2020-90-30				90	20	-	2				0.54
CB3-2020-150-30	150			0.56							
CB3-2020-180-30	180	0.58									

CB3W • Carbide Shanks

Order code	Dimensions (mm)					Design	KG	Inserts	Screw	Key
	D	d	L	L1	Q					
CB3W-1616-150-30	15.8	16	150	15	-	2	0.55	ø 28 ø 29 ø 30 ø 32 ø 35 ø 37 ø 40	C05016	T20P
CB3W-2016-180-30		20	180	70	2.0°	3	0.87			

• To check the max. AR, please refer to the page of relative inserts or cutters.

UFO Family Common Toolholders

- Combi Toolholders P. 336 - 337

UFO Family

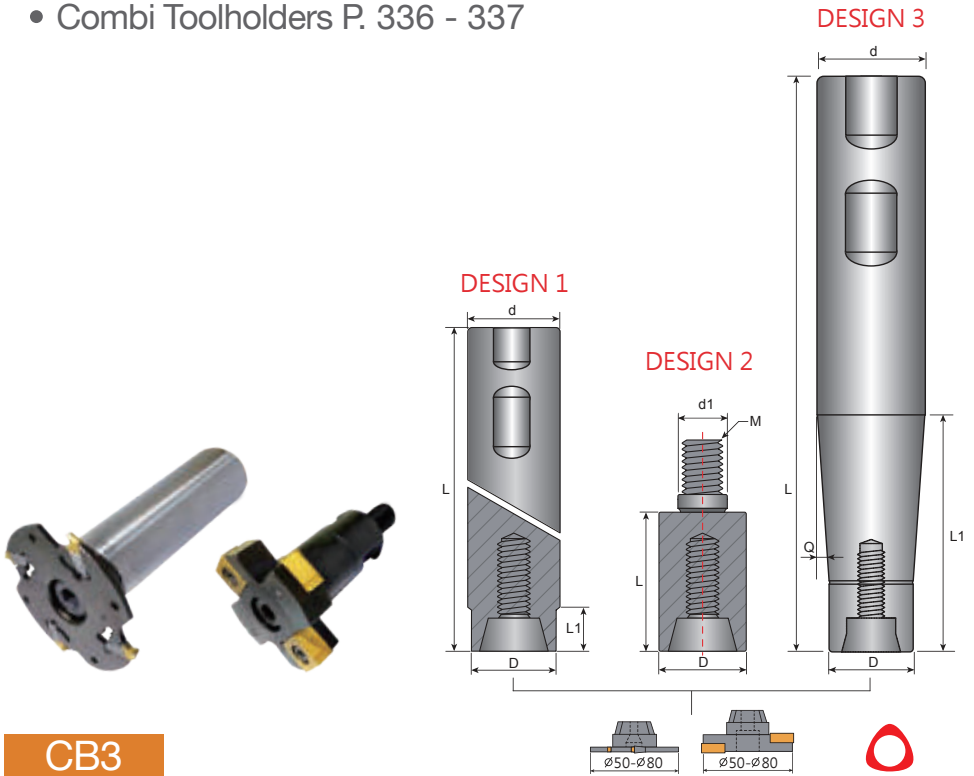

CB3

Order code	Dimensions (mm)							Design	KG	Inserts	Screw	Key
	D	d	d1	L	L1	M	Q					
CB3-2525-110	24.8	25	-	110	15	-	-	1	0.42	ø 50 ø 80	M0825	-
CB3-2525-170				170								
CB3-25A	25.0	-	12.5	40	-	12	-	2	0.17	ø 50 ø 80	M0825	-
CB3-25			14									
CB3-3225-110	24.8	32	-	110	40	-	10°	3	0.62	ø 50 ø 80	M0825	-
CB3-3225-170				170			70					

- To check the max. AR, please refer to the page of relative inserts or cutters.



UFO T-SLOT CUTTER



Video

Features

Available in materials



Cost
200~300%
SAVING

Applicable
Machines
CNC Milling machine

Efficiency
400%
UP

Durability
300%
UP

Insert Design

1. Minimum thickness starts from 0.5mm, and the insert thickness under 2mm is available in slight variation with every 0.1mm difference.
2. 9 different types of inserts are available for selection, the minimum diameter is 10mm.
3. The front-mounted insert is positioned into a tapered seat for center-positioning, giving secure and continuous performance.
4. High productivity with more teeth.(4-8 teeth)

Product Introduction

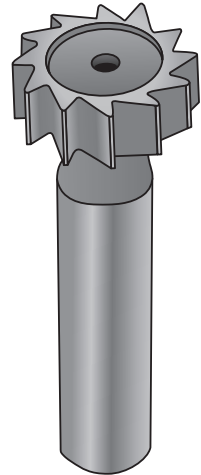
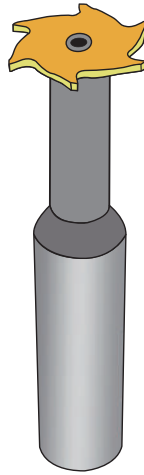
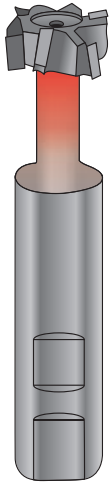

Carbide brazed

1. Welding carbides on the cutter under high temperature will degrade the tool-holder hardness.
2. Insufficient hardness.
3. Only available in thickness over 2mm.

Toolholders grade: HSS Hardness up to HRC 58

1. One tool-holder can fit in 400 different types of inserts.
2. Insert has patented geometry design.
3. Most suitable for high speed cutting.

Toolholders grade: HSS

1. Insufficient hardness.
2. Hard to regrind.
3. Not suitable for high speed cutting.



UFO T-SLOT[®]

FULL RANGE

PATENTED



• P. 34-75



Thickness:

0.5/0.6/0.7/0.8/0.9/1.0/1.1/1.2/1.3/
1.4/1.5/1.6/1.7/1.8/1.9/2.0/2.2/2.5/
3.0/3.5/4.0/4.2/4.5/5.0/6.0/8.0 mm

Dia. 10/11/12/13/14/15/18/
19/20/22/23/24/25/27/
28/29/30/32/35/37 mm



• P. 77-82



Thickness:

1.4/1.5/1.6/1.8/2.0/2.2/2.5/2.7/3.0/3.2/
3.5/4.0/4.2/4.5/5.0/5.2/5.5/6.0/8.0 mm

Dia. 32/35/40/50/60/80 mm



• P. 83-85



Thickness:

4/5/6/7/8/10/12 mm

Dia. 50/60/80 mm



• P. 86



Radius:

R4/R5/R6 mm

Dia. 60/80 mm



3T Insert Design

Tapered Polygon Positioning + Coarse Pitch Design

Applications

For the following machining scenarios, T-slot cutters with coarse-pitch insert will generate less machining resistance compared to the close-pitch insert design, it leads to a better machining efficiency :



1. Machining exceptionally wide slots.
2. Machining in long overhang.
3. Larger cutting depths.
4. Machining difficult materials.



← C Series → ← CN Series → ← N Series → ←

1

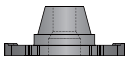

2

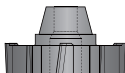

3

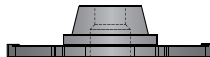

4

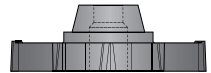

- $\varnothing 22 / \varnothing 27 / \varnothing 32 / \varnothing 35 / \varnothing 37$
- AE: 0.5 mm - 8.0 mm
- Max. AR10 mm



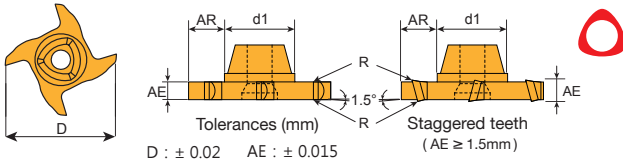

UFO T-slot Inserts

- Toolholders P. 24
- Cutting Data P. 135 - 136



Dimensions (mm)				
D	d1	AE	Max. AR	R
10	6.5	0.5-0.6	1.5	R0.05 ± 0.025
		0.7-0.8		
		0.9-1.0		
		1.1-1.2		
		1.3-1.4		
		1.5-1.6		
		1.7-1.8		
		1.9-2.0		
		2.2-2.5		
		3.0		

* Only "ME, B100 & ME, F20" insert are designed with corner radius.

Inserts	Order Code	Grades								
		Carbide					Cermet		Uncoated	
		B100	C200	C250	F20	F30	CE100	CE60	K10	CE
 <p>4 flutes</p>	3T0610-0.5-E									
	3T0610-0.6-E									
	3T0610-0.7-E									
	3T0610-0.8-E									
	3T0610-0.9-E									
	3T0610-1.0-E									
	3T0610-1.1-E									
	3T0610-1.2-E									
	3T0610-1.3-E									
	3T0610-1.4-E									
	3T0610-1.5-E									
	3T0610-1.6-E									
	3T0610-1.7-E									
	3T0610-1.8-E									
	3T0610-1.9-E									
3T0610-2.0-E										
3T0610-2.2-E										
3T0610-2.5-E										
3T0610-3.0-E										
 <p>4 flutes</p>	3T0610-0.5-ME	☉								
	3T0610-0.6-ME	☉								
	3T0610-0.7-ME	☉								
	3T0610-0.8-ME	☉								
	3T0610-0.9-ME	☉								
	3T0610-1.0-ME	☉								
	3T0610-1.1-ME	☉								
	3T0610-1.2-ME	☉								
	3T0610-1.3-ME	☉								
	3T0610-1.4-ME	☉								
	3T0610-1.5-ME	☉								
	3T0610-1.6-ME	☉								
	3T0610-1.7-ME	☉								
	3T0610-1.8-ME	☉								
	3T0610-1.9-ME	☉								
3T0610-2.0-ME	☉									
3T0610-2.2-ME	☉									
3T0610-2.5-ME	☉									
3T0610-3.0-ME	☉									

* M.O.Q: 12PCS
 * Make-to-Order.

- ■ Steel ■ Stainless Steel ☉ Steel/Stainless Steel/Super alloy ■ Cast Iron ■ Aluminum ■ Steel/Cast Iron
- ☉ Steel/Stainless Steel/Cast Iron
- Prices and stocks are based on present conditions
- Please specify model numbers and the grade of inserts, ie.: 3T0610-0.5-E,K10

UFO T-slot Inserts

- Toolholders P. 24
- Cutting Data P. 135 - 136

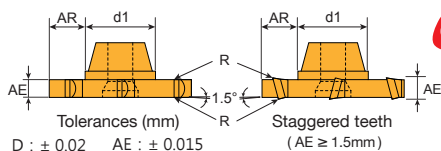

Dimensions (mm)				
D	d1	AE	Max. AR	R
11	6.5	0.5-0.6	2.0	R0.05 ± 0.025
		0.7-0.8		
		0.9-1.0		
		1.1-1.2		
		1.3-1.4		
		1.5-1.6		
		1.7-1.8		
		1.9-2.0		
		2.2-2.5		
		3.0		

* Only "ME, B100 & ME, F20" insert are designed with corner radius.

UFO Family

Inserts	Order Code	Grades												
		Carbide				Cermet		Uncoated						
		B100	C200	C250	F20	F30	CE100	CE60	K10		CE			
<p>4 flutes</p>	3T0611-0.5-E													
	3T0611-0.6-E													
	3T0611-0.7-E													
	3T0611-0.8-E													
	3T0611-0.9-E													
	3T0611-1.0-E													
	3T0611-1.1-E													
	3T0611-1.2-E													
	3T0611-1.3-E													
	3T0611-1.4-E													
	3T0611-1.5-E													
	3T0611-1.6-E													
	3T0611-1.7-E													
	3T0611-1.8-E													
	3T0611-1.9-E													
3T0611-2.0-E														
3T0611-2.2-E														
3T0611-2.5-E														
3T0611-3.0-E														
<p>4 flutes</p>	3T0611-0.5-ME	☉												
	3T0611-0.6-ME	☉												
	3T0611-0.7-ME	☉												
	3T0611-0.8-ME	☉												
	3T0611-0.9-ME	☉												
	3T0611-1.0-ME	☉												
	3T0611-1.1-ME	☉												
	3T0611-1.2-ME	☉												
	3T0611-1.3-ME	☉												
	3T0611-1.4-ME	☉												
	3T0611-1.5-ME	☉												
	3T0611-1.6-ME	☉												
	3T0611-1.7-ME	☉												
	3T0611-1.8-ME	☉												
	3T0611-1.9-ME	☉												
3T0611-2.0-ME	☉													
3T0611-2.2-ME	☉													
3T0611-2.5-ME	☉													
3T0611-3.0-ME	☉													

* M.O.Q: 12PCS
* Make-to-Order.

- ■ Steel ■ Stainless Steel ☉ Steel/Stainless Steel/Super alloy ■ Cast Iron ■ Aluminum ■ Steel/Cast Iron
- ☉ Steel/Stainless Steel/Cast Iron
- Prices and stocks are based on present conditions
- Please specify model numbers and the grade of inserts, ie.: 3T0611-0.5-E,K10







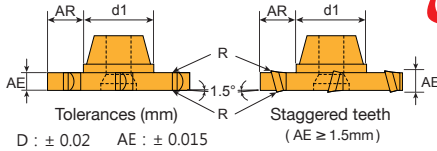













UFO T-slot Inserts

- Toolholders P. 24
- Cutting Data P. 135 - 136









Dimensions (mm)				
D	d1	AE	Max. AR	R
12	6.5	0.5-0.6	2.5	R0.05 ± 0.025
		0.7-0.8		
		0.9-1.0		
		1.1-1.2		
		1.3-1.4		
		1.5-1.6		
		1.7-1.8		
		1.9-2.0		
		2.2-2.5		
3.0				

* Only "ME, B100 & ME, F20" insert are designed with corner radius.

Inserts	Order Code	Grades								 								
		Carbide					Cermet		Uncoated									
		B100	C200	C250	F20	F30	CE100	CE60	K10		CE							
 <p>4 flutes</p>	3T0612-0.5-E											<table border="1"> <tr> <td></td> <td></td> </tr> <tr> <td></td> <td></td> </tr> <tr> <td></td> <td></td> </tr> </table>						
																		
																		
																		
	3T0612-0.6-E																	
	3T0612-0.7-E																	
	3T0612-0.8-E																	
	3T0612-0.9-E																	
	3T0612-1.0-E																	
	3T0612-1.1-E																	
	3T0612-1.2-E																	
	3T0612-1.3-E																	
	3T0612-1.4-E																	
3T0612-1.5-E																		
3T0612-1.6-E																		
3T0612-1.7-E																		
3T0612-1.8-E																		
3T0612-1.9-E																		
3T0612-2.0-E																		
3T0612-2.2-E																		
3T0612-2.5-E																		
3T0612-3.0-E																		
 <p>4 flutes</p>	3T0612-0.5-ME	⊗																
	3T0612-0.6-ME	⊗																
	3T0612-0.7-ME	⊗																
	3T0612-0.8-ME	⊗																
	3T0612-0.9-ME	⊗																
	3T0612-1.0-ME	⊗																
	3T0612-1.1-ME	⊗																
	3T0612-1.2-ME	⊗																
	3T0612-1.3-ME	⊗																
	3T0612-1.4-ME	⊗																
	3T0612-1.5-ME	⊗																
	3T0612-1.6-ME	⊗																
	3T0612-1.7-ME	⊗																
3T0612-1.8-ME	⊗																	
3T0612-1.9-ME	⊗																	
3T0612-2.0-ME	⊗																	
3T0612-2.2-ME	⊗																	
3T0612-2.5-ME	⊗																	
3T0612-3.0-ME	⊗																	

Inserts 6 PCS / Box

-  Steel  Stainless Steel  Steel/Stainless Steel/Super alloy  Cast Iron  Aluminum  Steel/Cast Iron
-  Steel/Stainless Steel/Cast Iron
- Prices and stocks are based on present conditions
- Please specify model numbers and the grade of inserts, ie.: 3T0612-0.5-E,K10

UFO T-slot Inserts

- Toolholders P. 25
- Cutting Data P. 135 - 136

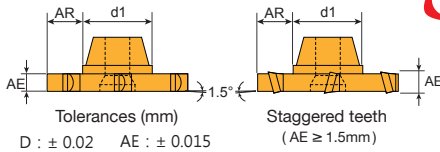

Dimensions (mm)			
D	d1	AE	Max. AR
13	7.9	0.5-0.6	2.0
		0.7-0.8	
		0.9-1.0	
		1.1-1.2	
		1.3-1.4	
		1.5-1.6	
		1.7-1.8	
		1.9-2.0	
		2.2-2.5	
		3.0	
4.0			

Inserts	Order Code	Grades									
		Carbide					Cermet		Uncoated		
		B100	C200	C250	F20	F30	CE100	CE60	K10		CE
 4 flutes	3T0813-0.5-E										
	3T0813-0.6-E										
	3T0813-0.7-E										
	3T0813-0.8-E										
	3T0813-0.9-E										
	3T0813-1.0-E										
	3T0813-1.1-E										
	3T0813-1.2-E										
	3T0813-1.3-E										
	3T0813-1.4-E										
	3T0813-1.5-E										
	3T0813-1.6-E										
	3T0813-1.7-E										
	3T0813-1.8-E										
	3T0813-1.9-E										
	3T0813-2.0-E										
3T0813-2.2-E											
3T0813-2.5-E											
3T0813-3.0-E											
3T0813-4.0-E											

* M.O.Q: 12PCS
* Make-to-Order.

- ■ Steel ■ Stainless Steel ■ Steel/Stainless Steel/Super alloy ■ Cast Iron ■ Aluminum ■ Steel/Cast Iron
- ■ Steel/Stainless Steel/Cast Iron
- Prices and stocks are based on present conditions
- Please specify model numbers and the grade of inserts, ie.: 3T0813-0.5-E,K10



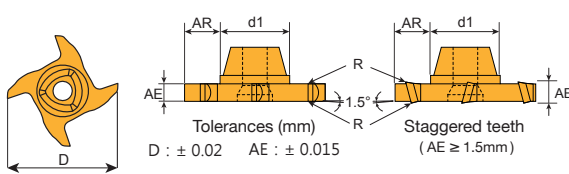

UFO T-slot Inserts

- Toolholders P. 25
- Cutting Data P. 135 - 136



Dimensions (mm)				
D	d1	AE	Max. AR	R
13	7.9	0.5-0.6	2.0	R0.05 ± 0.025
		0.7-0.8		
		0.9-1.0		
		1.1-1.2		
		1.3-1.4		
		1.5-1.6		
		1.7-1.8		
		1.9-2.0		
		2.2-2.5		
		3.0		
4.0				

Inserts	Order Code	Grades										
		Carbide					Cermet	Uncoated				
		B100	C200	C250	F20	F30	CE100	CE60	K10	CE		
 4 flutes	3T0813-0.5-ME	☉										
	3T0813-0.6-ME	☉										
	3T0813-0.7-ME	☉										
	3T0813-0.8-ME	☉										
	3T0813-0.9-ME	☉										
	3T0813-1.0-ME	☉										
	3T0813-1.1-ME	☉										
	3T0813-1.2-ME	☉										
	3T0813-1.3-ME	☉										
	3T0813-1.4-ME	☉										
	3T0813-1.5-ME	☉										
	3T0813-1.6-ME	☉										
	3T0813-1.7-ME	☉										
	3T0813-1.8-ME	☉										
	3T0813-1.9-ME	☉										
	3T0813-2.0-ME	☉										
3T0813-2.2-ME	☉											
3T0813-2.5-ME	☉											
3T0813-3.0-ME	☉											
3T0813-4.0-ME	☉											

* M.O.Q: 12PCS
* Make-to-Order.

- ■ Steel ■ Stainless Steel ☉ Steel/Stainless Steel/Super alloy ■ Cast Iron ■ Aluminum ■ Steel/Cast Iron
- ☉ Steel/Stainless Steel/Cast Iron
- Prices and stocks are based on present conditions
- Please specify model numbers and the grade of inserts, ie.: 3T0813-0.5-ME,B100

UFO T-slot Inserts

- Toolholders P. 25
- Cutting Data P. 135 - 136

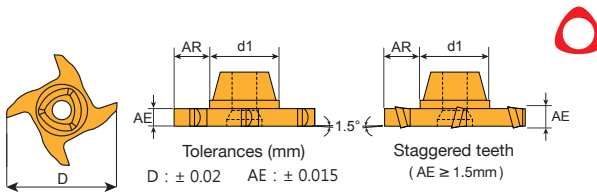

Dimensions (mm)			
D	d1	AE	Max. AR
14	7.9	0.5-0.6	2.5
		0.7-0.8	
		0.9-1.0	
		1.1-1.2	
		1.3-1.4	
		1.5-1.6	
		1.7-1.8	
		1.9-2.0	
		2.2-2.5	
		3.0	
4.0			

Inserts	Order Code	Grades											
		Carbide					Cermet	Uncoated					
		B100	C200	C250	F20	F30	CE100	CE60	K10	CE			
<p>4 flutes</p>	3T0814-0.5-E												<p>* M.O.Q: 12PCS</p> <p>* Make-to-Order.</p>
	3T0814-0.6-E												
	3T0814-0.7-E												
	3T0814-0.8-E												
	3T0814-0.9-E												
	3T0814-1.0-E												
	3T0814-1.1-E												
	3T0814-1.2-E												
	3T0814-1.3-E												
	3T0814-1.4-E												
	3T0814-1.5-E												
	3T0814-1.6-E												
	3T0814-1.7-E												
	3T0814-1.8-E												
	3T0814-1.9-E												
	3T0814-2.0-E												
3T0814-2.2-E													
3T0814-2.5-E													
3T0814-3.0-E													
3T0814-4.0-E													

- ■ Steel ■ Stainless Steel ■ Steel/Stainless Steel/Super alloy ■ Cast Iron ■ Aluminum ■ Steel/Cast Iron
- ■ Steel/Stainless Steel/Cast Iron
- Prices and stocks are based on present conditions
- Please specify model numbers and the grade of inserts, ie.: 3T0814-0.5-E,K10



UFO T-slot Inserts

- Toolholders P. 25
- Cutting Data P. 135 - 136

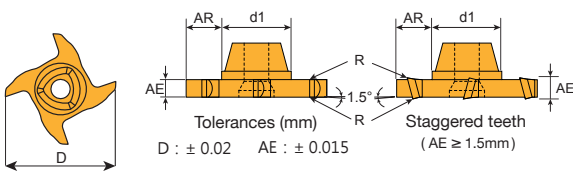

Dimensions (mm)				
D	d1	AE	Max. AR	R
14	7.9	0.5-0.6	2.5	R0.05 ± 0.025
		0.7-0.8		
		0.9-1.0		
		1.1-1.2		
		1.3-1.4		
		1.5-1.6		
		1.7-1.8		
		1.9-2.0		
		2.2-2.5		
		3.0		
4.0				

Inserts	Order Code	Grades									
		Carbide				Cermet	Uncoated				
		B100	C200	C250	F20	F30	CE100	CE60	K10		CE
 4 flutes	3T0814-0.5-ME	☉									
	3T0814-0.6-ME	☉									
	3T0814-0.7-ME	☉									
	3T0814-0.8-ME	☉									
	3T0814-0.9-ME	☉									
	3T0814-1.0-ME	☉									
	3T0814-1.1-ME	☉									
	3T0814-1.2-ME	☉									
	3T0814-1.3-ME	☉									
	3T0814-1.4-ME	☉									
	3T0814-1.5-ME	☉									
	3T0814-1.6-ME	☉									
	3T0814-1.7-ME	☉									
	3T0814-1.8-ME	☉									
	3T0814-1.9-ME	☉									
	3T0814-2.0-ME	☉									
3T0814-2.2-ME	☉										
3T0814-2.5-ME	☉										
3T0814-3.0-ME	☉										
3T0814-4.0-ME	☉										

* M.O.Q: 12PCS
* Make-to-Order.

- ■ Steel ■ Stainless Steel ☉ Steel/Stainless Steel/Super alloy ■ Cast Iron ■ Aluminum ■ Steel/Cast Iron
- ☉ Steel/Stainless Steel/Cast Iron
- Prices and stocks are based on present conditions
- Please specify model numbers and the grade of inserts, ie.: 3T0814-0.5-ME,B100



UFO T-slot Inserts

- Toolholders P. 25
- Cutting Data P. 135 - 136

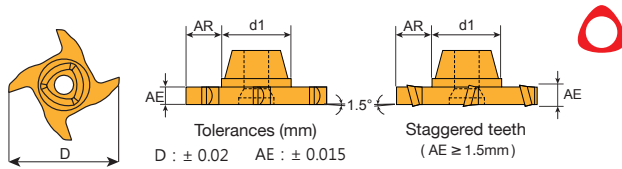
UFO Family



Dimensions (mm)			
D	d1	AE	Max. AR
15	7.9	0.5-0.6	3.0
		0.7-0.8	
		0.9-1.0	
		1.1-1.2	
		1.3-1.4	
		1.5-1.6	
		1.7-1.8	
		1.9-2.0	
		2.2-2.5	
		3.0	
4.0			

Inserts	Order Code	Grades									
		Carbide					Cermet		Uncoated		
		B100	C200	C250	F20	F30	CE100	CE60	K10		CE
 <p>4 flutes</p>	3T0815-0.5-E										
	3T0815-0.6-E										
	3T0815-0.7-E										
	3T0815-0.8-E										
	3T0815-0.9-E										
	3T0815-1.0-E										
	3T0815-1.1-E										
	3T0815-1.2-E										
	3T0815-1.3-E										
	3T0815-1.4-E										
	3T0815-1.5-E										
	3T0815-1.6-E										
	3T0815-1.7-E										
	3T0815-1.8-E										
	3T0815-1.9-E										
	3T0815-2.0-E										
3T0815-2.2-E											
3T0815-2.5-E											
3T0815-3.0-E											
3T0815-4.0-E											

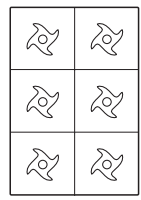

Inserts 6 PCS / Box

- ■ Steel ■ Stainless Steel ■ Steel/Stainless Steel/Super alloy ■ Cast Iron ■ Aluminum ■ Steel/Cast Iron
- ⊗ Steel/Stainless Steel/Cast Iron
- Prices and stocks are based on present conditions
- Please specify model numbers and the grade of inserts, ie.: 3T0815-0.5-E,K10



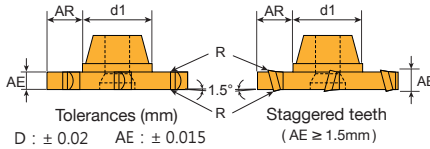

UFO T-slot Inserts

- Toolholders P. 25
- Cutting Data P. 135 - 136







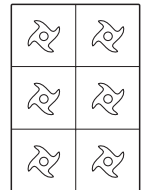

Dimensions (mm)				
D	d1	AE	Max. AR	R
15	7.9	0.5-0.6	3.0	R0.05 ± 0.025
		0.7-0.8		
		0.9-1.0		
		1.1-1.2		
		1.3-1.4		
		1.5-1.6		
		1.7-1.8		
		1.9-2.0		
		2.2-2.5		
		3.0		
4.0				

Inserts	Order Code	Grades										
		Carbide					Cermet			Uncoated		
		B100	C200	C250	F20	F30	CE100	CE60		K10	CE	
	3T0815-0.5-ME	☉										
	3T0815-0.6-ME	☉										
	3T0815-0.7-ME	☉										
	3T0815-0.8-ME	☉										
	3T0815-0.9-ME	☉										
	3T0815-1.0-ME	☉										
	3T0815-1.1-ME	☉										
	3T0815-1.2-ME	☉										
	3T0815-1.3-ME	☉										
	3T0815-1.4-ME	☉										
	3T0815-1.5-ME	☉										
	3T0815-1.6-ME	☉										
	3T0815-1.7-ME	☉										
	3T0815-1.8-ME	☉										
	3T0815-1.9-ME	☉										
	3T0815-2.0-ME	☉										
3T0815-2.2-ME	☉											
3T0815-2.5-ME	☉											
3T0815-3.0-ME	☉											
3T0815-4.0-ME	☉											



Inserts 6 PCS / Box

-  Steel  Stainless Steel  Steel/Stainless Steel/Super alloy  Cast Iron  Aluminum  Steel/Cast Iron
-  Steel/Stainless Steel/Cast Iron
- Prices and stocks are based on present conditions
- Please specify model numbers and the grade of inserts, ie.: 3T0815-0.5-ME,B100

UFO T-slot Inserts

- Toolholders P. 26
- Cutting Data P. 135 - 136

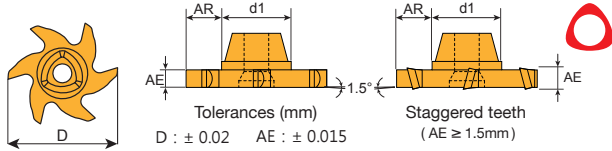

Dimensions (mm)			
D	d1	AE	Max. AR
18	10	0.5-0.6	3.5
		0.7-0.8	
		0.9-1.0	
		1.1-1.2	
		1.3-1.4	
		1.5-1.6	
		1.7-1.8	
		1.9-2.0	
		2.2-2.5	
		3.0-4.0	
		4.2-5.0	
6.0			
8.0			

UFO Family

Inserts	Order Code	Grades									
		Carbide				Cermet		Uncoated			
		B100	C200	C250	F20	F30	CE100	CE60	K10		CE
 6 flutes	3T1018-0.5-E										
	3T1018-0.6-E										
	3T1018-0.7-E										
	3T1018-0.8-E										
	3T1018-0.9-E										
	3T1018-1.0-E										
	3T1018-1.1-E										
	3T1018-1.2-E										
	3T1018-1.3-E										
	3T1018-1.4-E										
	3T1018-1.5-E										
	3T1018-1.6-E										
	3T1018-1.7-E										
	3T1018-1.8-E										
	3T1018-1.9-E										
	3T1018-2.0-E										
	3T1018-2.2-E										
	3T1018-2.5-E										
	3T1018-3.0-E										
	3T1018-3.5-E										
3T1018-4.0-E											
3T1018-4.2-E											
3T1018-4.5-E											
3T1018-5.0-E											
3T1018-6.0-E											
3T1018-8.0-E											

* M.O.Q: 12PCS
* Make-to-Order.

- ■ Steel ■ Stainless Steel ■ Steel/Stainless Steel/Super alloy ■ Cast Iron ■ Aluminum ■ Steel/Cast Iron
- ⊗ Steel/Stainless Steel/Cast Iron
- Prices and stocks are based on present conditions
- Please specify model numbers and the grade of inserts, ie.: 3T1018-0.5-E,K10



UFO T-slot Inserts

- Toolholders P. 26
- Cutting Data P. 135 - 136

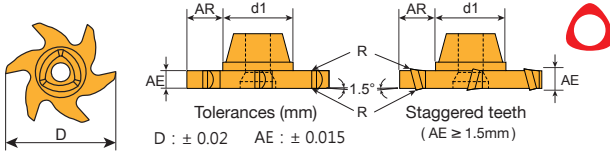

Dimensions (mm)				
D	d1	AE	Max. AR	R
18	10	0.5-0.6	3.5	R0.05 ± 0.025
		0.7-0.8		
		0.9-1.0		
		1.1-1.2		
		1.3-1.4		
		1.5-1.6		
		1.7-1.8		
		1.9-2.0		
		2.2-2.5		
		3.0-4.0		
		4.2-5.0		
		6.0		
8.0				

Inserts	Order Code	Grades									
		Carbide				Cermet		Uncoated			
		B100	C200	CZ50	F20	F50	CE100	CE60	K10		CE
	3T1018-0.5-ME	☉									
	3T1018-0.6-ME	☉									
	3T1018-0.7-ME	☉									
	3T1018-0.8-ME	☉									
	3T1018-0.9-ME	☉									
	3T1018-1.0-ME	☉									
	3T1018-1.1-ME	☉									
	3T1018-1.2-ME	☉									
	3T1018-1.3-ME	☉									
	3T1018-1.4-ME	☉									
	3T1018-1.5-ME	☉									
	3T1018-1.6-ME	☉									
	3T1018-1.7-ME	☉									
	3T1018-1.8-ME	☉									
	3T1018-1.9-ME	☉									
	3T1018-2.0-ME	☉									
	3T1018-2.2-ME	☉									
	3T1018-2.5-ME	☉									
	3T1018-3.0-ME	☉									
	3T1018-3.5-ME	☉									
	3T1018-4.0-ME	☉									
	3T1018-4.2-ME	☉									
	3T1018-4.5-ME	☉									
	3T1018-5.0-ME	☉									
	3T1018-6.0-ME	☉									
	3T1018-8.0-ME	☉									



6 flutes

* M.O.Q: 12PCS
* Make-to-Order.

- ■ Steel ■ Stainless Steel ☉ Steel/Stainless Steel/Super alloy ■ Cast Iron ■ Aluminum ■ Steel/Cast Iron
- ☉ Steel/Stainless Steel/Cast Iron

- Prices and stocks are based on present conditions
- Please specify model numbers and the grade of inserts, ie.: 3T1018-0.5-ME,B100

UFO T-slot Inserts

- Toolholders P. 26
- Cutting Data P. 135 - 136

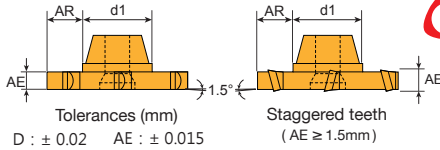

Dimensions (mm)			
D	d1	AE	Max. AR
19	10	0.5-0.6	4.0
		0.7-0.8	
		0.9-1.0	
		1.1-1.2	
		1.3-1.4	
		1.5-1.6	
		1.7-1.8	
		1.9-2.0	
		2.2-2.5	
		3.0-4.0	
4.2-5.0			
6.0			
8.0			

UFO Family

Inserts	Order Code	Grades								
		Carbide				Cermet		Uncoated		
		B100	C200	C250	F20	F30	CE100	CE60	K10	
	3T1019-0.5-E									
	3T1019-0.6-E									
	3T1019-0.7-E									
	3T1019-0.8-E									
	3T1019-0.9-E									
	3T1019-1.0-E									
	3T1019-1.1-E									
	3T1019-1.2-E									
	3T1019-1.3-E									
	3T1019-1.4-E									
	3T1019-1.5-E									
	3T1019-1.6-E									
	3T1019-1.7-E									
	3T1019-1.8-E									
	3T1019-1.9-E									
	3T1019-2.0-E									
	3T1019-2.2-E									
	3T1019-2.5-E									
	3T1019-3.0-E									
	3T1019-3.5-E									
	3T1019-4.0-E									
	3T1019-4.2-E									
	3T1019-4.5-E									
	3T1019-5.0-E									
	3T1019-6.0-E									
	3T1019-8.0-E									



6 flutes

* M.O.Q: 12PCS
* Make-to-Order.

- ■ Steel ■ Stainless Steel ⊗ Steel/Stainless Steel/Super alloy ■ Cast Iron ■ Aluminum ■ Steel/Cast Iron ⊗ Steel/Stainless Steel/Cast Iron
- Prices and stocks are based on present conditions
- Please specify model numbers and the grade of inserts, ie.: 3T1019-0.5-E,K10



UFO T-slot Inserts

- Toolholders P. 26
- Cutting Data P. 135 - 136

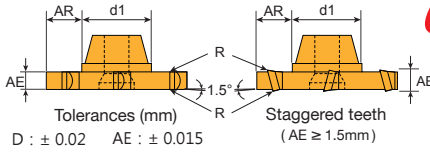

Dimensions (mm)				
D	d1	AE	Max. AR	R
19	10	0.5-0.6	4.0	R0.05 ± 0.025
		0.7-0.8		
		0.9-1.0		
		1.1-1.2		
		1.3-1.4		
		1.5-1.6		
		1.7-1.8		
		1.9-2.0		
		2.2-2.5		
		3.0-4.0		
		6.0		
		8.0		

Inserts	Order Code	Grades									
		Carbide				Cermet		Uncoated			
		B100	C200	C250	F20	F30	CE100	CE60	K10		CE
	3T1019-0.5-ME	☉									
	3T1019-0.6-ME	☉									
	3T1019-0.7-ME	☉									
	3T1019-0.8-ME	☉									
	3T1019-0.9-ME	☉									
	3T1019-1.0-ME	☉									
	3T1019-1.1-ME	☉									
	3T1019-1.2-ME	☉									
	3T1019-1.3-ME	☉									
	3T1019-1.4-ME	☉									
	3T1019-1.5-ME	☉									
	3T1019-1.6-ME	☉									
	3T1019-1.7-ME	☉									
	3T1019-1.8-ME	☉									
	3T1019-1.9-ME	☉									
	3T1019-2.0-ME	☉									
	3T1019-2.2-ME	☉									
	3T1019-2.5-ME	☉									
	3T1019-3.0-ME	☉									
	3T1019-3.5-ME	☉									
	3T1019-4.0-ME	☉									
	3T1019-4.2-ME	☉									
	3T1019-4.5-ME	☉									
	3T1019-5.0-ME	☉									
	3T1019-6.0-ME	☉									
	3T1019-8.0-ME	☉									

* M.O.Q: 12PCS
* Make-to-Order.

- ■ Steel ■ Stainless Steel ⊗ Steel/Stainless Steel/Super alloy ■ Cast Iron ■ Aluminum ■ Steel/Cast Iron ⊗ Steel/Stainless Steel/Cast Iron
- Prices and stocks are based on present conditions
- Please specify model numbers and the grade of inserts, ie.: 3T1019-0.5-ME,B100

UFO T-slot Inserts

- Toolholders P. 26
- Cutting Data P. 135 - 136

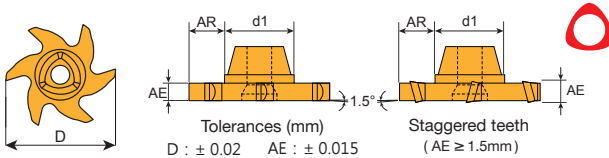

Dimensions (mm)			
D	d1	AE	Max. AR
20	10	0.5-0.6	4.5
		0.7-0.8	
		0.9-1.0	
		1.1-1.2	
		1.3-1.4	
		1.5-1.6	
		1.7-1.8	
		1.9-2.0	
		2.2-2.5	
		3.0-4.0	
4.2-5.0			
6.0			
8.0			

UFO Family

Inserts	Order Code	Grades									
		Carbide					Cermet	Uncoated			
		B100	C200	C250	F20	F30	CE100	CE60	K10		CE
	3T1020-0.5-E										
	3T1020-0.6-E										
	3T1020-0.7-E										
	3T1020-0.8-E										
	3T1020-0.9-E										
	3T1020-1.0-E										
	3T1020-1.1-E										
	3T1020-1.2-E										
	3T1020-1.3-E										
	3T1020-1.4-E										
	3T1020-1.5-E										
	3T1020-1.6-E										
	3T1020-1.7-E										
	3T1020-1.8-E										
	3T1020-1.9-E										
	3T1020-2.0-E										
	3T1020-2.2-E										
	3T1020-2.5-E										
	3T1020-3.0-E										
	3T1020-3.5-E										
	3T1020-4.0-E										
	3T1020-4.2-E										
	3T1020-4.5-E										
	3T1020-5.0-E										
	3T1020-6.0-E										
	3T1020-8.0-E										



6 flutes

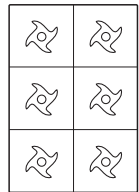

Inserts 6 PCS / Box

- ■ Steel ■ Stainless Steel ■ Steel/Stainless Steel/Super alloy ■ Cast Iron ■ Aluminum ■ Steel/Cast Iron ■ Steel/Stainless Steel/Cast Iron
- Prices and stocks are based on present conditions
- Please specify model numbers and the grade of inserts, ie.: 3T1020-0.5-E,K10



UFO T-slot Inserts

- Toolholders P. 26
- Cutting Data P. 135 - 136

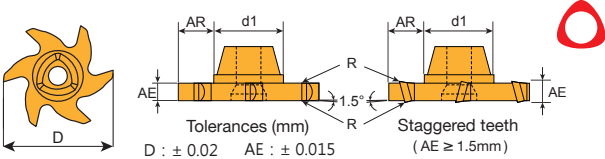

Dimensions (mm)				
D	d1	AE	Max. AR	R
20	10	0.5-0.6	4.5	R0.05 ± 0.025
		0.7-0.8		
		0.9-1.0		
		1.1-1.2		
		1.3-1.4		
		1.5-1.6		
		1.7-1.8		
		1.9-2.0		
		2.2-2.5		
		3.0-4.0		
		4.2-5.0		
6.0				
8.0				

Inserts	Order Code	Grades									
		Carbide				Cermet		Uncoated			
		B100	C200	C250	F20	F30	CE100	CE60	K10		CE
	3T1020-0.5-ME	⊙									
	3T1020-0.6-ME	⊙									
	3T1020-0.7-ME	⊙									
	3T1020-0.8-ME	⊙									
	3T1020-0.9-ME	⊙									
	3T1020-1.0-ME	⊙									
	3T1020-1.1-ME	⊙									
	3T1020-1.2-ME	⊙									
	3T1020-1.3-ME	⊙									
	3T1020-1.4-ME	⊙									
	3T1020-1.5-ME	⊙									
	3T1020-1.6-ME	⊙									
	3T1020-1.7-ME	⊙									
	3T1020-1.8-ME	⊙									
	3T1020-1.9-ME	⊙									
	3T1020-2.0-ME	⊙									
	3T1020-2.2-ME	⊙									
	3T1020-2.5-ME	⊙									
	3T1020-3.0-ME	⊙									
	3T1020-3.5-ME	⊙									
	3T1020-4.0-ME	⊙									
	3T1020-4.2-ME	⊙									
	3T1020-4.5-ME	⊙									
	3T1020-5.0-ME	⊙									
	3T1020-6.0-ME	⊙									
	3T1020-8.0-ME	⊙									



6 flutes

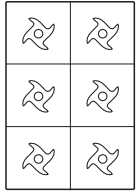

Inserts 6 PCS / Box

- ■ Steel ■ Stainless Steel ⊙ Steel/Stainless Steel/Super alloy ■ Cast Iron ■ Aluminum ■ Steel/Cast Iron
- ⊙ Steel/Stainless Steel/Cast Iron
- Prices and stocks are based on present conditions
- Please specify model numbers and the grade of inserts, ie.: 3T1020-0.5-ME,B100

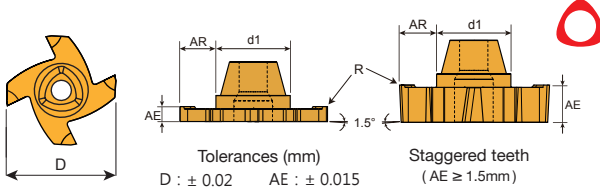

UFO T-slot Inserts

- Toolholders P. 26
- Cutting Data P. 135 - 136



Dimensions (mm)				
D	d1	AE	Max. AR	R
22	10	0.5-0.6	5.5	R0.05 ± 0.025
		0.7-0.8		
		0.9-1.0		
		1.1-1.2		
		1.3-1.4		
		1.5-1.6		
		1.7-1.8		
		1.9-2.0		
		2.2-2.5		
		3.0-4.0		
		4.2-5.0		
		6.0		
		8.0		

UFO Family

Inserts	Order Code	Grades									
		Carbide					Cermet		Uncoated		
		B100	C200	C250	F20	F30	CE100	CE60	K10	CE	
 <p>4 flutes</p>	3T1022C-0.5-ME	⊙									
	3T1022C-0.6-ME	⊙									
	3T1022C-0.7-ME	⊙									
	3T1022C-0.8-ME	⊙									
	3T1022C-0.9-ME	⊙									
	3T1022C-1.0-ME	⊙									
	3T1022C-1.1-ME	⊙									
	3T1022C-1.2-ME	⊙									
	3T1022C-1.3-ME	⊙									
	3T1022C-1.4-ME	⊙									
	3T1022C-1.5-ME	⊙									
	3T1022C-1.6-ME	⊙									
	3T1022C-1.7-ME	⊙									
	3T1022C-1.8-ME	⊙									
	3T1022C-1.9-ME	⊙									
	3T1022C-2.0-ME	⊙									
	3T1022C-2.2-ME	⊙									
	3T1022C-2.5-ME	⊙									
	3T1022C-3.0-ME	⊙									
	3T1022C-3.5-ME	⊙									
3T1022C-4.0-ME	⊙										
3T1022C-4.2-ME	⊙										
3T1022C-4.5-ME	⊙										
3T1022C-5.0-ME	⊙										
3T1022C-6.0-ME	⊙										
3T1022C-8.0-ME	⊙										

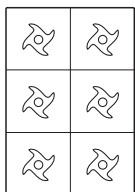

Inserts 6 PCS / Box

-  Steel / Stainless Steel / Super alloy / Cast Iron
- Prices and stocks are based on present conditions
- Please specify model numbers and the grade of inserts, ie.: 3T1022C-0.5-ME, B100



UFO T-slot Inserts



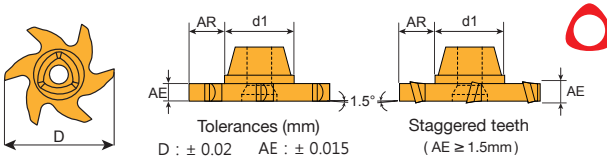



- Toolholders P. 27
- Cutting Data P. 135 - 136



Dimensions (mm)			
D	d1	AE	Max. AR
23	12	0.5-0.6	5.0
		0.7-0.8	
		0.9-1.0	
		1.1-1.2	
		1.3-1.4	
		1.5-1.6	
		1.7-1.8	
		1.9-2.0	
		2.2-2.5	
		3.0-4.0	
4.2-5.0			
6.0			
8.0			

Inserts	Order Code	Grades											
		Carbide					Cermet	Uncoated					
		B100	C200	C250	F20	F30	CE100	CE60	K10		CE		
 <p>6 flutes</p>	3T1223-0.5-E												
	3T1223-0.6-E												
	3T1223-0.7-E												
	3T1223-0.8-E												
	3T1223-0.9-E												
	3T1223-1.0-E												
	3T1223-1.1-E												
	3T1223-1.2-E												
	3T1223-1.3-E												
	3T1223-1.4-E												
	3T1223-1.5-E												
	3T1223-1.6-E												
	3T1223-1.7-E												
	3T1223-1.8-E												
	3T1223-1.9-E												
	3T1223-2.0-E												
	3T1223-2.2-E												
	3T1223-2.5-E												
	3T1223-3.0-E												
	3T1223-3.5-E												
3T1223-4.0-E													
3T1223-4.2-E													
3T1223-4.5-E													
3T1223-5.0-E													
3T1223-6.0-E													
3T1223-8.0-E													

* M.O.Q: 12PCS
* Make-to-Order.

-  Steel  Stainless Steel  Steel/Stainless Steel/Super alloy  Cast Iron  Aluminum  Steel/Cast Iron
-  Steel/Stainless Steel/Cast Iron
- Prices and stocks are based on present conditions
- Please specify model numbers and the grade of inserts, ie.: 3T1223-0.5-E,K10

UFO T-slot Inserts

- Toolholders P. 27
- Cutting Data P. 135 - 136

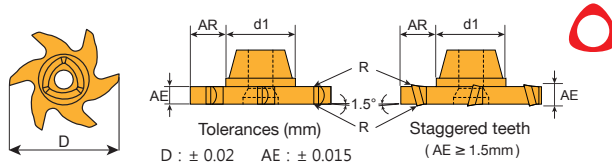

Dimensions (mm)				
D	d1	AE	Max. AR	R
23	12	0.5-0.6	5.0	R0.05 ± 0.025
		0.7-0.8		
		0.9-1.0		
		1.1-1.2		
		1.3-1.4		
		1.5-1.6		
		1.7-1.8		
		1.9-2.0		
		2.2-2.5		
		3.0-4.0		
		4.2-5.0		
		6.0		
		8.0		

UFO Family

Inserts	Order Code	Grades										
		Carbide					Cermet		Uncoated			
		B100	C200	C250	F20	F30	CE100	CE60	K10	CE		
	3T1223-0.5-ME	☉										
	3T1223-0.6-ME	☉										
	3T1223-0.7-ME	☉										
	3T1223-0.8-ME	☉										
	3T1223-0.9-ME	☉										
	3T1223-1.0-ME	☉										
	3T1223-1.1-ME	☉										
	3T1223-1.2-ME	☉										
	3T1223-1.3-ME	☉										
	3T1223-1.4-ME	☉										
	3T1223-1.5-ME	☉										
	3T1223-1.6-ME	☉										
	3T1223-1.7-ME	☉										
	3T1223-1.8-ME	☉										
	3T1223-1.9-ME	☉										
	3T1223-2.0-ME	☉										
	3T1223-2.2-ME	☉										
	3T1223-2.5-ME	☉										
	3T1223-3.0-ME	☉										
	3T1223-3.5-ME	☉										
	3T1223-4.0-ME	☉										
	3T1223-4.2-ME	☉										
	3T1223-4.5-ME	☉										
	3T1223-5.0-ME	☉										
	3T1223-6.0-ME	☉										
	3T1223-8.0-ME	☉										



* M.O.Q: 12PCS
* Make-to-Order.

- ■ Steel ■ Stainless Steel ☉ Steel/Stainless Steel/Super alloy ■ Cast Iron ■ Aluminum ■ Steel/Cast Iron ☉ Steel/Stainless Steel/Cast Iron
- Prices and stocks are based on present conditions
- Please specify model numbers and the grade of inserts, i.e.: 3T1223-0.5-ME,B100



UFO T-slot Inserts



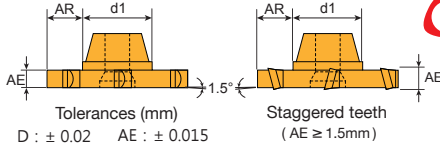



- Toolholders P. 27
- Cutting Data P. 135 - 136



Dimensions (mm)			
D	d1	AE	Max. AR
24	12	0.5-0.6	5.5
		0.7-0.8	
		0.9-1.0	
		1.1-1.2	
		1.3-1.4	
		1.5-1.6	
		1.7-1.8	
		1.9-2.0	
		2.2-2.5	
		3.0-4.0	
		4.2-5.0	
6.0			
8.0			

Inserts	Order Code	Grades												
		Carbide					Cermet		Uncoated					
		B100	C200	C250	F20	F30	CE100	CE60	K10		CE			
 <p>6 flutes</p>	3T1224-0.5-E													
	3T1224-0.6-E													
	3T1224-0.7-E													
	3T1224-0.8-E													
	3T1224-0.9-E													
	3T1224-1.0-E													
	3T1224-1.1-E													
	3T1224-1.2-E													
	3T1224-1.3-E													
	3T1224-1.4-E													
	3T1224-1.5-E													
	3T1224-1.6-E													
	3T1224-1.7-E													
	3T1224-1.8-E													
	3T1224-1.9-E													
	3T1224-2.0-E													
	3T1224-2.2-E													
	3T1224-2.5-E													
	3T1224-3.0-E													
	3T1224-3.5-E													
3T1224-4.0-E														
3T1224-4.2-E														
3T1224-4.5-E														
3T1224-5.0-E														
3T1224-6.0-E														
3T1224-8.0-E														

* M.O.Q: 12PCS
* Make-to-Order.

-  Steel  Stainless Steel  Steel/Stainless Steel/Super alloy  Cast Iron  Aluminum  Steel/Cast Iron
-  Steel/Stainless Steel/Cast Iron
- Prices and stocks are based on present conditions
- Please specify model numbers and the grade of inserts, ie.: 3T1224-0.5-E,K10

UFO T-slot Inserts

- Toolholders P. 27
- Cutting Data P. 135 - 136

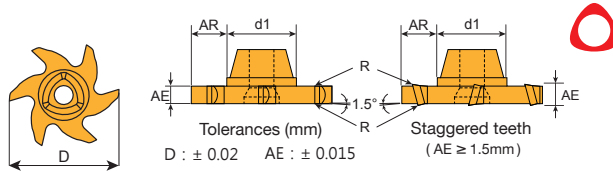

Dimensions (mm)				
D	d1	AE	Max. AR	R
24	12	0.5-0.6	5.5	R0.05 ± 0.025
		0.7-0.8		
		0.9-1.0		
		1.1-1.2		
		1.3-1.4		
		1.5-1.6		
		1.7-1.8		
		1.9-2.0		
		2.2-2.5		
		3.0-4.0		
		4.2-5.0		
		6.0		
8.0				

UFO Family

Inserts	Order Code	Grades									
		Carbide				Cermet		Uncoated			
		B100	C200	C250	F20	F30	CE100	CE60	K10		CE
	3T1224-0.5-ME	⊙									
	3T1224-0.6-ME	⊙									
	3T1224-0.7-ME	⊙									
	3T1224-0.8-ME	⊙									
	3T1224-0.9-ME	⊙									
	3T1224-1.0-ME	⊙									
	3T1224-1.1-ME	⊙									
	3T1224-1.2-ME	⊙									
	3T1224-1.3-ME	⊙									
	3T1224-1.4-ME	⊙									
	3T1224-1.5-ME	⊙									
	3T1224-1.6-ME	⊙									
	3T1224-1.7-ME	⊙									
	3T1224-1.8-ME	⊙									
	3T1224-1.9-ME	⊙									
	3T1224-2.0-ME	⊙									
	3T1224-2.2-ME	⊙									
	3T1224-2.5-ME	⊙									
	3T1224-3.0-ME	⊙									
	3T1224-3.5-ME	⊙									
	3T1224-4.0-ME	⊙									
	3T1224-4.2-ME	⊙									
	3T1224-4.5-ME	⊙									
	3T1224-5.0-ME	⊙									
	3T1224-6.0-ME	⊙									
	3T1224-8.0-ME	⊙									



6 flutes

* M.O.Q: 12PCS
* Make-to-Order.

- ■ Steel ■ Stainless Steel ⊗ Steel/Stainless Steel/Super alloy ■ Cast Iron ■ Aluminum ■ Steel/Cast Iron
- ⊗ Steel/Stainless Steel/Cast Iron
- Prices and stocks are based on present conditions
- Please specify model numbers and the grade of inserts, ie.: 3T1224-0.5-ME,B100



UFO T-slot Inserts

- Toolholders P. 27
- Cutting Data P. 135 - 136

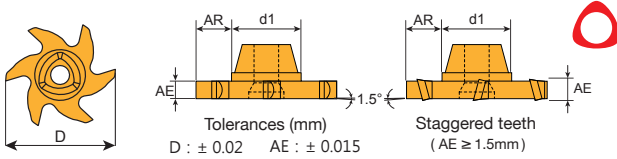

Dimensions (mm)			
D	d1	AE	Max. AR
25	12	0.5-0.6	6.0
		0.7-0.8	
		0.9-1.0	
		1.1-1.2	
		1.3-1.4	
		1.5-1.6	
		1.7-1.8	
		1.9-2.0	
		2.2-2.5	
		3.0-4.0	
		4.2-5.0	
6.0			
8.0			

Inserts	Order Code	Grades									
		Carbide				Cermet		Uncoated			
		B100	C200	C250	F20	F30	CE100	CE60	K10		CE
	3T1225-0.5-E										
	3T1225-0.6-E										
	3T1225-0.7-E										
	3T1225-0.8-E										
	3T1225-0.9-E										
	3T1225-1.0-E										
	3T1225-1.1-E										
	3T1225-1.2-E										
	3T1225-1.3-E										
	3T1225-1.4-E										
	3T1225-1.5-E										
	3T1225-1.6-E										
	3T1225-1.7-E										
	3T1225-1.8-E										
	3T1225-1.9-E										
	3T1225-2.0-E										
	3T1225-2.2-E										
	3T1225-2.5-E										
	3T1225-3.0-E										
	3T1225-3.5-E										
	3T1225-4.0-E										
	3T1225-4.2-E										
	3T1225-4.5-E										
	3T1225-5.0-E										
	3T1225-6.0-E										
	3T1225-8.0-E										

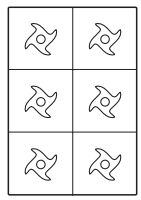

Inserts 6 PCS / Box

- ■ Steel ■ Stainless Steel ■ Steel/Stainless Steel/Super alloy ■ Cast Iron ■ Aluminum ■ Steel/Cast Iron
- ⊗ Steel/Stainless Steel/Cast Iron
- Prices and stocks are based on present conditions
- Please specify model numbers and the grade of inserts, ie.: 3T1225-0.5-E,K10

UFO T-slot Inserts

- Toolholders P. 27
- Cutting Data P. 135 - 136

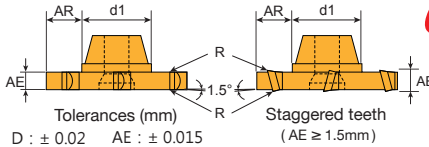
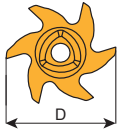

Dimensions (mm)				
D	d1	AE	Max. AR	R
25	12	0.5-0.6	6.0	R0.05 ± 0.025
		0.7-0.8		
		0.9-1.0		
		1.1-1.2		
		1.3-1.4		
		1.5-1.6		
		1.7-1.8		
		1.9-2.0		
		2.2-2.5		
		3.0-4.0		
		4.2-5.0		
6.0				
8.0				

UFO Family

Inserts	Order Code	Grades									
		Carbide				Cermet		Uncoated			
		B100	C200	C250	F20	F30	CE100	CE60	K10		CE
	3T1225-0.5-ME	⊙									
	3T1225-0.6-ME	⊙									
	3T1225-0.7-ME	⊙									
	3T1225-0.8-ME	⊙									
	3T1225-0.9-ME	⊙									
	3T1225-1.0-ME	⊙									
	3T1225-1.1-ME	⊙									
	3T1225-1.2-ME	⊙									
	3T1225-1.3-ME	⊙									
	3T1225-1.4-ME	⊙									
	3T1225-1.5-ME	⊙									
	3T1225-1.6-ME	⊙									
	3T1225-1.7-ME	⊙									
	3T1225-1.8-ME	⊙									
	3T1225-1.9-ME	⊙									
	3T1225-2.0-ME	⊙									
	3T1225-2.2-ME	⊙									
	3T1225-2.5-ME	⊙									
	3T1225-3.0-ME	⊙									
	3T1225-3.5-ME	⊙									
	3T1225-4.0-ME	⊙									
	3T1225-4.2-ME	⊙									
	3T1225-4.5-ME	⊙									
	3T1225-5.0-ME	⊙									
	3T1225-6.0-ME	⊙									
	3T1225-8.0-ME	⊙									



6 flutes

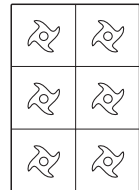

Inserts 6 PCS / Box

- ■ Steel ■ Stainless Steel ⊙ Steel/Stainless Steel/Super alloy ■ Cast Iron ■ Aluminum ■ Steel/Cast Iron
- ⊙ Steel/Stainless Steel/Cast Iron
- Prices and stocks are based on present conditions
- Please specify model numbers and the grade of inserts, ie.: 3T1225-0.5-ME,B100



UFO T-slot Inserts

- Toolholders P. 27
- Cutting Data P. 135 - 136

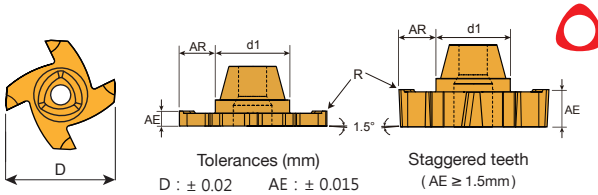

Dimensions (mm)				
D	d1	AE	Max. AR	R
27	12	0.8-0.9	7.0	$R0.05 \pm 0.025$
		1.0-1.1		
		1.2-1.3		
		1.4-1.5		
		1.6-1.8		
		1.9-2.0		
		2.2-2.5		
		3.0-4.0		
		4.2-5.0		
		6.0		
8.0				

Inserts	Order Code	Grades									
		Carbide					Cermet		Uncoated		
		B100	C200	C250	F-20	F-30	CE100	CE60	K10		CE
 <p>4 flutes</p>	3T1227C-0.8-ME	⊙									
	3T1227C-0.9-ME	⊙									
	3T1227C-1.0-ME	⊙									
	3T1227C-1.1-ME	⊙									
	3T1227C-1.2-ME	⊙									
	3T1227C-1.3-ME	⊙									
	3T1227C-1.4-ME	⊙									
	3T1227C-1.5-ME	⊙									
	3T1227C-1.6-ME	⊙									
	3T1227C-1.7-ME	⊙									
	3T1227C-1.8-ME	⊙									
	3T1227C-1.9-ME	⊙									
	3T1227C-2.0-ME	⊙									
	3T1227C-2.2-ME	⊙									
	3T1227C-2.5-ME	⊙									
	3T1227C-3.0-ME	⊙									
	3T1227C-3.5-ME	⊙									
	3T1227C-4.0-ME	⊙									
3T1227C-4.2-ME	⊙										
3T1227C-4.5-ME	⊙										
3T1227C-5.0-ME	⊙										
3T1227C-6.0-ME	⊙										
3T1227C-8.0-ME	⊙										



Inserts 6 PCS / Box

- ⊙ Steel / Stainless Steel / Super alloy / Cast Iron
- Prices and stocks are based on present conditions
- Please specify model numbers and the grade of inserts, ie.: 3T1227C-0.8-ME, B100

UFO T-slot Inserts

- Toolholders P. 28
- Cutting Data P. 135 - 136

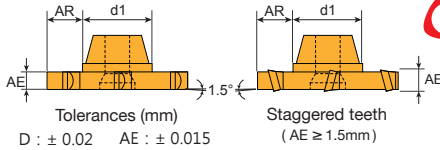

Dimensions (mm)			
D	d1	AE	Max. AR
28	16	0.8-0.9	5.5
		1.0-1.1	
		1.2-1.3	
		1.4-1.5	
		1.6-1.8	
		1.9-2.0	
		2.2-2.5	
		3.0-4.0	
		4.2-5.0	

UFO Family

Inserts	Order Code	Grades									
		Carbide				Cermet		Uncoated			
		B100	C200	C250	F20	F30	CE100	CE60		K10	CE
<p>8 flutes</p>	3T1628-0.8-E										<p>* M.O.Q: 12PCS</p> <p>* Make-to-Order.</p>
	3T1628-0.9-E										
	3T1628-1.0-E										
	3T1628-1.1-E										
	3T1628-1.2-E										
	3T1628-1.3-E										
	3T1628-1.4-E										
	3T1628-1.5-E										
	3T1628-1.6-E										
	3T1628-1.7-E										
	3T1628-1.8-E										
	3T1628-1.9-E										
	3T1628-2.0-E										
	3T1628-2.2-E										
	3T1628-2.5-E										
	3T1628-3.0-E										
	3T1628-3.5-E										
3T1628-4.0-E											
3T1628-4.2-E											
3T1628-4.5-E											
3T1628-5.0-E											

- ■ Steel ■ Stainless Steel ■ Steel/Stainless Steel/Super alloy ■ Cast Iron ■ Aluminum ■ Steel/Cast Iron
- ⊗ Steel/Stainless Steel/Cast Iron
- Prices and stocks are based on present conditions
- Please specify model numbers and the grade of inserts, ie.: 3T1628-0.8-E,K10



UFO T-slot Inserts

- Toolholders P. 28
- Cutting Data P. 135 - 136

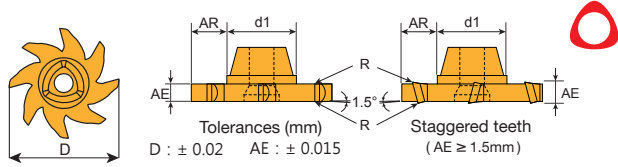

Dimensions (mm)				
D	d1	AE	Max. AR	R
28	16	0.8-0.9	5.5	R0.05 \pm 0.025
		1.0-1.1		
		1.2-1.3		
		1.4-1.5		
		1.6-1.8		
		1.9-2.0		
		2.2-2.5		
		3.0-4.0		
		4.2-5.0		

Inserts	Order Code	Grades									
		Carbide				Cermets		Uncoated			
		B100	C200	C250	F20	F30	CE100	CE60	K10		CE
	3T1628-0.8-ME	⊙									
	3T1628-0.9-ME	⊙									
	3T1628-1.0-ME	⊙									
	3T1628-1.1-ME	⊙									
	3T1628-1.2-ME	⊙									
	3T1628-1.3-ME	⊙									
	3T1628-1.4-ME	⊙									
	3T1628-1.5-ME	⊙									
	3T1628-1.6-ME	⊙									
	3T1628-1.7-ME	⊙									
	3T1628-1.8-ME	⊙									
	3T1628-1.9-ME	⊙									
	3T1628-2.0-ME	⊙									
	3T1628-2.2-ME	⊙									
	3T1628-2.5-ME	⊙									
	3T1628-3.0-ME	⊙									
	3T1628-3.5-ME	⊙									
	3T1628-4.0-ME	⊙									
	3T1628-4.2-ME	⊙									
	3T1628-4.5-ME	⊙									
	3T1628-5.0-ME	⊙									

* M.O.Q: 12PCS
 * Make-to-Order.

- Steel Stainless Steel Steel/Stainless Steel/Super alloy Cast Iron Aluminum Steel/Cast Iron
- Steel/Stainless Steel/Cast Iron
- Prices and stocks are based on present conditions
- Please specify model numbers and the grade of inserts, ie.: 3T1628-0.8-ME,B100

UFO T-slot Inserts

- Toolholders P. 28
- Cutting Data P. 135 - 136

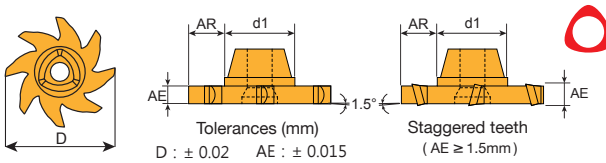

Dimensions (mm)			
D	d1	AE	Max. AR
29	16	0.8-0.9	6.0
		1.0-1.1	
		1.2-1.3	
		1.4-1.5	
		1.6-1.8	
		1.9-2.0	
		2.2-2.5	
		3.0-4.0	
		4.2-5.0	

Inserts	Order Code	Grades								
		Carbide					Cermet		Uncoated	
		B100	C200	C250	F20	F30	CE100	CE60	K10	
	3T1629-0.8-E									
	3T1629-0.9-E									
	3T1629-1.0-E									
	3T1629-1.1-E									
	3T1629-1.2-E									
	3T1629-1.3-E									
	3T1629-1.4-E									
	3T1629-1.5-E									
	3T1629-1.6-E									
	3T1629-1.7-E									
	3T1629-1.8-E									
	3T1629-1.9-E									
	3T1629-2.0-E									
	3T1629-2.2-E									
	3T1629-2.5-E									
	3T1629-3.0-E									
	3T1629-3.5-E									
	3T1629-4.0-E									
	3T1629-4.2-E									
	3T1629-4.5-E									
	3T1629-5.0-E									



8 flutes

* M.O.Q: 12PCS
* Make-to-Order.

- ■ Steel ■ Stainless Steel ■ Steel/Stainless Steel/Super alloy ■ Cast Iron ■ Aluminum ■ Steel/Cast Iron
- ■ Steel/Stainless Steel/Cast Iron
- Prices and stocks are based on present conditions
- Please specify model numbers and the grade of inserts, ie.: 3T1629-0.8-E,K10



UFO T-slot Inserts

- Toolholders P. 28
- Cutting Data P. 135 - 136

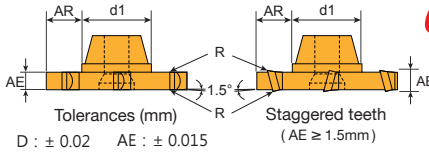
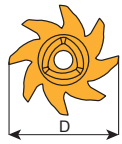

Dimensions (mm)				
D	d1	AE	Max. AR	R
29	16	0.8-0.9	6.0	R0.05 ± 0.025
		1.0-1.1		
		1.2-1.3		
		1.4-1.5		
		1.6-1.8		
		1.9-2.0		
		2.2-2.5		
		3.0-4.0		
4.2-5.0				

Inserts	Order Code	Grades										
		Carbide				Cermet		Uncoated				
		B100	C200	C250	F20	F30	CE100	CE60	K10		CE	
 <p>8 flutes</p>	3T1629-0.8-ME	☉										
	3T1629-0.9-ME	☉										
	3T1629-1.0-ME	☉										
	3T1629-1.1-ME	☉										
	3T1629-1.2-ME	☉										
	3T1629-1.3-ME	☉										
	3T1629-1.4-ME	☉										
	3T1629-1.5-ME	☉										
	3T1629-1.6-ME	☉										
	3T1629-1.7-ME	☉										
	3T1629-1.8-ME	☉										
	3T1629-1.9-ME	☉										
	3T1629-2.0-ME	☉										
	3T1629-2.2-ME	☉										
	3T1629-2.5-ME	☉										
	3T1629-3.0-ME	☉										
	3T1629-3.5-ME	☉										
	3T1629-4.0-ME	☉										
3T1629-4.2-ME	☉											
3T1629-4.5-ME	☉											
3T1629-5.0-ME	☉											

* M.O.Q: 12PCS
 * Make-to-Order.



- ■ Steel ■ Stainless Steel ☉ Steel/Stainless Steel/Super alloy ■ Cast Iron ■ Aluminum ■ Steel/Cast Iron
- ☉ Steel/Stainless Steel/Cast Iron
- Prices and stocks are based on present conditions
- Please specify model numbers and the grade of inserts, ie.: 3T1629-0.8-ME,B100

UFO T-slot Inserts

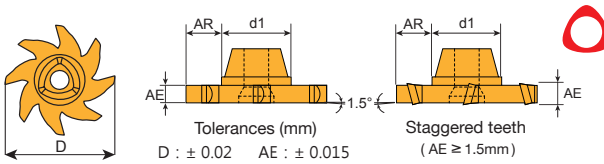
- Toolholders P. 28
- Cutting Data P. 135 - 136



Dimensions (mm)			
D	d1	AE	Max. AR
30	16	0.8-0.9	6.5
		1.0-1.1	
		1.2-1.3	
		1.4-1.5	
		1.6-1.8	
		1.9-2.0	
		2.2-2.5	
		3.0-4.0	
		4.2-5.0	

Inserts	Order Code	Grades									
		Carbide				Cermet		Uncoated			
		B100	C200	C250	F20	F30	CE100	CE60	K10		CE
	3T1630-0.8-E										
	3T1630-0.9-E										
	3T1630-1.0-E										
	3T1630-1.1-E										
	3T1630-1.2-E										
	3T1630-1.3-E										
	3T1630-1.4-E										
	3T1630-1.5-E										
	3T1630-1.6-E										
	3T1630-1.7-E										
	3T1630-1.8-E										
	3T1630-1.9-E										
	3T1630-2.0-E										
	3T1630-2.2-E										
	3T1630-2.5-E										
	3T1630-3.0-E										
	3T1630-3.5-E										
	3T1630-4.0-E										
	3T1630-4.2-E										
	3T1630-4.5-E										
	3T1630-5.0-E										

8 flutes

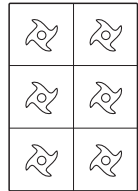

Inserts 6 PCS / Box

- ■ Steel ■ Stainless Steel ■ Steel/Stainless Steel/Super alloy ■ Cast Iron ■ Aluminum ■ Steel/Cast Iron
- ⊗ Steel/Stainless Steel/Cast Iron
- Prices and stocks are based on present conditions
- Please specify model numbers and the grade of inserts, ie.: 3T1630-0.8-E,K10



UFO T-slot Inserts

- Toolholders P. 28
- Cutting Data P. 135 - 136

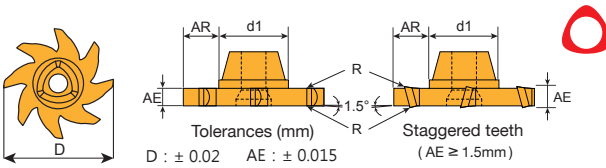

Dimensions (mm)				
D	d1	AE	Max. AR	R
30	16	0.8-0.9	6.5	R0.05 ± 0.025
		1.0-1.1		
		1.2-1.3		
		1.4-1.5		
		1.6-1.8		
		1.9-2.0		
		2.2-2.5		
		3.0-4.0		
4.2-5.0				

Inserts	Order Code	Grades											
		Carbide				Cermet		Uncoated					
		B100	C200	C250	F20	F30	CE100	CE60	K10		CE		
 <p>8 flutes</p>	3T1630-0.8-ME	⊙											
	3T1630-0.9-ME	⊙											
	3T1630-1.0-ME	⊙											
	3T1630-1.1-ME	⊙											
	3T1630-1.2-ME	⊙											
	3T1630-1.3-ME	⊙											
	3T1630-1.4-ME	⊙											
	3T1630-1.5-ME	⊙											
	3T1630-1.6-ME	⊙											
	3T1630-1.7-ME	⊙											
	3T1630-1.8-ME	⊙											
	3T1630-1.9-ME	⊙											
	3T1630-2.0-ME	⊙											
	3T1630-2.2-ME	⊙											
	3T1630-2.5-ME	⊙											
	3T1630-3.0-ME	⊙											
	3T1630-3.5-ME	⊙											
	3T1630-4.0-ME	⊙											
3T1630-4.2-ME	⊙												
3T1630-4.5-ME	⊙												
3T1630-5.0-ME	⊙												

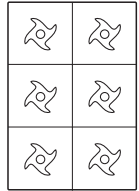

Inserts 6 PCS / Box



- ■ Steel ■ Stainless Steel ⊙ Steel/Stainless Steel/Super alloy ■ Cast Iron ■ Aluminum ■ Steel/Cast Iron
- ⊙ Steel/Stainless Steel/Cast Iron
- Prices and stocks are based on present conditions
- Please specify model numbers and the grade of inserts, ie.: 3T1630-0.8-ME,B100

UFO T-slot Inserts

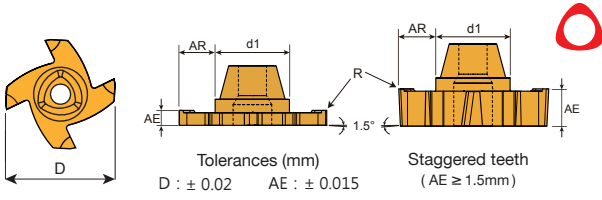
- Toolholders P. 28
- Cutting Data P. 135 - 136



Dimensions (mm)				
D	d1	AE	Max. AR	R
32	16	0.8-0.9	7.5	R0.05 ± 0.025
		1.0-1.1		
		1.2-1.3		
		1.4-1.5		
		1.6-1.8		
		1.9-2.0		
		2.2-2.5		
		3.0-4.0		
		4.2-5.0		
		6.0		
8.0				

Inserts	Order Code	Grades										
		Carbide					Cermet		Uncoated			
		B100	C200	C250	F20	F30	CE100	CE60	K10	CE		
 <p>4 flutes</p>	3T1632C-0.8-ME	⊙										
	3T1632C-0.9-ME	⊙										
	3T1632C-1.0-ME	⊙										
	3T1632C-1.1-ME	⊙										
	3T1632C-1.2-ME	⊙										
	3T1632C-1.3-ME	⊙										
	3T1632C-1.4-ME	⊙										
	3T1632C-1.5-ME	⊙										
	3T1632C-1.6-ME	⊙										
	3T1632C-1.7-ME	⊙										
	3T1632C-1.8-ME	⊙										
	3T1632C-1.9-ME	⊙										
	3T1632C-2.0-ME	⊙										
	3T1632C-2.2-ME	⊙										
	3T1632C-2.5-ME	⊙										
	3T1632C-3.0-ME	⊙										
	3T1632C-3.5-ME	⊙										
	3T1632C-4.0-ME	⊙										
3T1632C-4.2-ME	⊙											
3T1632C-4.5-ME	⊙											
3T1632C-5.0-ME	⊙											
3T1632C-6.0-ME	⊙											
3T1632C-8.0-ME	⊙											



Inserts 6 PCS / Box

* M.O.Q: 12PCS
* Make-to-Order.

- ⊙ Steel / Stainless Steel / Super alloy / Cast Iron
- Prices and stocks are based on present conditions
- Please specify model numbers and the grade of inserts, ie.: 3T1632C-0.8-ME, B100



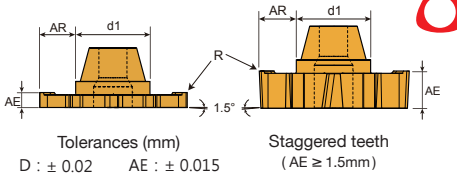
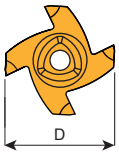

UFO T-slot Inserts

- Toolholders P. 28
- Cutting Data P. 135 - 136



Dimensions (mm)				
D	d1	AE	Max. AR	R
35	16	0.8-0.9	9	R0.05 ± 0.025
		1.0-1.1		
		1.2-1.3		
		1.4-1.5		
		1.6-1.8		
		1.9-2.0		
		2.2-2.5		
		3.0-4.0		
		4.2-5.0		
		6.0		
8.0				

Inserts	Order Code	Grades									
		Carbide					Cermet		Uncoated		
		B100	C200	C250	F20	F30	CE100	CE60	K10		CE
 4 flutes	3T1635C-0.8-ME	☉									
	3T1635C-0.9-ME	☉									
	3T1635C-1.0-ME	☉									
	3T1635C-1.1-ME	☉									
	3T1635C-1.2-ME	☉									
	3T1635C-1.3-ME	☉									
	3T1635C-1.4-ME	☉									
	3T1635C-1.5-ME	☉									
	3T1635C-1.6-ME	☉									
	3T1635C-1.7-ME	☉									
	3T1635C-1.8-ME	☉									
	3T1635C-1.9-ME	☉									
	3T1635C-2.0-ME	☉									
	3T1635C-2.2-ME	☉									
	3T1635C-2.5-ME	☉									
	3T1635C-3.0-ME	☉									
	3T1635C-3.5-ME	☉									
	3T1635C-4.0-ME	☉									
3T1635C-4.2-ME	☉										
3T1635C-4.5-ME	☉										
3T1635C-5.0-ME	☉										
3T1635C-6.0-ME	☉										
3T1635C-8.0-ME	☉										

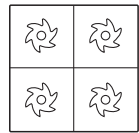

Inserts 4 PCS / Box

- ☉ Steel / Stainless Steel / Super alloy / Cast Iron
- Prices and stocks are based on present conditions
- Please specify model numbers and the grade of inserts, ie.: 3T1635C-0.8-ME, B100

UFO T-slot Inserts

- Toolholders P. 28
- Cutting Data P. 135 - 136

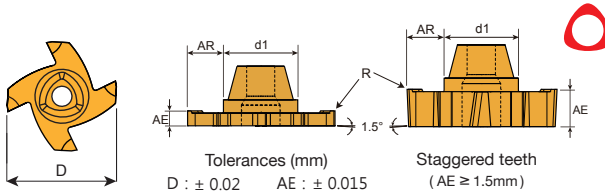

Dimensions (mm)				
D	d1	AE	Max. AR	R
37	16	0.8-0.9	10	R0.05 \pm 0.025
		1.0-1.1		
		1.2-1.3		
		1.4-1.5		
		1.6-1.8		
		1.9-2.0		
		2.2-2.5		
		3.0-4.0		
		4.2-5.0		
		6.0		
8.0				

UFO Family

Inserts	Order Code	Grades									
		Carbide				Cermet		Uncoated			
		B100	C200	C250	F20	F30	CE100	CE60	K10		CE
	3T1637C-0.8-ME	⊙									
	3T1637C-0.9-ME	⊙									
	3T1637C-1.0-ME	⊙									
	3T1637C-1.1-ME	⊙									
	3T1637C-1.2-ME	⊙									
	3T1637C-1.3-ME	⊙									
	3T1637C-1.4-ME	⊙									
	3T1637C-1.5-ME	⊙									
	3T1637C-1.6-ME	⊙									
	3T1637C-1.7-ME	⊙									
	3T1637C-1.8-ME	⊙									
	3T1637C-1.9-ME	⊙									
	3T1637C-2.0-ME	⊙									
	3T1637C-2.2-ME	⊙									
	3T1637C-2.5-ME	⊙									
	3T1637C-3.0-ME	⊙									
	3T1637C-3.5-ME	⊙									
	3T1637C-4.0-ME	⊙									
	3T1637C-4.2-ME	⊙									
	3T1637C-4.5-ME	⊙									
	3T1637C-5.0-ME	⊙									
	3T1637C-6.0-ME	⊙									
	3T1637C-8.0-ME	⊙									

Inserts 4 PCS / Box

* M.O.Q: 8PCS
* Make-to-Order.

- ⊙ Steel / Stainless Steel / Super alloy / Cast Iron
- Prices and stocks are based on present conditions
- Please specify model numbers and the grade of inserts, ie.: 3T1637C-0.8-ME, B100



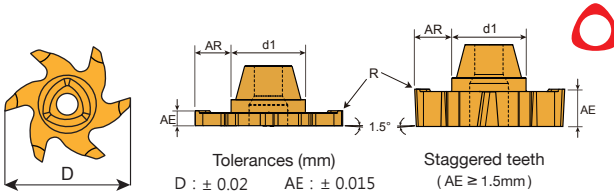

UFO T-slot Inserts

- Toolholders P. 28
- Cutting Data P. 135 - 136

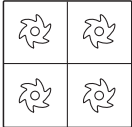

Dimensions (mm)			
D	d1	AE	Max. AR
35	16	0.8-0.9	9
		1.0-1.1	
		1.2-1.3	
		1.4-1.5	
		1.6-1.8	
		1.9-2.0	
		2.2-2.5	
		3.0-4.0	
		4.2-5.0	
		6.0	
8.0			

Inserts	Order Code	Grades										
		Carbide				Cermet		Uncoated				
		B100	C200	C250	F20	F30	CE100	CE60	K10		CE	
 <p>6 flutes</p>	3T1635-0.8-E											 <p>Inserts 4 PCS / Box</p>
	3T1635-0.9-E											
	3T1635-1.0-E											
	3T1635-1.1-E											
	3T1635-1.2-E											
	3T1635-1.3-E											
	3T1635-1.4-E											
	3T1635-1.5-E											
	3T1635-1.6-E											
	3T1635-1.7-E											
	3T1635-1.8-E											
	3T1635-1.9-E											
	3T1635-2.0-E											
	3T1635-2.2-E											
	3T1635-2.5-E											
	3T1635-3.0-E											
	3T1635-3.5-E											
	3T1635-4.0-E											
3T1635-4.2-E												
3T1635-4.5-E												
3T1635-5.0-E												
3T1635-6.0-E												
3T1635-8.0-E												

-  Aluminum
- Prices and stocks are based on present conditions
- Please specify model numbers and the grade of inserts, ie.: 3T1635-0.8-E, K10

UFO T-slot Inserts

- Toolholders P. 28
- Cutting Data P. 135 - 136

UFO Family

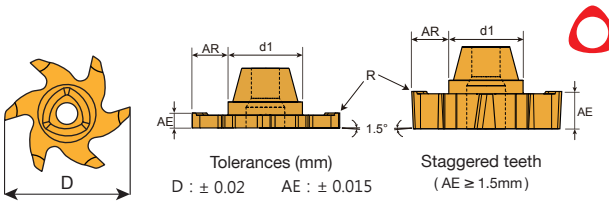

Dimensions (mm)				
D	d1	AE	Max. AR	R
35	16	0.8-0.9	9	R0.05 \pm 0.025
		1.0-1.1		
		1.2-1.3		
		1.4-1.5		
		1.6-1.8		
		1.9-2.0		
		2.2-2.5		
		3.0-4.0		
		4.2-5.0		
		6.0		
8.0				

Inserts	Order Code	Grades									
		Carbide				Cermet		Uncoated			
		B100	C200	C250	F20	F30	CE100	CE60	K10		CE
	3T1635-0.8-ME	⊙									
	3T1635-0.9-ME	⊙									
	3T1635-1.0-ME	⊙									
	3T1635-1.1-ME	⊙									
	3T1635-1.2-ME	⊙									
	3T1635-1.3-ME	⊙									
	3T1635-1.4-ME	⊙									
	3T1635-1.5-ME	⊙									
	3T1635-1.6-ME	⊙									
	3T1635-1.7-ME	⊙									
	3T1635-1.8-ME	⊙									
	3T1635-1.9-ME	⊙									
	3T1635-2.0-ME	⊙									
	3T1635-2.2-ME	⊙									
	3T1635-2.5-ME	⊙									
	3T1635-3.0-ME	⊙									
	3T1635-3.5-ME	⊙									
	3T1635-4.0-ME	⊙									
	3T1635-4.2-ME	⊙									
	3T1635-4.5-ME	⊙									
	3T1635-5.0-ME	⊙									
	3T1635-6.0-ME	⊙									
	3T1635-8.0-ME	⊙									

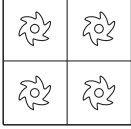

Inserts 4 PCS / Box

* M.O.Q: 8PCS
* Make-to-Order.

- ⊙ Steel / Stainless Steel / Super alloy / Cast Iron
- Prices and stocks are based on present conditions
- Please specify model numbers and the grade of inserts, ie.: 3T1635-0.8-ME, B100



UFO T-slot Inserts

- Toolholders P. 28
- Cutting Data P. 135 - 136

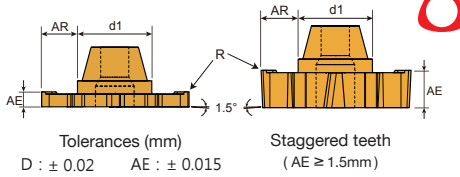
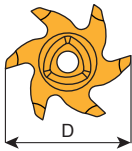

Dimensions (mm)			
D	d1	AE	Max. AR
37	16	0.8-0.9	10
		1.0-1.1	
		1.2-1.3	
		1.4-1.5	
		1.6-1.8	
		1.9-2.0	
		2.2-2.5	
		3.0-4.0	
		4.2-5.0	
		6.0	
8.0			

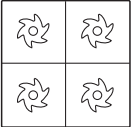
Inserts	Order Code	Grades										
		Carbide				Cermet		Uncoated				
		B100	C200	C250	F20	F30	CE100	CE60	K10		CE	
 <p>6 flutes</p>	3T1637-0.8-E											 <p>Inserts 4 PCS / Box</p>
	3T1637-0.9-E											
	3T1637-1.0-E											
	3T1637-1.1-E											
	3T1637-1.2-E											
	3T1637-1.3-E											
	3T1637-1.4-E											
	3T1637-1.5-E											
	3T1637-1.6-E											
	3T1637-1.7-E											
	3T1637-1.8-E											
	3T1637-1.9-E											
	3T1637-2.0-E											
	3T1637-2.2-E											
	3T1637-2.5-E											
	3T1637-3.0-E											
	3T1637-3.5-E											
	3T1637-4.0-E											
3T1637-4.2-E												
3T1637-4.5-E												
3T1637-5.0-E												
3T1637-6.0-E												
3T1637-8.0-E												

-  Aluminum
- Prices and stocks are based on present conditions
- Please specify model numbers and the grade of inserts, ie.: 3T1637-0.8-E, K10

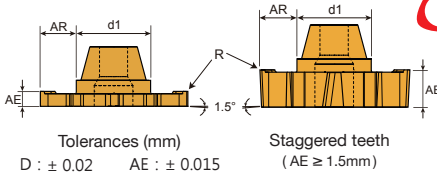
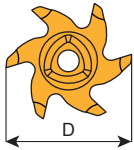

UFO T-slot Inserts

- Toolholders P. 28
- Cutting Data P. 135 - 136



Dimensions (mm)				
D	d1	AE	Max. AR	R
37	16	0.8-0.9	10	R0.05 ± 0.025
		1.0-1.1		
		1.2-1.3		
		1.4-1.5		
		1.6-1.8		
		1.9-2.0		
		2.2-2.5		
		3.0-4.0		
		4.2-5.0		
		6.0		
8.0				

UFO Family

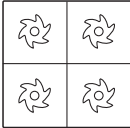
Inserts	Order Code	Grades									
		Carbide					Cermet		Uncoated		
		B100	C200	C250	F20	F30	CE100	CE60	K10		CE
 <p>6 flutes</p>	3T1637-0.8-ME	☉									 <p>Inserts 4 PCS / Box</p> <p>* M.O.Q: 8PCS * Make-to-Order.</p>
	3T1637-0.9-ME	☉									
	3T1637-1.0-ME	☉									
	3T1637-1.1-ME	☉									
	3T1637-1.2-ME	☉									
	3T1637-1.3-ME	☉									
	3T1637-1.4-ME	☉									
	3T1637-1.5-ME	☉									
	3T1637-1.6-ME	☉									
	3T1637-1.7-ME	☉									
	3T1637-1.8-ME	☉									
	3T1637-1.9-ME	☉									
	3T1637-2.0-ME	☉									
	3T1637-2.2-ME	☉									
	3T1637-2.5-ME	☉									
	3T1637-3.0-ME	☉									
	3T1637-3.5-ME	☉									
	3T1637-4.0-ME	☉									
3T1637-4.2-ME	☉										
3T1637-4.5-ME	☉										
3T1637-5.0-ME	☉										
3T1637-6.0-ME	☉										
3T1637-8.0-ME	☉										

- ☉ Steel / Stainless Steel / Super alloy / Cast Iron
- Prices and stocks are based on present conditions
- Please specify model numbers and the grade of inserts, ie.: 3T1637-0.8-ME, B100



UFO T-SLOT - CN / N SERIES

Exclusively for Collet Machining



Exclusively for Collet Machining - CN / N

Y.T.'s groundbreaking collet machining advantages

New UFO-T-slot cutter
CN / N series
(4 flutes · 6 flutes)



Traditional / slitting saw



UFO Family

The latest collet-exclusive UFO T-slot cutter features an unique cutting edge design, effectively reducing machining resistance and achieving cutting speeds up to 10 times faster than traditional slitting saw.

The UFO taper polygon positioning design ensures more precise locking mechanism, with no interference at the bottom of the tool.

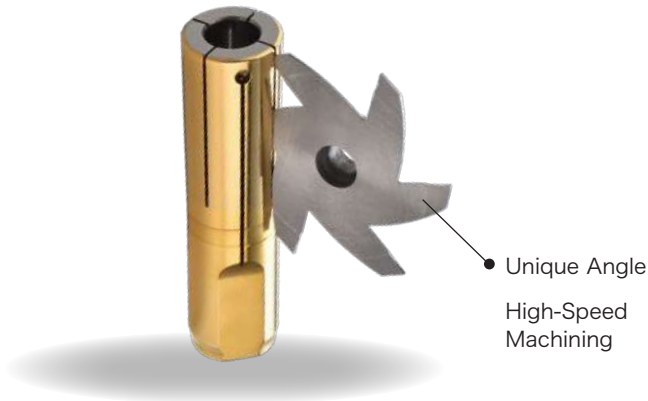

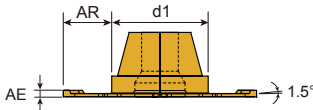
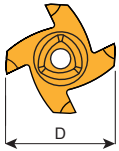

UFO T-slot Inserts- CN

- Toolholders P. 28
- Cutting Data P. 135 - 136

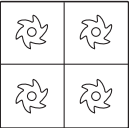

Dimensions (mm)				
D	d1	AE	Max. AR	R
35	16	0.6	9	R0.05 ± 0.025
		0.8		
		1.0		
		1.2		
		1.4		
		1.6		
		1.8		
2.0				

Inserts	Order Code	Grades									
		Carbide					Cermet		Uncoated		
		B100	C200	C250	F20	F30	CE100	CE60	K10		CE
 <p>4 flutes</p>	3T1635CN-0.6-ME	☉									 <p>Inserts 4 PCS / Box</p>
	3T1635CN-0.8-ME	☉									
	3T1635CN-1.0-ME	☉									
	3T1635CN-1.2-ME	☉									
	3T1635CN-1.4-ME	☉									
	3T1635CN-1.6-ME	☉									
	3T1635CN-1.8-ME	☉									
	3T1635CN-2.0-ME	☉									



- ☉ Steel / Stainless Steel / Super alloy / Cast Iron
- Prices and stocks are based on present conditions
- Please specify model numbers and the grade of inserts, ie.: 3T1635CN-0.6-ME, B100

UFO T-slot Inserts- CN

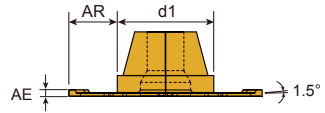
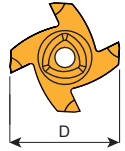
- Toolholders P. 28
- Cutting Data P. 135 - 136

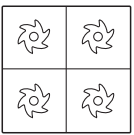

Dimensions (mm)				
D	d1	AE	Max. AR	R
37	16	0.6	10	R0.05 ± 0.025
		0.8		
		1.0		
		1.2		
		1.4		
		1.6		
		1.8		
	2.0			

Inserts	Order Code	Grades									
		Carbide					Cermet		Uncoated		
		B100	C200	C250	F20	F30	CE100	CE60	K10		CE
 <p>4 flutes</p>	3T1637CN-0.6-ME	⊙									 <p>Inserts 4 PCS / Box</p>
	3T1637CN-0.8-ME	⊙									
	3T1637CN-1.0-ME	⊙									
	3T1637CN-1.2-ME	⊙									
	3T1637CN-1.4-ME	⊙									
	3T1637CN-1.6-ME	⊙									
	3T1637CN-1.8-ME	⊙									
	3T1637CN-2.0-ME	⊙									

- ⊙ Steel / Stainless Steel / Super alloy / Cast Iron
- Prices and stocks are based on present conditions
- Please specify model numbers and the grade of inserts, ie.: 3T1637CN-0.6-ME, B100



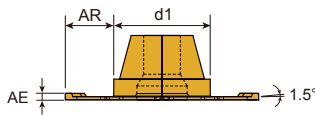
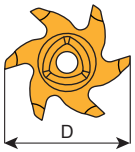

UFO T-slot Inserts - N

- Toolholders P. 28
- Cutting Data P. 135 - 136

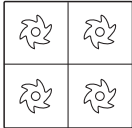

Dimensions (mm)				
D	d1	AE	Max. AR	R
35	16	0.6	9	R0.05 ± 0.025
		0.8		
		1.0		
		1.2		
		1.4		
		1.6		
		1.8		
2.0				

Inserts	Order Code	Grades									
		Carbide				Cermet		Uncoated			
		B100	C200	C250	F20	F30	CE100	CE60	K10		CE
 6 flutes	3T1635N-0.6-ME	☉									 Inserts 4 PCS / Box
	3T1635N-0.8-ME	☉									
	3T1635N-1.0-ME	☉									
	3T1635N-1.2-ME	☉									
	3T1635N-1.4-ME	☉									
	3T1635N-1.6-ME	☉									
	3T1635N-1.8-ME	☉									
	3T1635N-2.0-ME	☉									



- ☉ Steel / Stainless Steel / Super alloy / Cast Iron
- Prices and stocks are based on present conditions
- Please specify model numbers and the grade of inserts, ie.: 3T1635N-0.6-ME, B100

UFO T-slot Inserts - N

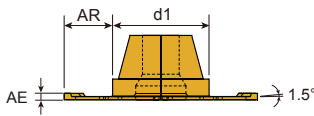
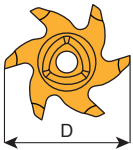
- Toolholders P. 28
- Cutting Data P. 135 - 136

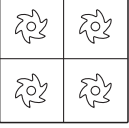

Dimensions (mm)				
D	d1	AE	Max. AR	R
37	16	0.6	10	R0.05 ± 0.025
		0.8		
		1.0		
		1.2		
		1.4		
		1.6		
		1.8		
2.0				

Inserts	Order Code	Grades									
		Carbide				Cermet		Uncoated			
		B100	C200	C250	F20	F30	CE100	CE60	K10		CE
 <p>6 flutes</p>	3T1637N-0.6-ME	☉									 <p>Inserts 4 PCS / Box</p>
	3T1637N-0.8-ME	☉									
	3T1637N-1.0-ME	☉									
	3T1637N-1.2-ME	☉									
	3T1637N-1.4-ME	☉									
	3T1637N-1.6-ME	☉									
	3T1637N-1.8-ME	☉									
	3T1637N-2.0-ME	☉									

- ☉ Steel / Stainless Steel / Super alloy / Cast Iron
- Prices and stocks are based on present conditions
- Please specify model numbers and the grade of inserts, ie.: 3T1637N-0.6-ME, B100



UFO T-SLOT CUTTER

PATENTED



 Patent No. : M538848

 Patent No. : ZL 2016 2 1300067.8

 PCT Priority

Features

Available in materials

P K M
N S H

Cost
200~300%
SAVING

Applicable
Machines
CNC Milling machine

Efficiency
400%
UP

Durability
300%
UP

UFO T-slot Cutters

- Toolholders P. 28
- Inserts P. 235 - 242
- Cutting Data P. 137 - 138

3T

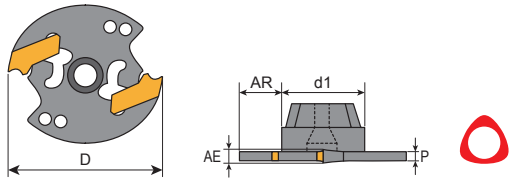

Order Code	Dimensions (mm)					Z	KG	MAX RPM	Inserts LNGT	Wrench
	D	d1	AR	AE	P					
3T1632-1.4	32	16	7.5	1.4	1.2	2	0.03	8000	1414	150.10-30
3T1632-1.6				1.5					1415	
3T1632-1.8				1.6	1616					
3T1632-2.0				1.8	1818					
3T1632-2.5				2.0	1.7					
				2.2						
				2.5						
3T1632-3.0				2.5	2.25					
				2.7						
				3.0						
3T1632-4.0	3.0	2.7								
	3.2									
	3.5									
3T1632-5.0	4.0	3.7								
	4.2									
	4.5									
3T1632-5.0	5.0	4.5								
	5.2									
	5.5									

* Wrench 150.10-30 for above cutter order seperately.



UFO T-slot Cutters

- Toolholders P. 28
- Inserts P. 235 - 242
- Cutting Data P. 137 - 138

3T

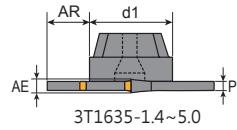
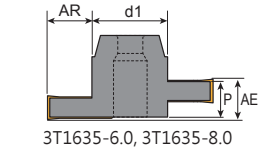
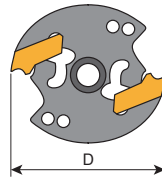

Order Code	Dimensions (mm)					Z	ZC	KG	MAX RPM	Inserts LNGT	Wrench		
	D	d1	AR	AE	P								
3T1635-1.4	35	16	9.0	1.4	1.2	2	2	8000	1414 1415	150.10-30			
3T1635-1.6				1.6									
3T1635-1.8				1.8	1.6						0.03	1818	
3T1635-2.0				2.0 2.2 2.5									
3T1635-2.5				2.5 2.7 3.0	2.25						2	2525 2527 2530	
3T1635-3.0				3.0 3.2 3.5									
3T1635-4.0				4.0 4.2 4.5	3.7						0.04	4040 4042 4045	
3T1635-5.0				5.0 5.2 5.5									
3T1635-6.0				6.0	5.5						1	0.05	5050NS
3T1635-8.0				8.0									

* Wrench 150.10-30 for above cutter order seperately.

UFO T-slot Cutters

- Toolholders P. 28
- Inserts P. 235 - 242
- Cutting Data P. 137 - 138

3T

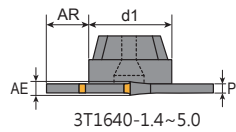
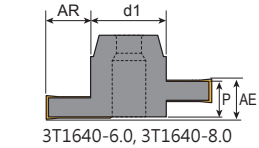
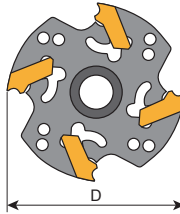

Order Code	Dimensions (mm)					Z	ZC	Ⓚ KG	MAX RPM	Inserts LNGT	Wrench
	D	d1	AR	AE	P						
3T1640-1.4	40	16	11.5	1.4	1.2	4	-	0.03	7500	1414	150.10-30
3T1640-1.6				1.5						1415	
3T1640-1.8				1.6						1616	
3T1640-2.0				1.8	1818						
3T1640-2.5				2.0	2.25					2020	
				2.2						2022	
				2.5						2025	
3T1640-3.0				2.5	2.7					2525	
				2.7						2527	
				3.0						2530	
3T1640-4.0	3.0	2.7	3030								
	3.2		3032								
	3.5		3035								
3T1640-5.0	4.0	3.7	4040								
	4.2		4042								
	4.5		4045								
3T1640-5.0	5.0	4.5	5050								
	5.2		5052								
	5.5		5055								
3T1640-6.0	2	0.06	6.0	5.5	5050NS						
3T1640-8.0			8.0	7.5							

* Wrench 150.10-30 for above cutter order seperately.



UFO T-slot Cutters

- Toolholders P. 29
- Inserts P. 235 - 242
- Cutting Data P. 137 - 138

3T

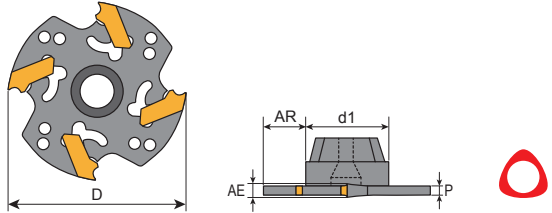

Order Code	Dimensions (mm)					Z	KG	MAX RPM	Inserts LNGT	Wrench					
	D	d1	AR	AE	P										
3T2550-1.4	50	25	12	1.4	1.2	4	7000	1414 1415	150.10-30						
3T2550-1.6				1.6											
3T2550-1.8				1.8											
3T2550-2.0				2.0 2.2 2.5	1.7										
3T2550-2.5				2.5 2.7 3.0						2.25					
3T2550-3.0				3.0 3.2 3.5	2.7										
3T2550-4.0				4.0 4.2 4.5						3.7					
3T2550-5.0				5.0 5.2 5.5	4.5										
														0.07	
													0.08		
						0.08									
						0.08									
						0.09									
						0.09									
						0.10									
						0.10									

* Wrench 150.10-30 for above cutter order seperately.

UFO T-slot Cutters

- Toolholders P. 29
- Inserts P. 235 - 242
- Cutting Data P. 137 - 138

3T

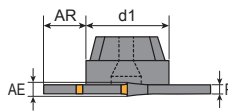
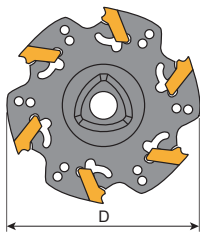

Order Code	Dimensions (mm)					Z	KG	MAX RPM	Inserts LNGT	Wrench
	D	d1	AR	AE	P					
3T2560-1.4	60	25	17	1.4	1.2	6	0.09	6500	1414	150.10-30
3T2560-1.6				1.5					1415	
3T2560-1.8				1.6	1616					
3T2560-2.0				1.8	1818					
3T2560-2.5				2.0	2.25					
				2.2						
				2.5						
3T2560-3.0				2.5	2.7					
				2.7						
				3.0						
3T2560-4.0	3.0	2.7								
	3.2									
	3.5									
3T2560-5.0	4.0	3.7								
	4.2									
	4.5									
3T2560-5.0	5.0	4.5								
	5.2									
	5.5									

* Wrench 150.10-30 for above cutter order seperately.



UFO T-slot Cutters

- Toolholders P. 29
- Inserts P. 235 - 242
- Cutting Data P. 137 - 138

3T

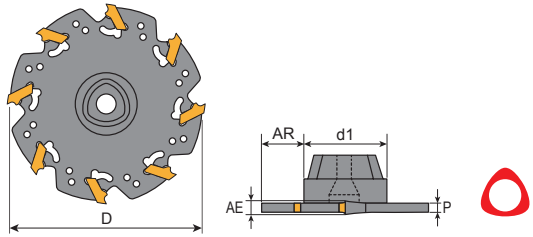

Order Code	Dimensions (mm)					Z	KG	MAX RPM	Inserts LNGT	Wrench
	D	d1	AR	AE	P					
3T2580-1.4	80	25	27	1.4	1.2	8	0.11	6500	1414	150.10-30
3T2580-1.6				1.5					1415	
3T2580-1.8				1.6	1616					
3T2580-2.0				1.8	1818					
3T2580-2.5				2.0	2.25					
				2.2						
				2.5						
3T2580-3.0				2.5	2.7					
				2.7						
				3.0						
3T2580-4.0	3.0	2.7								
	3.2									
	3.5									
3T2580-5.0	4.0	3.7								
	4.2									
	4.5									
3T2580-5.0	5.0	4.5								
	5.2									
	5.5									

* Wrench 150.10-30 for above cutter order seperately.

UFO T-slot Cutters

- Toolholders P. 29
- Inserts P. 242 - 244
- Cutting Data P. 139 - 140

3TS

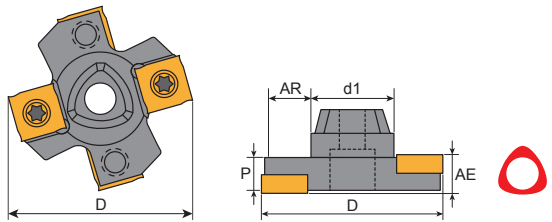

Order Code	Dimensions (mm)					Z	Zc	KG	MAX RPM	Inserts SNGX SNGW	Screw	Key
	D	d1	AR	AE	P							
3TS2550-4.0	50	25	12	4	3.4	4	2	0.09	17000	1102	T9354	908-T9
3TS2550-5.0				5	4.2					1103	T9355	908-T8
3TS2550-6.0				6	5					1203	T945	908-T15
3TS2550-7.0				7	6					1204	T946	
3TS2550-8.0				8	7					12045	T947	
3TS2550-10				10	9					1205	T948	
3TS2550-12				12	11					1207	T9411	

* Fit Insert SNGW...R2.5 and R3.0, cutter have to modified (ask salesman).



UFO T-slot Cutters

- Toolholders P. 29
- Inserts P. 242 - 244
- Cutting Data P. 139 - 140

3TS

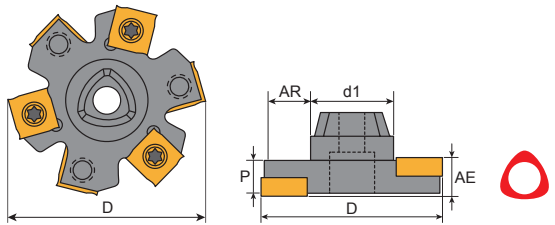

Order Code	Dimensions (mm)					Z	Zc	 KG	MAX RPM	Inserts SNGX SNGW	Screw	Key
	D	d1	AR	AE	P							
3TS2560-4.0	60	25	17	4	3.4	6	3	0.10	15000	1102	T9354	908-T9
3TS2560-5.0				5	4.2					1103	T9355	908-T8
3TS2560-6.0				6	5					1203	T945	908-T15
3TS2560-7.0				7	6			0.12		1204	T946	
3TS2560-8.0				8	7			12045		T947		
3TS2560-10				10	9			0.17		1205	T948	
3TS2560-12				12	11			0.18		1207	T9411	

* Fit Insert SNGW...R2.5 and R3.0, cutter have to modified (ask salesman).

UFO T-slot Cutters

- Toolholders P. 29
- Inserts P. 242 - 244
- Cutting Data P. 139 - 140

3TS

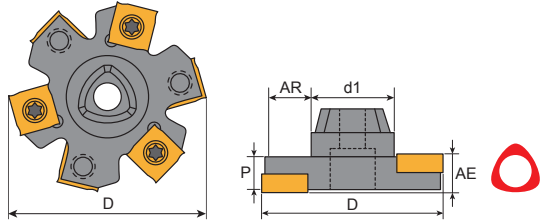

Order Code	Dimensions (mm)					Z	Zc	KG	MAX RPM	Inserts SNGX SNGW	Screw	Key
	D	d1	AR	AE	P							
3TS2580-4.0	80	25	27	4	3.4	8	4	0.13	14000	1102	T9354	908-T9
3TS2580-5.0				5	4.2					1103	T9355	908-T8
3TS2580-6.0				6	5					1203	T945	908-T15
3TS2580-7.0				7	6					0.21	1204	
3TS2580-8.0				8	7	12045	T947					
3TS2580-10				10	9	6	3			0.31	1205	T948
3TS2580-12				12	11	0.31	1207			T9411		

* Fit Insert SNGW...R2.5 and R3.0,cutter have to modified (ask salesman).



UFO T-slot Cutters

• Toolholders P. 29

3T

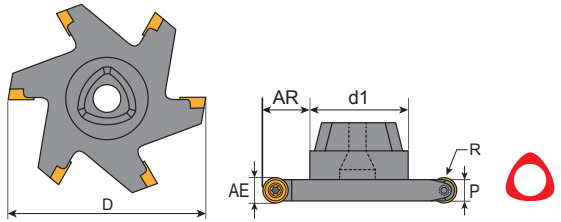

Order Code	Dimensions (mm)						Z	KG	MAX RPM	Inserts RDKW RDKT RPKT	Screw	Key	
	D	d1	AR	AE	P	R							
3T2560-R4	60	25	17	8	6.2	4R	6	0.20	13000	0803	C02506	T08P	
3T2580-R4	80		27										
3T2560-R5	60		17	10	8.0	5R		4	0.30	13000	10T3	C03007	T09P
3T2580-R5	80		27										
3T2560-R6	60		17	12	10	6R		4	0.40	9500	1204	C03508 -T15	T15P
3T2580-R6	80		27										

RDKT / RDKW / RPKT Inserts

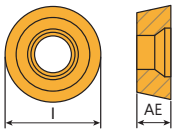

Tolerances (mm)
D=±0.04 AE=±0.05

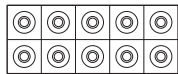

Inserts 10 PCS / Box

Dimensions (mm)			
Code	AE	I	R
0803	3.05	8	4
10T3	3.97	10	5
1204	4.7	12	6

Inserts	Order Code	Grades								
		Carbide					Metal cermet		Uncoated	
		B100	C200	C250	F20	F30	CE25	CE60	K10	CE
	RDKW 0803MOT-MD	⊙								
	RDKT 10T3MOT-M	⊙								
	RPKT 1204MOT-M	⊙								

- Steel Stainless Steel Steel/Stainless Steel/Super alloy Cast Iron Aluminum Steel/Cast Iron
- Steel/Stainless Steel/Cast Iron
- Prices and stocks are based on present conditions
- Please specify model numbers and the grade of inserts, ie.: RDKW 0803MOT-MD, B100

**UFO
RADIUS
DUAL CORNER ROUNDING
CONCAVE RADIUS
DUAL CHAMFER
DOVETAIL
CIRCLIP**



Video

PATENTED

Features

Available in
materials



Cost
200~300%
SAVING

Applicable
Machines
CNC Milling machine

Efficiency
400%
UP

Durability
300%
UP





UFO



UFO Radius Inserts

R0.5 to R3.0 cutters are readily available in stock. Performs impressive cutting speed in 6 flutes.

Fig.1

UFO Dovetail Inserts

Available with 45°, 60° angles and designed with 6 flutes.

UFO Dual Chamfer

Up and down chamfering are available in the same insert.

Support different angles and radii:

- 45° chamfer: Ø9.8-Ø11.8-Ø14.8 with 4 teeth.
- Radius: R0.5~R2.0, Ø9.8-Ø11.8-Ø19.8 with 4 teeth.

Fig.2/3/4

UFO Circlip Inserts

For circlip range: 1.1~4.15 mm
Same shank fits all different inserts. All items are available from stock.

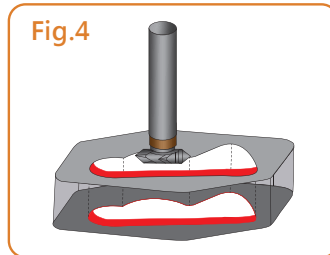
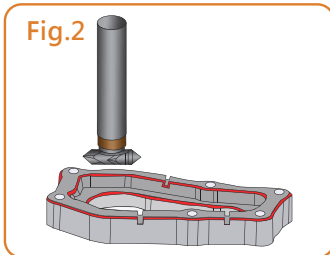
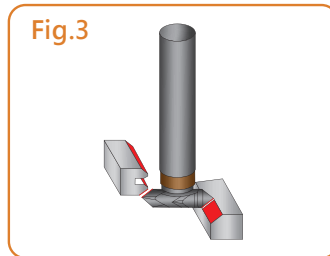
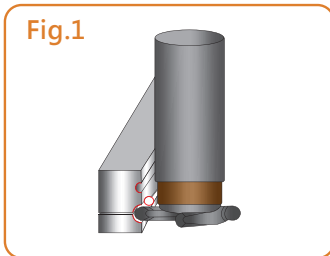

UFO Radius Inserts

- Toolholders P. 26
- Cutting Data P. 135 - 136

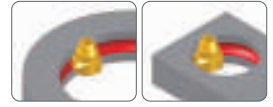

UFO Family

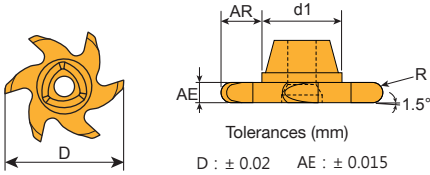

Dimensions (mm)				
D	d1	AE	R	Max. AR
20	9.9	1.0	0.5	4.5
		1.5	0.75	
		2.0	1.0	
		2.5	1.25	
		3.0	1.5	
		4.0	2.0	
		5.0	2.5	
		6.0	3.0	

Inserts	Order Code	Grades										
		Carbide					Metal cermet		Uncoated			
		B100	C200	C250	F20	F30	CE25	CE60	K10	CE		
<p>6 flutes</p>	3T1020-R0.5-E											
	3T1020-R0.75-E											
	3T1020-R1.0-E											
	3T1020-R1.25-E											
	3T1020-R1.5-E											
	3T1020-R2.0-E											
	3T1020-R2.5-E											
	3T1020-R3.0-E											
	3T1020-R0.5-ME		⊙									
	3T1020-R0.75-ME		⊙									
	3T1020-R1.0-ME		⊙									
	3T1020-R1.25-ME		⊙									
	3T1020-R1.5-ME		⊙									
	3T1020-R2.0-ME		⊙									
	3T1020-R2.5-ME		⊙									
3T1020-R3.0-ME		⊙										

Inserts 6 PCS / Box

- ■ Steel ■ Stainless Steel ⊙ Steel/Stainless Steel/Super alloy ■ Cast Iron ■ Aluminum ■ Steel/Cast Iron
- ⊙ Steel/Stainless Steel/Cast Iron
- Prices and stocks are based on present conditions
- Please specify model numbers and the grade of inserts, ie.: 3T1020-R0.5-E, F20







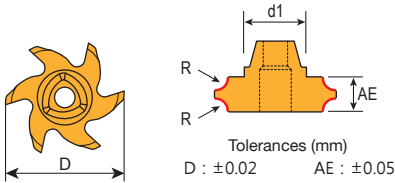
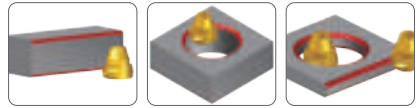



UFO Dual Corner Rounding Inserts

- Toolholders P. 24 · P. 26
- Cutting Data P. 135 - 136



Dimensions (mm)				
D	d1	AE	R	Max. AR
9.8	6.5	3.0	0.5	0.5
		3.0	0.5	0.5
4.0		1.0	1.0	
5.0		1.5	1.5	
19.8		3.0	0.5	0.5
	3.5	0.75	0.75	
	4.0	1.0	1.0	
	4.5	1.25	1.25	
	5.0	1.5	1.5	
	6.0	2.0	2.0	

Inserts	Order Code	Grades												
		Carbide					Metal cermet		Uncoated					
		B100	C200	C250	F20	F30	CE25	CE60	K10	CE				
 4 flutes dia 10-12	3T0610-DCR0.5-E													     
	3T0612-DCR0.5-E													
	3T0612-DCR1.0-E													
	3T0612-DCR1.5-E													
	3T1020-DCR0.5-E													
	3T1020-DCR0.75-E													
	3T1020-DCR1.0-E													
	3T1020-DCR1.25-E													
	3T1020-DCR1.5-E													
	3T1020-DCR2.0-E													
 6 flutes dia 20	3T0610-DCR0.5-ME	⊙												
	3T0612-DCR0.5-ME	⊙												
	3T0612-DCR1.0-ME	⊙												
	3T0612-DCR1.5-ME	⊙												
	3T1020-DCR0.5-ME	⊙												
	3T1020-DCR0.75-ME	⊙												
	3T1020-DCR1.0-ME	⊙												
	3T1020-DCR1.25-ME	⊙												
	3T1020-DCR1.5-ME	⊙												
	3T1020-DCR2.0-ME	⊙												

Inserts 6 PCS / Box

- ■ Steel ■ Stainless Steel ⊙ Steel/Stainless Steel/Super alloy ■ Cast Iron ■ Aluminum ■ Steel/Cast Iron
- ⊙ Steel/Stainless Steel/Cast Iron
- Prices and stocks are based on present conditions
- Please specify model numbers and the grade of inserts, ie.: 3T0610-DCR0.5-E,F20

UFO Dual Chamfer Inserts

- Toolholders P. 24 - 25
- Cutting Data P. 135 - 136

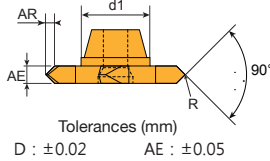
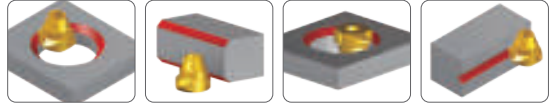

Dimensions (mm)					
D	d1	AE	Max. AR	R	
9.8	6.5	3	0.5	0.2	
11.8			1.0		
14.8			7.9		

Inserts	Order Code	Grades										
		Carbide					Metal cermet		Uncoated			
		B100	C200	C250	F20	F30	CE25	CE60	K10	CE		
 4 flutes	3T0610-3-45-E											
	3T0612-3-45-E											
	3T0815-3-45-E											
	3T0610-3-45-ME	⊙										
	3T0612-3-45-ME	⊙										
	3T0815-3-45-ME	⊙										

Inserts 6 PCS / Box

UFO Dovetail Inserts

- Toolholders P. 26
- Cutting Data P. 135 - 136

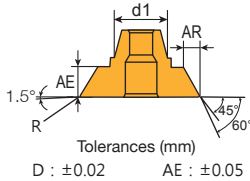
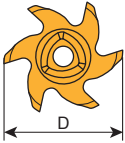
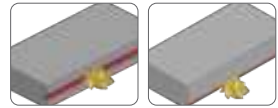

Dimensions (mm)					
D	d1	AE	Angle	Max. AR	R
20	9.9	5.0	45°	3.0	0.4
			60°	2.5	

Inserts	Order Code	Grades									
		Carbide					Metal cermet		Uncoated		
		B100	C200	C250	F20	F30	CE25	CE60	K10	CE	
 6 flutes	3T1020-45-E										
	3T1020-60-E										
	3T1020-45-ME	⊙									
	3T1020-60-ME	⊙									

Inserts 6 PCS / Box

- ■ Steel ■ Stainless Steel ⊙ Steel/Stainless Steel/Super alloy ■ Cast Iron ■ Aluminum ■ Steel/Cast Iron
- ⊙ Steel/Stainless Steel/Cast Iron
- Prices and stocks are based on present conditions
- Please specify model numbers and the grade of inserts, ie.: 3T1020-45-E,F20



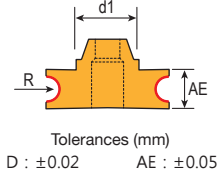
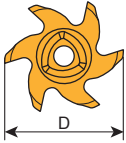

UFO Concave Radius Inserts

- Toolholders P. 26
- Cutting Data P. 135 - 136

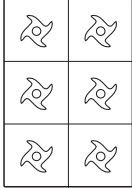

Dimensions (mm)			
D	d1	AE	R
20	10	4.5	1.0
		5.0	1.25
		5.5	1.5
		6.5	2.0

Inserts	Order Code	Grades												
		Carbide					Metal cermet	Uncoated						
		B100	C200	C250	F20	F30	CE25	CE60	K10		CE			
 <p>6 flutes</p>	3T1020-CR1.0-E												 <p>Inserts 6 PCS / Box</p>	
	3T1020-CR1.25-E													
	3T1020-CR1.5-E													
	3T1020-CR2.0-E													
	3T1020-CR1.0-ME													
	3T1020-CR1.25-ME													
	3T1020-CR1.5-ME													
	3T1020-CR2.0-ME													

- ■ Steel ■ Stainless Steel ⊗ Steel/Stainless Steel/Super alloy ■ Cast Iron ■ Aluminum ■ Steel/Cast Iron
- ⊗ Steel/Stainless Steel/Cast Iron
- Prices and stocks are based on present conditions
- Please specify model numbers and the grade of inserts, ie.: 3T1020-CR1.0-E, F20

UFO Circlip Inserts

- Toolholders P. 26
- Cutting Data P. 135 - 136



DIN471









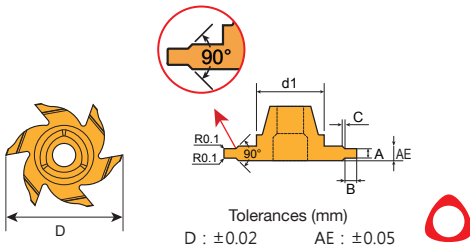

DIN472









Offer customized items at standard prices by MOQ 12 pcs



Dimensions (mm)						
D	d1	A	Circlip	B	C	AE
20	10	1.21	1.1	0.5	0.1	2.2
		1.41	1.3	0.85		
		1.71	1.6	1.0		
		1.96	1.85	1.25	0.2	3
		2.26	2.15	1.5		3.5
		2.76	2.65	1.75		4
		3.26	3.15	1.75		5
		4.26	4.15	2.0		

Inserts	Order Code	Grades							 E  ME		
		Carbide					Metal cermet	Uncoated			
		B100	C200	C250	F20	F30	CE25	CE60		K10	CE
 <p>6 flutes</p>	C3T1020-1.1-E										     
	C3T1020-1.3-E										
	C3T1020-1.6-E										
	C3T1020-1.85-E										
	C3T1020-2.15-E										
	C3T1020-2.65-E										
	C3T1020-3.15-E										
	C3T1020-4.15-E										
	C3T1020-1.1-ME		⊙								
	C3T1020-1.3-ME		⊙								
	C3T1020-1.6-ME		⊙								
	C3T1020-1.85-ME		⊙								
	C3T1020-2.15-ME		⊙								
	C3T1020-2.65-ME		⊙								
C3T1020-3.15-ME		⊙									
C3T1020-4.15-ME		⊙									

Inserts 6 PCS / Box

-  Steel  Stainless Steel  Steel/Stainless Steel/Super alloy  Cast Iron  Aluminum  Steel/Cast Iron  Steel/Stainless Steel/Cast Iron
- Prices and stocks are based on present conditions
- Please specify model numbers and the grade of inserts, ie.: C3T1020-1.1-E,K10



UFO THREAD MILLING



Features

Available in materials



Cost
200~300%
SAVING

Applicable
Machines
CNC Milling machine

Efficiency
400%
UP

Durability
300%
UP



1 / Excellent chip evacuation

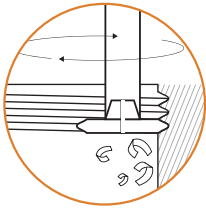

2 / High stability & Low cutting forces

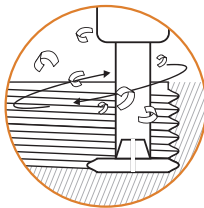

3 / Same insert can make different pitches of thread.

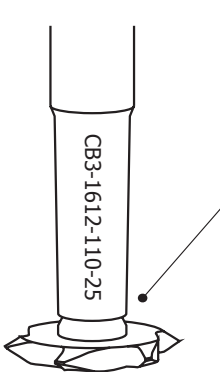
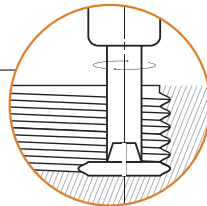

Product Advantages

Indexable UFO thread mill - Excellent in chip evacuation and small cutting force.

Insert Design

1. Yih Troun provides UFO thread milling inserts applicable to metric, UN and withworth both in full profile and partial profile. Full profile inserts are available from $\text{Ø}10/\text{pitch}1.0$; partial profile inserts are available from $\text{Ø}12/\text{pitch}1.0$.
2. Unique tapered polygon design to get the excellent stability in high speed machining.
3. The front-mounted insert are positioned in a taper seat for center-positioning, giving secure and continuous performance.
4. High productivity with many teeth (4-6 teeth).

New

UFO thread mill is the best choice for expensive components, it's excellent in chip evacuation, averts chip twining and tap breakage at the last stage of machining, exempts machines from unscheduled down time.

The UFO thread mill insert generates machining cutting force least from its single-point design. It's the first choice for medium to large threads milling in BT30 CNC machining centers, thin-walled components and unstable conditions such as milling thread with a long overhang.

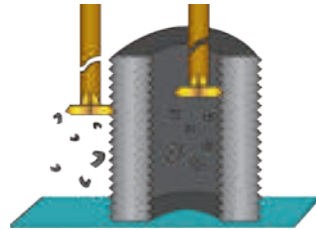

Old

Machining with conventional HSS/ carbide solid tap gets problems easily in chip evacuation, tap breakage on the parts and machining stoppage, It takes time and cost to remove the breakage tap.



Advantages Of Partial Profile Ufo Thread Milling

FIG.1

Same UFO thread milling insert is applicable to a wide range of hole sizes and thread pitches.

If use taps, it needs different taps for different hole sizes and different pitches.

FIG.2

UFO thread milling achieves full-bottom threading in a blind hole with a least drill depth.

It's easy to fix thread tolerance by programme.

FIG.3

Same UFO thread milling inserts can be used in PT(NPT) thread.



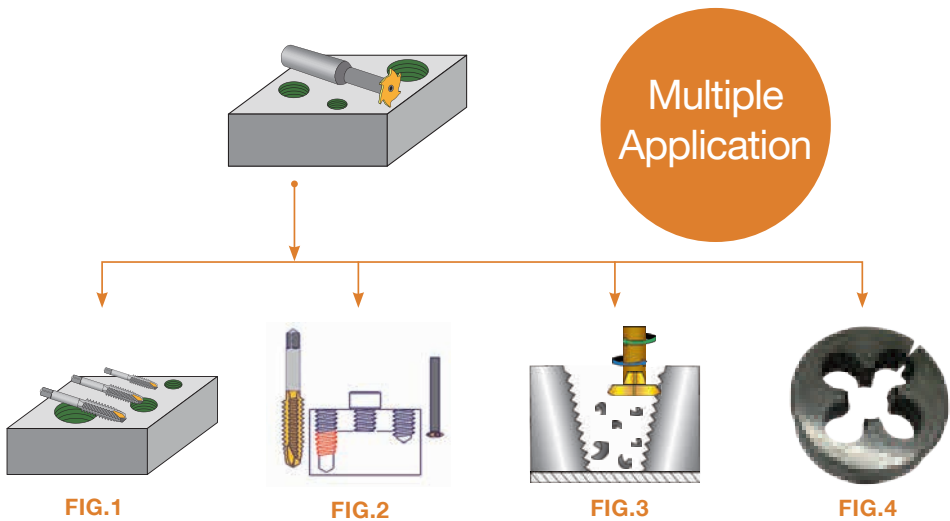

It provides better tool life and less cutting force than PT tap.

FIG.4

Same UFO thread milling insert is available for both external and internal threads.



Tools Comparison

UFO partial profile insert	Tap	Solid carbide thread milling	Thread milling insert
			
One insert applicable to a wide pitch range	Single pitch	Single pitch	Single pitch
		Expensive	
Min dia. 12mm , 4~6 teeth			Large size and less no. of tooth
	Deeper pre-drilling hole is required		
Single cutting edge with multiple teeth results in less cutting force, available even in small horse power M/C	Bigger horse power M/C is required in big hole machining	Multiple pitches design results in higher cutting force and lower feed in machining difficult material	Multiple pitches design results in higher cutting force and lower feed in machining difficult material
Less cutting force in machining taper thread	Additional taper tap is required	Not available in taper thread	Not available in taper thread

Precise Thread By UFO Thread Milling

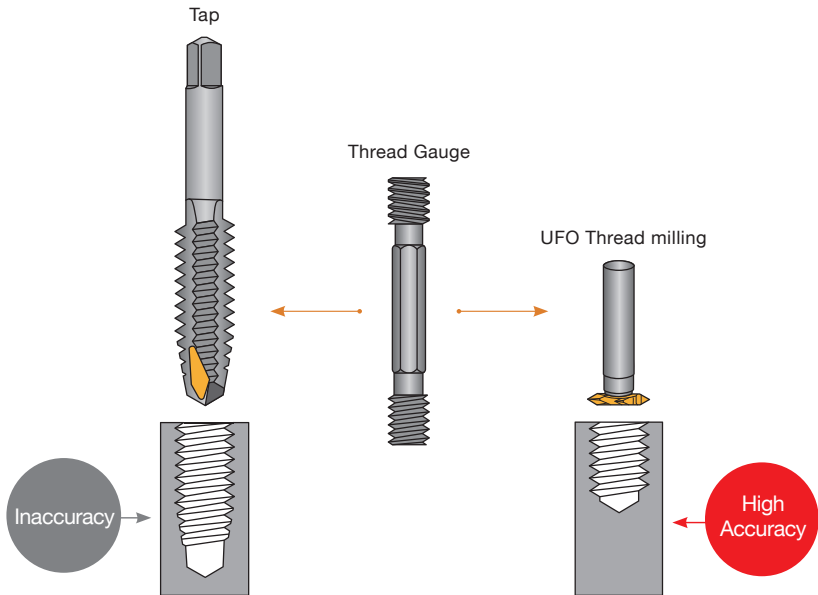

Solid Carbide Thread Milling - Partial Profile 60°

• Cutting Data P. 141

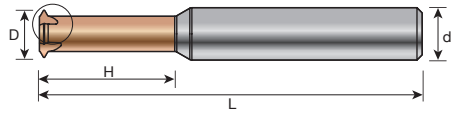
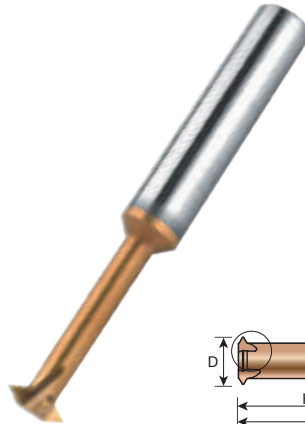
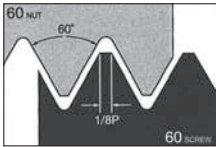

Order code	Pitch Range		D	H	T	d	L
	MM	TPI					
AT0195-50	0.35-0.6	72-40	1.95	6.0	3	3	50
AT0245-50	0.5-0.8	48-32	2.45	7.7	3	3	50
AT0315-50	0.5-0.8	48-32	3.15	10	3	4	50
AT0400-50	0.5-1.0	48-24	4.0	12	3	4	50
AT0470-60	0.5-1.25	48-20	4.7	15	3	6	60
AT0600-60	0.5-1.25	48-20	6.0	18	3	6	60
AT0800-60	0.75-1.5	32-16	8.0	24	3	8	60
AT1000-80	1.0-2.5	24-10	10	30	4	10	80



Solid Carbide Thread Milling 2D (Full-Profile) 60°

• Cutting Data P. 141

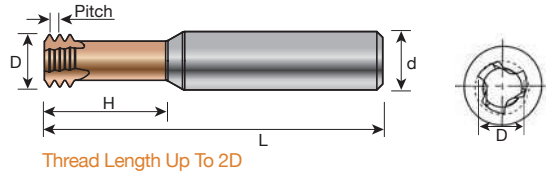
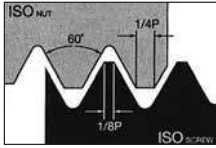

Order code	Thread Size	Pitch	D	H	T	d	L
BT0240-50	M3.0 X 0.5	0.5	2.4	6.4	3	4	50
BT0275-50	M3.5 X 0.6	0.6	2.75	7.4	3	4	50
BT0315-60	M4 X 0.7	0.7	3.15	8.6	3	6	60
BT0400-60	M5 X 0.8	0.8	4.0	12.0	3	6	60
BT0475-60	M6 X 1.0	1.0	4.75	13.0	3	6	60
BT0600-60	M8 X 1.25	1.25	6.5	17.3	3	8	60
BT0790-60	M10 X 1.5	1.5	7.9	22.0	3	8	60
BT0950-80	M12 X 1.75	1.75	9.5	25.5	3	10	80

Solid Carbide Thread Milling 3D (Full-Profile) 60°

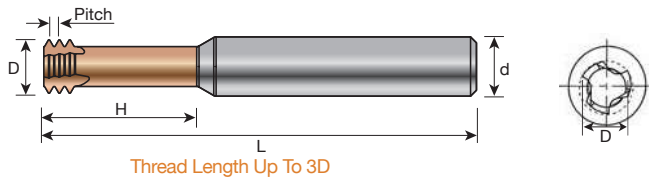
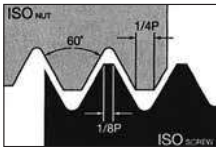

Order code	Thread Size	Pitch	D	H	T	d	L
BTL0240-50	M3.0 X 0.5	0.5	2.4	9.3	3	4	50
BTL0315-60	M4.0 X 0.7	0.7	3.15	12.4	3	6	60
BTL0400-60	M5 X 0.8	0.8	4.0	15.6	3	6	60
BTL0475-60	M6 X 1.0	1.0	4.75	19.0	3	6	60
BTL0650-60	M8 X 1.25	1.25	6.5	24.3	3	8	60
BTL0790-60	M10 X 1.5	1.5	7.9	31.0	3	8	60
BTL0950-80	M12 X 1.75	1.75	9.5	36.5	3	10	80

Solid Carbide Thread Milling 2D (Full-Profile) UN 60°

• Cutting Data P. 141

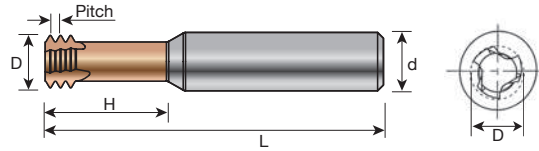
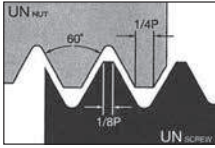

Thread Length Up To 2D

Order code	UNC	UNF	T.P.I	D	H	T	d	L
UT404-50	No.5 - 40 UNC	No.6 - 40 UNF	40	2.46	7.1	3	4	50
UT364-50	-	No.8 - 36 UNF	36	3.31	8.8	3	4	50
UT324-50	No.6 - 32 UNC	-	32	2.57	7.3	3	4	50
UT326-60	No.8 - 32 UNC	No.10 - 32 UNF	32	3.22	10.1	3	6	60
UT286-60	-	1/4 - 28 UNF	28	5.2	14	3	6	60
UT246-60	No.10 - 24 UNC	-	24	3.55	10.4	3	6	60
UT248-60	-	5/16 - 24 UNF	24	6.65	16.7	3	8	60
UT206-60	1/4 - 20 UNC	7/16 - 20 UNF	20	4.85	13.7	3	6	60
UT208-60	-	7/16 - 20 UNF	20	7.95	24	3	8	60
UT186-60	5/16 - 18 UNC	-	18	5.95	16.5	3	6	60
UT168-60	3/8 - 16 UNC	-	16	6.9	21	3	8	60
UT148-60	7/16 - 14 UNC	-	14	7.95	23.5	3	8	60
UT1310-80	1/2 - 13 UNC	-	13	9.3	27	3	10	80

Solid Carbide Thread Milling 3D (Full-Profile) UN 60°

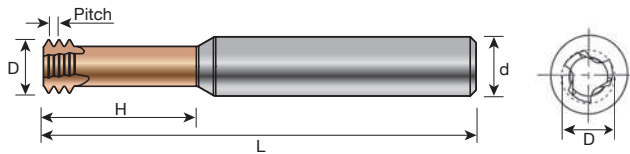
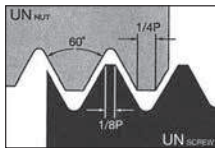

Thread Length Up To 3D

Order code	UNC	UNF	T.P.I	D	H	T	d	L
UTL404-50	No.5 - 40 UNC	No.6 - 40 UNF	40	2.46	9.8	3	4	50
UTL324-60	No.6 - 32 UNC	-	32	2.57	10.7	3	4	50
UTL326-60	No.8 - 32 UNC	No.10 - 32 UNF	32	3.22	12.7	3	6	60
UTL286-60	-	1/4 - 28 UNF	28	5.2	19.3	3	6	60
UTL248-60	-	5/16 - 24 UNF	24	6.65	24.2	3	8	60
UTL206-60	1/4 - 20 UNC	7/16 - 20 UNF	20	4.85	19.4	3	6	60



UFO Thread Milling Inserts (Partial Profile)

- Toolholders P. 24
- Cutting Data P. 141 - 143

External / Internal

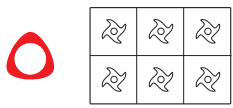
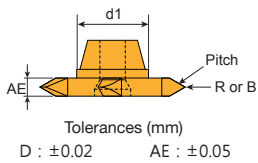
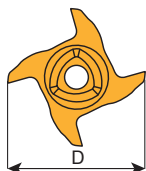
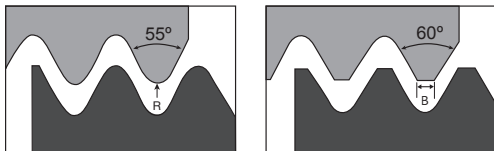

Inserts 6 PCS / Box

Dimensions (mm)									
D	d1	AE	Pitch mm	Pitch t.p.i	Angle	R	B	Minimum hole diameter	
								MM	INCH
12	6.5	3.2	-	16~10	55°	0.22	-	16.51	0.65"
		2.0	1.0~1.5	-	60°	-	0.10	14.00	-
		3.2	1.75~2.5	-		-	0.22		

Inserts	Order Code	Grades											
		Carbide				Cermet			Uncoated				
		B100	C200	C250	F20	F30	CE25	CE100	CE60	K10		CE	
<p>55° BSW/BSF</p>	3T1-0612-55-16~10TPI-E												<p>BSW Defined by: B.S.84:1956, DIN 259, ISO228/1:1982 BSF Defined by: B.S.2779:1956 Tolerance class: BSW- Medium class A, BSF-Medium class</p>
	3T1-0612-55-16~10TPI-ME	⊙											
<p>60° ISO Metric(M,MF)</p>	3T1-0612-60-1.0~1.5-E												<p>Defined by: R262 (DIN 13) Tolerance class: 6g/6H</p>
	3T1-0612-60-1.75~2.5-E												
	3T1-0612-60-1.0~1.5-ME	⊙											
	3T1-0612-60-1.75~2.5-ME	⊙											

- Steel Stainless Steel Steel/Stainless Steel/Super alloy Cast Iron Aluminum Steel/Cast Iron
- Steel/Stainless Steel/Cast Iron
- Prices and stocks are based on present conditions
- Please specify model numbers and the grade of inserts, ie.: 3T1-0612-55-16~10TPI-E,F20

UFO Thread Milling Inserts (Partial Profile)

- Toolholders P. 25
- Cutting Data P. 142 - 143

UFO Family

External / Internal

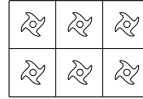
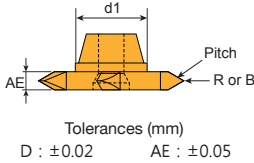
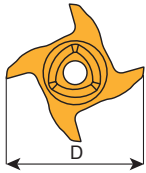
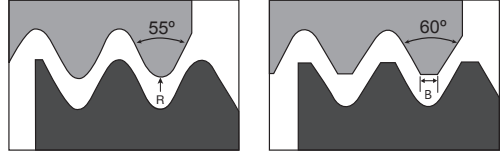

Inserts 6 PCS / Box

Dimensions (mm)									
D	d1	AE	Pitch mm	Pitch t.p.i	Angle	R	B	Minimum hole diameter	
								MM	INCH
15	7.9	4.0	-	11~8	55°	0.32	-	17.78	0.7"
		2.0	1.0~1.5	-	60°	-	0.10	17.00	-
		4.0	1.75~3.0	-		-	0.22		

Inserts	Order Code	Grades											
		Carbide					Cermet			Uncoated			
		B100	C200	C250	F20	F30	CE25	CE100	CE60	K10		CE	
 55° BSW/BSF	3T1-0815-55-11~8TPI-E												 BSW Defined by: B.S.84:1956, DIN 259, ISO228/1:1982 BSF Defined by: B.S.2779:1956 Tolerance class: BSW- Medium class A, BSF-Medium class
	3T1-0815-55-11~8TPI-ME	⊙											
 60° ISO Metric(M,MF)	3T1-0815-60-1.0~1.5-E												 Defined by: R262 (DIN 13) Tolerance class: 6g/6H
	3T1-0815-60-1.75~3.0-E												
	3T1-0815-60-1.0~1.5-ME	⊙											
	3T1-0815-60-1.75~3.0-ME	⊙											

- ■ Steel ■ Stainless Steel ⊙ Steel/Stainless Steel/Super alloy ■ Cast Iron ■ Aluminum ■ Steel/Cast Iron
- ⊙ Steel/Stainless Steel/Cast Iron
- Prices and stocks are based on present conditions
- Please specify model numbers and the grade of inserts, ie.: 3T1-0815-55-11~8TPI-E,F20



UFO Thread Milling Inserts (Partial Profile)

- Toolholders P. 26
- Cutting Data P. 142 - 143

External / Internal

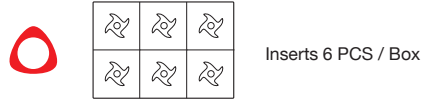
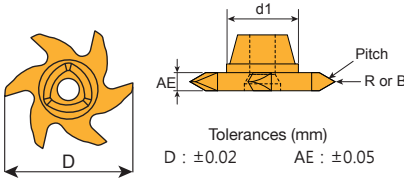
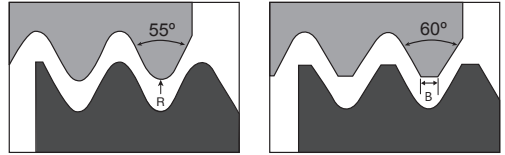

Dimensions (mm)									Minimum hole diameter	
D	d1	AE	Pitch mm	Pitch t.p.i	Angle	R	B	MM	INCH	
								20	9.9	4.6
		2.0	1.0~1.5	-	60°	-	0.10	22.00	-	
		4.6	1.75~3.5	-		-	0.22			

Inserts	Order Code	Grades											
		Carbide					Cermet			Uncoated			
		B100	C200	C250	F20	F30	CE25	CE100	CE60	K10		CE	
 55° BSW/BSF	3T1-1020-55-11~6TPI-E												 BSW Defined by: B.S.84:1956, DIN 259, ISO228/1:1982 BSF Defined by: B.S.2779:1956 Tolerance class: BSW- Medium class A, BSF-Medium class
	3T1-1020-55-11~6TPI-ME	⊙											
 60° ISO Metric(M,MF)	3T1-1020-60-1.0~1.5-E												 Defined by: R262 (DIN 13) Tolerance class:6g/6H
	3T1-1020-60-1.75~3.5-E												
	3T1-1020-60-1.0~1.5-ME	⊙											
	3T1-1020-60-1.75~3.5-ME	⊙											

- Steel Stainless Steel Steel/Stainless Steel/Super alloy Cast Iron Aluminum Steel/Cast Iron
- Steel/Stainless Steel/Cast Iron
- Prices and stocks are based on present conditions
- Please specify model numbers and the grade of inserts, ie.: 3T1-1020-55-11~6TPI-E,F20

UFO Thread Milling Inserts (Partial Profile)

- Toolholders P. 27
- Cutting Data P. 142 - 143

UFO Family

External / Internal

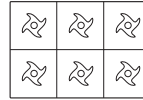
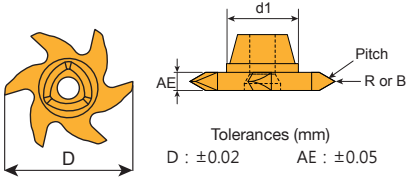
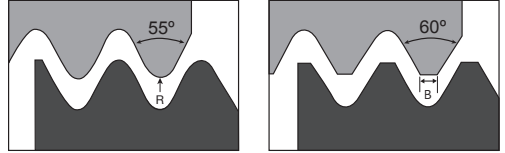

Inserts 6 PCS / Box

Dimensions (mm)									
D	d1	AE	Pitch mm	Pitch t.p.i	Angle	R	B	Minimum hole diameter	
								MM	INCH
25	12	4.6	-	11~5	55°	0.32	-	28.58	1.125"
		2.0	1.0~1.5	-	60°	-	0.10	-	-
		4.6	1.75~5.0	-	-	-	0.22	27.00	-

Inserts	Order Code	Grades											
		Carbide				Cermet			Uncoated				
		B100	C200	C250	F20	F30	CE25	CE100	CE60	K10		CE	
 55° BSW/BSF	3T1-1225-55-11~5TPI-E												 BSW Defined by: B.S.84:1956, DIN 259, ISO228/1:1982 BSF Defined by: B.S.2779:1956 Tolerance class: BSW-Medium class A, BSF-Medium class
	3T1-1225-55-11~5TPI-ME	⊙											
 60° ISO Metric(M,MF)	3T1-1225-60-1.0~1.5-E												 Defined by: R262 (DIN 13) Tolerance class: 6g/6H
	3T1-1225-60-1.75~5.0-E												
	3T1-1225-60-1.0~1.5-ME	⊙											
	3T1-1225-60-1.75~5.0-ME	⊙											

- ■ Steel ■ Stainless Steel ⊙ Steel/Stainless Steel/Super alloy ■ Cast Iron ■ Aluminum ■ Steel/Cast Iron
- ⊙ Steel/Stainless Steel/Cast Iron
- Prices and stocks are based on present conditions
- Please specify model numbers and the grade of inserts, ie.: 3T1-1225-55-11~5TPI-E, F20



UFO Thread Milling Inserts (Full Profile) - Internal threads

- Toolholders P. 24
- Cutting Data P. 142 - 143

ISO

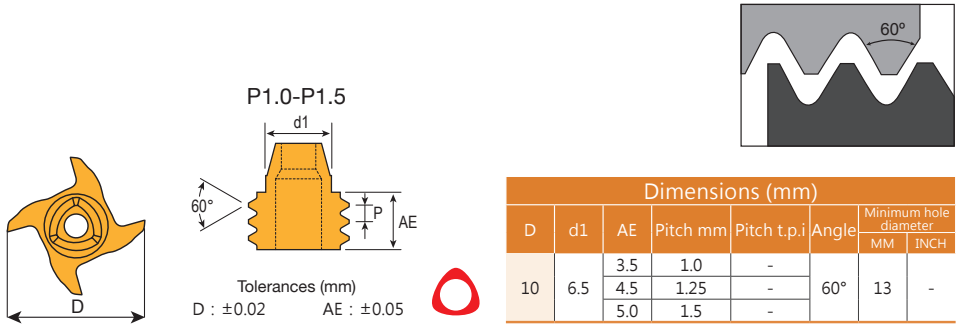

Inserts	Order Code	Grades									
		Carbide					Cermet		Uncoated		
		B100	C200	C250	F20	F30	CE100	CE60	K10		CE
<p>ISO Metric(M,MF)</p>	3T0610-ISO1.0-E										
	3T0610-ISO1.25-E										
	3T0610-ISO1.5-E										

Defined by: R262 (DIN 13)
Tolerance class:6g/6H

Inserts 6 PCS / Box

- ■ Steel ■ Stainless Steel ⊗ Steel/Stainless Steel/Super alloy ■ Cast Iron ■ Aluminum ■ Steel/Cast Iron
- ⊗ Steel/Stainless Steel/Cast Iron
- Prices and stocks are based on present conditions
- Please specify model numbers and the grade of inserts, ie.: 3T0610-ISO1.0-E, F20

UFO Thread Milling Inserts (Full Profile) - Internal threads

- Toolholders P. 24
- Cutting Data P. 142 - 143

ISO

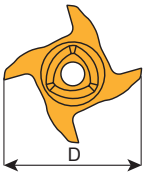
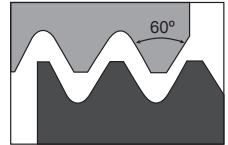
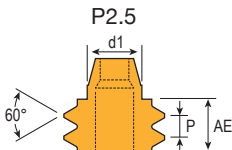
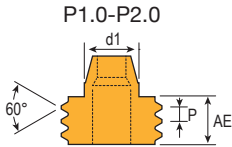

Tolerances (mm)
D : ±0.02 AE : ±0.05



Dimensions (mm)						
D	d1	AE	Pitch mm	Pitch t.p.i	Angle	Minimum hole diameter
						MM INCH
12	6.5	3.5	1.0	-	60°	14
		4.5	1.25	-		16
		5.0	1.5	-		
		6.5	2.0	-		
		5.5	2.5	-		

Inserts	Order Code	Grades									
		Carbide					Cermet		Uncoated		
		B100	C200	C2.50	F20	F30	CE100	CE60	K10		CE
<p>ISO Metric(M,MF)</p>	3T0612-ISO1.0-E										<p>Defined by: R262 (DIN 13) Tolerance class: 6g/6H</p>
	3T0612-ISO1.25-E										
	3T0612-ISO1.5-E										
	3T0612-ISO2.0-E										
	3T0612-ISO2.5-E										
	3T0612-ISO1.0-ME										<p>Inserts 6 PCS / Box</p>
	3T0612-ISO1.25-ME										
	3T0612-ISO1.5-ME										
	3T0612-ISO2.0-ME										
	3T0612-ISO2.5-ME										

- ■ Steel ■ Stainless Steel ⊗ Steel/Stainless Steel/Super alloy ■ Cast Iron ■ Aluminum ■ Steel/Cast Iron
- ⊗ Steel/Stainless Steel/Cast Iron
- Prices and stocks are based on present conditions
- Please specify model numbers and the grade of inserts, ie.: 3T0612-ISO1.0-E, F20



UFO Thread Milling Inserts (Full Profile) - Internal threads

- Toolholders P. 24
- Cutting Data P. 142 - 143

UNC

TPI 16 - TPI 13

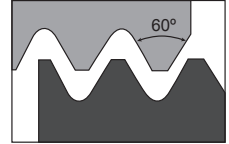
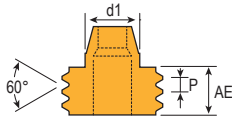

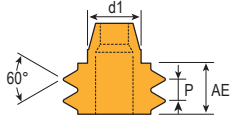
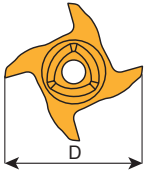

TPI 12 - TPI 10



Tolerances (mm)
D : ±0.02 AE : ±0.05



Dimensions (mm)						
D	d1	AE	Pitch mm	Pitch t.p.i	Angle	Minimum hole diameter
						MM INCH
12	6.5	5.0	-	16	60°	14 0.55"
		6.0	-	14		
		6.5	-	13		
		4.5	-	12		
		5.0	-	11		
		5.5	-	10		

Inserts	Order Code	Grades									
		Carbide					Cermet		Uncoated		
		B100	C200	C250	F20	F30	CE100	CE60	K10		CE
 UNC/UNF	3T0612-UNC16-E										
	3T0612-UNC14-E										
	3T0612-UNC13-E										
	3T0612-UNC12-E										
	3T0612-UNC11-E										
	3T0612-UNC10-E										
	3T0612-UNC16-ME										
	3T0612-UNC14-ME										
	3T0612-UNC13-ME										
	3T0612-UNC12-ME										
	3T0612-UNC11-ME										
	3T0612-UNC10-ME										

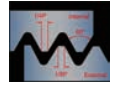

Defined by: R262 (DIN 13)
Tolerance class:Gg/6H

* M.O.Q: 12PCS
* Make-to-Order.

- ■ Steel ■ Stainless Steel ⊗ Steel/Stainless Steel/Super alloy ■ Cast Iron ■ Aluminum ■ Steel/Cast Iron
- ⊗ Steel/Stainless Steel/Cast Iron
- Prices and stocks are based on present conditions
- Please specify model numbers and the grade of inserts, ie.: 3T0612-UNC16-E,F20

UFO Thread Milling Inserts (Full Profile) - Internal threads

- Toolholders P. 24
- Cutting Data P. 142 - 143

BSW

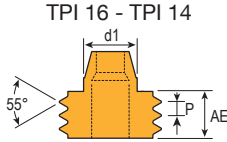

TPI 16 - TPI 14

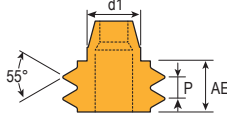
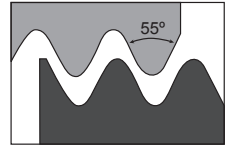

TPI 12 - TPI 10

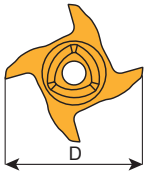

Tolerances (mm)
D : ±0.02 AE : ±0.05



Dimensions (mm)							
D	d1	AE	Pitch mm	Pitch t.p.i	Angle	Minimum hole diameter	
						MM	INCH
12	6.5	5.0	-	16	55°	16.51	0.65"
		5.5	-	14			
		4.5	-	12			
		5.0	-	11			
		5.5	-	10			

Inserts	Order Code	Grades									
		Carbide					Cermet		Uncoated		
		B100	C200	C250	F20	F30	CE100	CE60	K10		CE
<p>BSW/BSF</p>	3T0612-BSW16-E										
	3T0612-BSW14-E										
	3T0612-BSW12-E										
	3T0612-BSW11-E										
	3T0612-BSW10-E										
	3T0612-BSW16-ME										
	3T0612-BSW14-ME										
	3T0612-BSW12-ME										
	3T0612-BSW11-ME										
	3T0612-BSW10-ME										

BSW Defined by:
B.S.84:1956,
DIN 259, ISO228/1:1982
BSF Defined by:
B.S.2779:1956
Tolerance class: BSW-
Medium class A, BSF-Medium class

* M.O.Q: 12PCS
* Make-to-Order.

- ■ Steel ■ Stainless Steel ● Steel/Stainless Steel/Super alloy ■ Cast Iron ■ Aluminum ■ Steel/Cast Iron
- ■ Steel/Stainless Steel/Cast Iron
- Prices and stocks are based on present conditions
- Please specify model numbers and the grade of inserts, i.e.: 3T0612-BSW16-E,F20



UFO Thread Milling Inserts (Full Profile) - Internal threads

- Toolholders P. 25
- Cutting Data P. 142 - 143

ISO

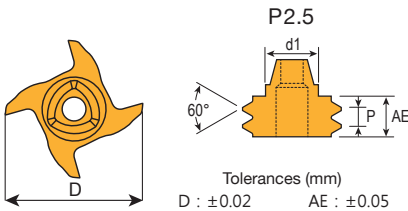
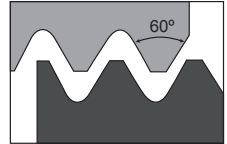
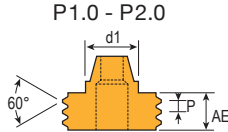

Dimensions (mm)							
D	d1	AE	Pitch mm	Pitch t.p.i	Angle	Minimum hole diameter	
						MM	INCH
15	7.9	3.5	1.0	-	60°	17	-
		4.5	1.25	-			
		5.0	1.5	-			
		6.5	2.0	-			
		5.5	2.5	-			

Inserts	Order Code	Grades									
		Carbide					Cermet		Uncoated		
		B100	C200	C250	F20	F30	CE100	CE60	K10		CE
<p>ISO Metric (M,MF)</p>	3T0815-ISO1.0-E										
	3T0815-ISO1.25-E										
	3T0815-ISO1.5-E										
	3T0815-ISO2.0-E										
	3T0815-ISO2.5-E										

Defined by: R262 (DIN 13)
Tolerance class: 6g/6H

Inserts 6 PCS / Box

- ■ Steel ■ Stainless Steel ■ Steel/Stainless Steel/Super alloy ■ Cast Iron ■ Aluminum ■ Steel/Cast Iron
- ■ Steel/Stainless Steel/Cast Iron
- Prices and stocks are based on present conditions
- Please specify model numbers and the grade of inserts, ie.: 3T0815-ISO1.0-E,F20

UFO Thread Milling Inserts (Full Profile) - Internal threads

- Toolholders P. 25
- Cutting Data P. 142 - 143

UNC

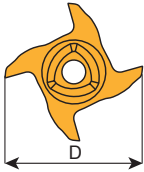
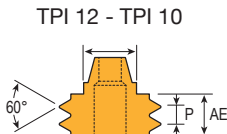
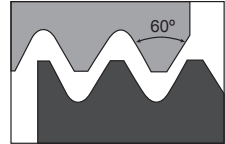
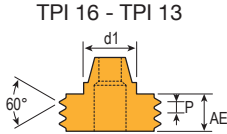

Tolerances (mm)
D : ±0.02 AE : ±0.05



Dimensions (mm)							
D	d1	AE	Pitch mm	Pitch t.p.i	Angle	Minimum hole diameter	
						MM	INCH
15	7.9	5.0	-	16	60°	17.78	0.7"
		6.0	-	14			
		6.5	-	13			
		4.5	-	12			
		5.0	-	11			
		5.5	-	10			

Inserts	Order Code	Grades										
		Carbide					Cermet		Uncoated			
		B100	C200	C250	F20	F30	CEI100	CE60	K10	CE		
<p>UNC/UNF</p>	3T0815-UNC16-E											<p>Defined by: R262 (DIN 13) Tolerance class: 6g/6H</p>
	3T0815-UNC14-E											
	3T0815-UNC13-E											
	3T0815-UNC12-E											
	3T0815-UNC11-E											
	3T0815-UNC10-E											
	3T0815-UNC16-ME	☉										
	3T0815-UNC14-ME	☉										
	3T0815-UNC13-ME	☉										
	3T0815-UNC12-ME	☉										
	3T0815-UNC11-ME	☉										
	3T0815-UNC10-ME	☉										

* M.O.Q: 12PCS
* Make-to-Order.

- ■ Steel ■ Stainless Steel ⊗ Steel/Stainless Steel/Super alloy ■ Cast Iron ■ Aluminum ■ Steel/Cast Iron
- ⊗ Steel/Stainless Steel/Cast Iron
- Prices and stocks are based on present conditions
- Please specify model numbers and the grade of inserts, i.e.: 3T0815-UNC16-E,F20



UFO Thread Milling Inserts (Full Profile) - Internal threads

- Toolholders P. 25
- Cutting Data P. 142 - 143

BSW

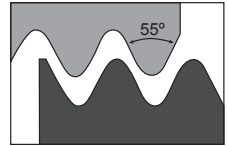
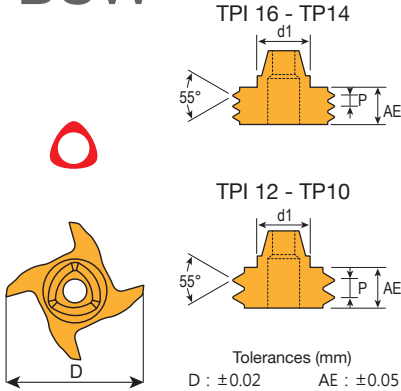

Dimensions (mm)							
D	d1	AE	Pitch mm	Pitch t.p.i	Angle	Minimum hole diameter	
						MM	INCH
15	7.9	5.0	-	16	55°	18.03	0.71"
		5.5	-	14			
		4.5	-	12			
		5.0	-	11			
		5.5	-	10			

Inserts	Order Code	Grades									
		Carbide					Cermet		Uncoated		
		B100	C200	C250	F20	F30	CE100	CE60	K10	CE	
 BSW/BSF	3T0815-BSW16-E										
	3T0815-BSW14-E										
	3T0815-BSW12-E										
	3T0815-BSW11-E										
	3T0815-BSW10-E										
	3T0815-BSW16-ME										
	3T0815-BSW14-ME										
	3T0815-BSW12-ME										
3T0815-BSW11-ME											
3T0815-BSW10-ME											



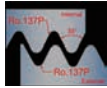

BSW Defined by:
B.S.84:1956
DIN 259, ISO228/1:1982
BSF Defined by:
B.S.2779:1956
Tolerance class: BSW-
Medium
class A, BSF-Medium class

* M.O.Q: 12PCS
* Make-to-Order.

- ■ Steel ■ Stainless Steel ■ Steel/Stainless Steel/Super alloy ■ Cast Iron ■ Aluminum ■ Steel/Cast Iron
- ■ Steel/Stainless Steel/Cast Iron
- Prices and stocks are based on present conditions
- Please specify model numbers and the grade of inserts, ie.: 3T1020-BSW16-E,F20

UFO Thread Milling Inserts (Full Profile) - Internal threads

- Toolholders P. 26
- Cutting Data P. 142 - 143

UFO Family

ISO

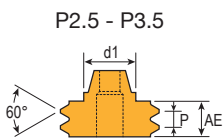
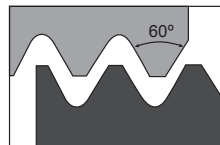
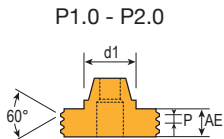

Tolerances (mm)
D : ±0.02 AE : ±0.05



Dimensions (mm)							
D	d1	AE	Pitch mm	Pitch t.p.i	Angle	Minimum hole diameter	
						MM	INCH
20	9.9	3.5	1.0	-	60°	22	-
		4.5	1.25	-		24	
		5.0	1.5	-			
		6.5	2.0	-		26	
		5.5	2.5	-			
		6.5	3.0	-			
		7.5	3.5	-			

Inserts	Order Code	Grades									
		Carbide					Cermet		Uncoated		
		B100	C200	C250	F20	F30	CE100	CE60	K10		CE
<p>ISO Metric (M,MF)</p>	3T1020-ISO1.0-E										<p>Defined by: R262 (DIN 13) Tolerance class:6g/6H</p>
	3T1020-ISO1.25-E										
	3T1020-ISO1.5-E										
	3T1020-ISO2.0-E										
	3T1020-ISO2.5-E										
	3T1020-ISO3.0-E										
	3T1020-ISO3.5-E										
	3T1020-ISO1.0-ME	⊙									<p>Inserts 6 PCS / Box</p>
	3T1020-ISO1.25-ME	⊙									
	3T1020-ISO1.5-ME	⊙									
	3T1020-ISO2.0-ME	⊙									
	3T1020-ISO2.5-ME	⊙									
	3T1020-ISO3.0-ME	⊙									
	3T1020-ISO3.5-ME	⊙									

- ■ Steel ■ Stainless Steel ⊙ Steel/Stainless Steel/Super alloy ■ Cast Iron ■ Aluminum ■ Steel/Cast Iron
- ⊙ Steel/Stainless Steel/Cast Iron
- Prices and stocks are based on present conditions
- Please specify model numbers and the grade of inserts, ie.: 3T1020-ISO1.0-E,F20



UFO Thread Milling Inserts (Full Profile) - Internal threads

- Toolholders P. 26
- Cutting Data P. 142 - 143

UNC

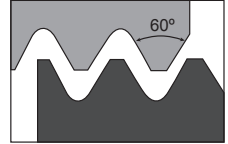
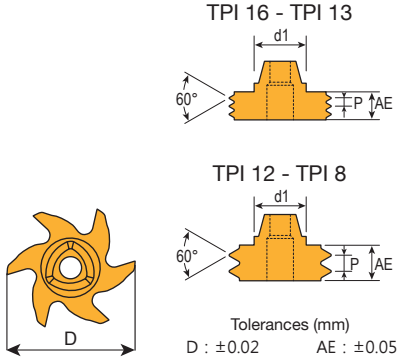

Dimensions (mm)							
D	d1	AE	Pitch mm	Pitch t.p.i	Angle	Minimum hole diameter	
						MM	INCH
20	9.9	5.0	-	16	60°	22.86	0.9"
		6.0	-	14			
		6.5	-	13			
		4.5	-	12			
		5.0	-	11			
		5.5	-	10			
		6.0	-	9			
		7.0	-	8			

Inserts	Order Code	Grades											
		Carbide					Cermet		Uncoated				
		B100	C200	C250	F20	F30	CE100	CE60	K10	CE			
 UNC/UNF	3T1020-UNC16-E												 Defined by: R262 (DIN 13) Tolerance class: 6g/6H
	3T1020-UNC14-E												
	3T1020-UNC13-E												
	3T1020-UNC12-E												
	3T1020-UNC11-E												
	3T1020-UNC10-E												
	3T1020-UNC9-E												
	3T1020-UNC8-E												
	3T1020-UNC16-ME	☉											* M.O.Q: 12PCS * Make-to-Order.
	3T1020-UNC14-ME	☉											
	3T1020-UNC13-ME	☉											
	3T1020-UNC12-ME	☉											
	3T1020-UNC11-ME	☉											
	3T1020-UNC10-ME	☉											
	3T1020-UNC9-ME	☉											
	3T1020-UNC8-ME	☉											

- Steel Stainless Steel Steel/Stainless Steel/Super alloy Cast Iron Aluminum Steel/Cast Iron
- Steel/Stainless Steel/Cast Iron
- Prices and stocks are based on present conditions
- Please specify model numbers and the grade of inserts, ie.: 3T1020-UNC16-E,F20

UFO Thread Milling Inserts (Full Profile) - Internal threads

- Toolholders P. 26
- Cutting Data P. 142 - 143

BSW

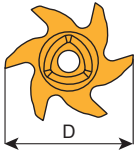
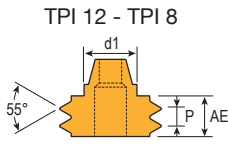
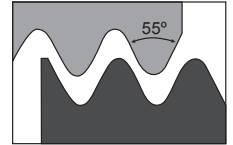
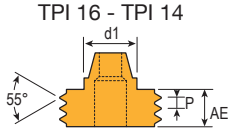

UFO Family



Tolerances (mm)
D : ±0.02 AE : ±0.05

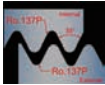

Dimensions (mm)							
D	d1	AE	Pitch mm	Pitch t.p.i	Angle	Minimum hole diameter	
						MM	INCH
20	9.9	5.0	-	16	55°	22.86	0.9"
		5.5	-	14			
		4.5	-	12			
		5.0	-	11			
		5.5	-	10			
		6.0	-	9			
7.0	-	8					

Inserts	Order Code	Grades								
		Carbide					Cermet		Uncoated	
		B100	C200	C250	F20	F30	CE100	CE60	K10	
 BSW/BSF	3T1020-BSW16-E									 BSW Defined by: B.S.84:1956, DIN 259, ISO228/1:1982 BSF Defined by: B.S.2779:1956 Tolerance class: BSW- Medium class A, BSF-Medium class
	3T1020-BSW14-E									
	3T1020-BSW12-E									
	3T1020-BSW11-E									
	3T1020-BSW10-E									
	3T1020-BSW9-E									
	3T1020-BSW8-E									
	3T1020-BSW16-ME									
	3T1020-BSW14-ME									
	3T1020-BSW12-ME									
	3T1020-BSW11-ME									
	3T1020-BSW10-ME									
	3T1020-BSW9-ME									
	3T1020-BSW8-ME									

* M.O.Q: 12PCS
* Make-to-Order.

- ■ Steel ■ Stainless Steel ⊗ Steel/Stainless Steel/Super alloy ■ Cast Iron ■ Aluminum ■ Steel/Cast Iron
- ⊗ Steel/Stainless Steel/Cast Iron
- Prices and stocks are based on present conditions
- Please specify model numbers and the grade of inserts, ie.: 3T1020-BSW16-E,F20



TECHNICAL GUIDE

Thread Infeed Depth and Number of Passes Recommendation

Below recommended data are applicable to steel

• External ISO - metric threads

Pitch(mm)	6.0	5.5	5.0	4.5	4.0	3.5	3.0	2.5	2.0	1.75	1.5	1.25	1.0	0.80	0.75	0.50
Tot.inf.depth (mm)	3,82	3,52	3,19	2,87	2,53	2,23	1,92	1,60	1,25	1,13	0,93	0,81	0,65	0,52	0,48	0,48
Pass 1 (mm)	1,50	1,50	1,30	1,60	1,53	1,23	1,0	1,60	1,25	1,13	0,93	0,81	0,65	0,52	0,48	0,48
Pass 2 (mm)	1,30	1,20	1,10	1,37	1,0	1,0	0,92	-	-	-	-	-	-	-	-	-
Pass 3 (mm)	1,02	0,82	0,79	-	-	-	-	-	-	-	-	-	-	-	-	-

• Internal ISO-metric threads

Pitch(mm)	6.0	5.5	5.0	4.5	4.0	3.5	3.0	2.5	2.0	1.75	1.5	1.25	1.0	0.80	0.75	0.50
Tot.inf.depth (mm)	3,54	3,25	2,96	2,65	2,33	2,05	1,78	1,48	1,17	1,05	0,85	0,75	0,60	0,49	0,46	0,31
Pass 1 (mm)	1,50	1,30	1,60	1,50	1,33	1,10	1,0	1,48	1,17	1,05	0,85	0,75	0,60	0,49	0,46	0,31
Pass 2 (mm)	1,20	1,10	1,39	1,15	1,0	0,95	0,78	-	-	-	-	-	-	-	-	-
Pass 3 (mm)	0,84	0,85	-	-	-	-	-	-	-	-	-	-	-	-	-	-

• Internal-Inch threads

Pitch TPI	4.0	4.5	5.0	6.0	7.0	8.0	9.0	10	11	12	14	16	18	19	20	26	28
Tot.inf.depth (mm)	4,29	3,82	3,44	2,96	2,50	2,17	1,93	1,76	1,58	1,45	1,20	1,13	1,01	0,96	0,92	0,72	0,69
Pass 1 (mm)	1,50	1,50	1,50	1,60	1,40	1,20	1,10	1,76	1,58	1,45	1,20	1,13	1,01	0,96	0,92	0,72	0,69
Pass 2 (mm)	1,50	1,30	1,20	1,36	1,10	0,97	0,83	-	-	-	-	-	-	-	-	-	-
Pass 3 (mm)	1,29	1,02	0,74	-	-	-	-	-	-	-	-	-	-	-	-	-	-

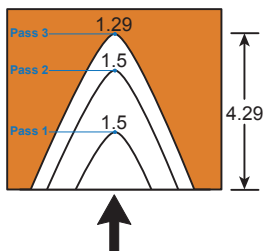

Example of thread infeed method

- To stainless steel, the infeed depth per pass should be decreased.
- The threading insert nose radius is relatively small and can be easily damaged if it is overloaded.

Technical Guide

Internal Thread

1

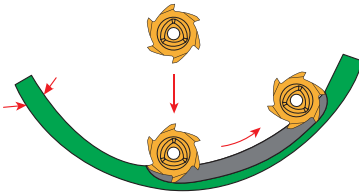

Plunging is not recommended

2

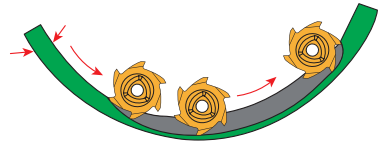

Ramping is the best choice

Highly Recommended

- ① Plunging to mill : Fz reduce to 50%
- ② Ramping to mill : Fz remain 100%

External Thread

1

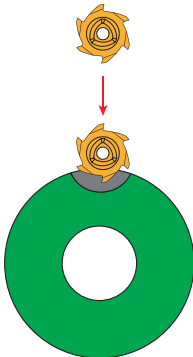

Plunging is not recommended

2

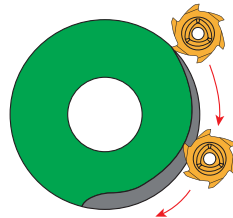

Ramping is the best choice

Highly Recommended



About Thread Milling

In order to perform a thread milling operation, a milling machine with three-axis control capable of helical interpolation is required. Helical interpolation is a CNC function, producing movement along helical paths. This helical motion combines circular movements in the X and Y planes and perpendicular linear motions in the Z plane simultaneously. For example, the path from point A to point B (Fig.A) on the surface of the cylinder making a circular movement in the xy plane with a linear displacement in the Z direction.

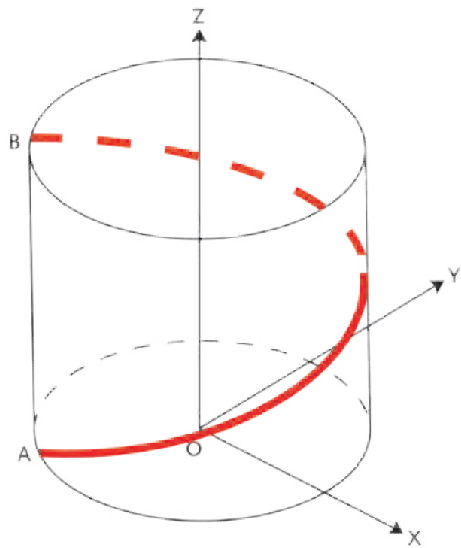
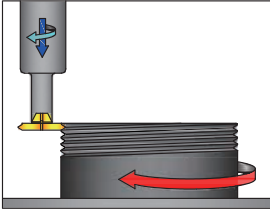

Fig. A

Thread Milling Methods

External

FIG.1



Highly Recommended

Right Hand Thread-Climb Milling

FIG.2

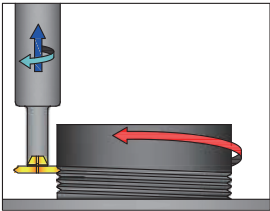

Highly Recommended

Left Hand Thread- Climb Milling

FIG.3

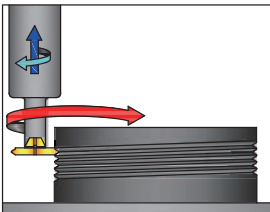

Right Hand Thread-
Conventional Milling

FIG.4

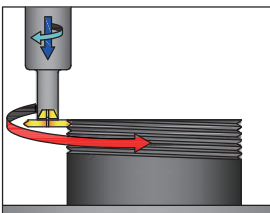

Left Hand Thread-
Conventional Milling

Internal

FIG.1

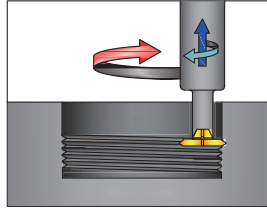

Highly Recommended

Right Hand Thread-Climb Milling

FIG.2

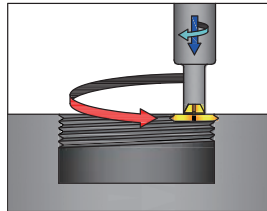

Highly Recommended

Left Hand Thread-Climb Milling

FIG.3

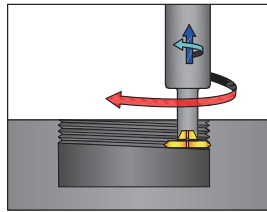

Right Hand Thread-
Conventional Milling

FIG.4

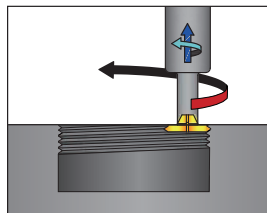

Left Hand Thread-
Conventional Milling



Internal Thread Milling Example CNC Code - Partial Profile Programm

Method 1/Tool offset-cutter compensation

- Insert code / 3T1-0612-60-1.0~2.5
- Milling / Climb milling / Internal thread
- Thread / M16x2.0P
- CNC programme / Fanuc / Mitsubishi

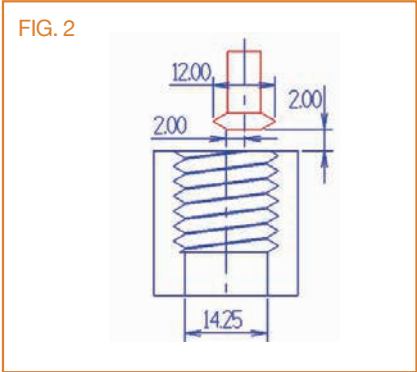
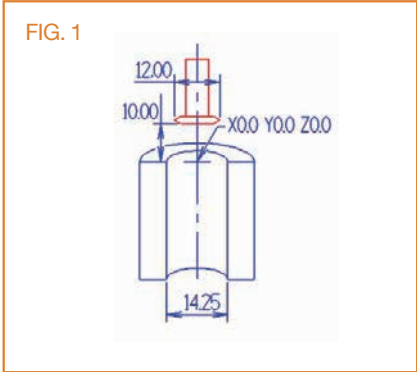

Fanuc

```

G90 G0 G54 X0.0 Y0.0
G43 Z10.0 H1 S3978 M3 (On centerline of workpiece Fig1)
M7
G00 Z1.0 (Move to the starting point Fig 2)
G01 Z-6.0 F200
G41 D? (cutter compensation)
G91 G03 X2.0 Y0.0 R2.0 F150
G03I-2.0 Z2.0 F630 (Thread milling)
G03I-2.0 Z2.0
G03I-2.0 Z2.0
G03I-2.0 Z2.0
G90 G01 X0.0 Y0.0 (Move out from workpiece,ready to retract)
G90 G00 Z50.0 M9 (Retract the tool)
G40 (Offset finish)
M30 (Programme finish, check the quality of thread, modify G41 D?figure)
    
```

Exact cutting data
see page 141-143

Internal Thread Milling Example CNC Code - Partial Profile Programm

Method 2: Reset the starting point(X) and (I)figure

- Insert code / 3T1-0612-60-1.0~2.5
- Milling / Climb milling / Internal thread
- Thread / M16x2.0P
- CNC programme / Fanuc / Mitsubishi

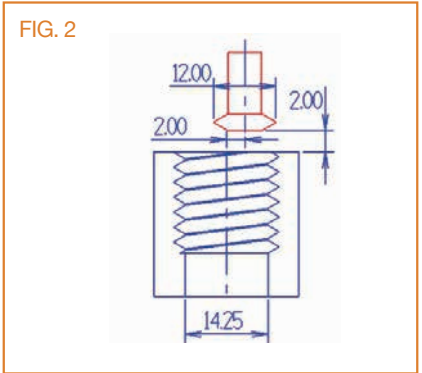
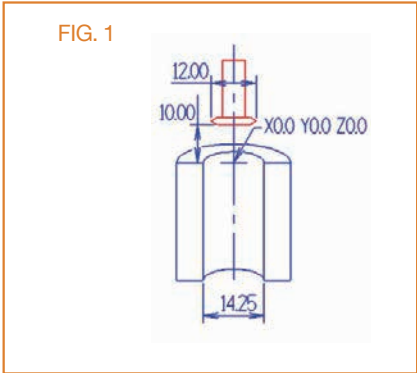

Fanuc

```

G90 G0 G54 X0.0 Y0.0
G43 Z10.0 H1 S3978 M3 (On centerline of workpiece Fig1)
M7
G00 Z1.0 (Move to the starting point Fig 2)
G01 Z-6.0 F200
G91 G03 X2.0 Y0.0 R2.0 F150
G03 I-2.0 Z2.0 F630 (Thread milling)
G03 I-2.0 Z2.0
G03 I-2.0 Z2.0
G03 I-2.0 Z2.0
G90 G01 X0.0 Y0.0 (Move out from workpiece,ready to retract)
G90 G00 Z50.0 M9 (Retract the tool)
M30 (Programme finish, check the quality of thread, modify X.I figure)
    
```

Exact cutting data
see page 141-143



External Thread Milling Example CNC Code - Partial Profile Programm

Method 1/Tool offset-cutter compensation

- Insert code / 3T1-0612-60-1.0-2.5
- Milling / Climb milling / External thread
- Thread / M16x2.0P
- CNC programme / Fanuc/Mitsubishi

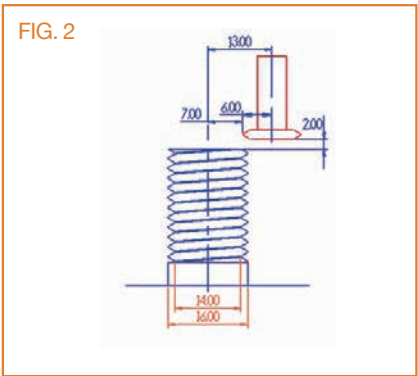
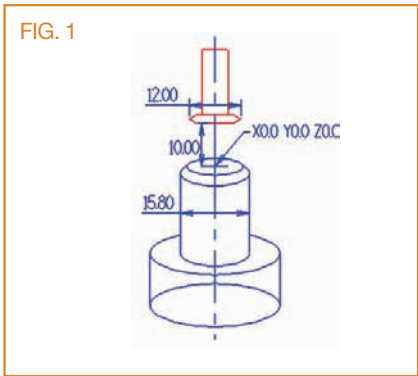

Fanuc

```

G90 G0 G54 X0.0 Y0.0
G43 Z10.0 H1 S3978 M3 (On centerline of workpiece Fig1)
M7
G00 X13.0 Y0.0 (Move to the starting point Fig 2)
G41 D? (Cutter compensation)
G01 Z2.0 F200
G91 G02I-13.0 Z-2.0 F630 (Thread milling)
G02I-13.0 Z-2.0
G02I-13.0 Z-2.0
G02I-13.0 Z-2.0
G90 G01 X16.0 (Move out from workpiece, ready to retract)
G90 G00 Z50.0 M9 (Retract the tool)
G40 (Offset finish)
M30 (Programme finish, check the quality of thread, modify G41 D? figure)
    
```

Exact cutting data
see page 141-143

External Thread Milling Example CNC Code - Partial Profile Programm

Method 2: Reset the starting point(X) and (I)figure

- Insert code / 3T1-0612-60-1.0-2.5
- Milling / Climb milling / External thread
- Thread / M16x2.0P
- CNC programme / Fanuc / Mitsubishi

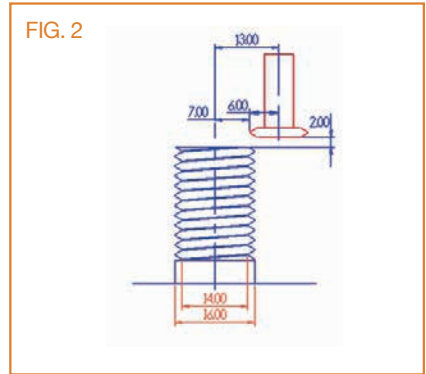
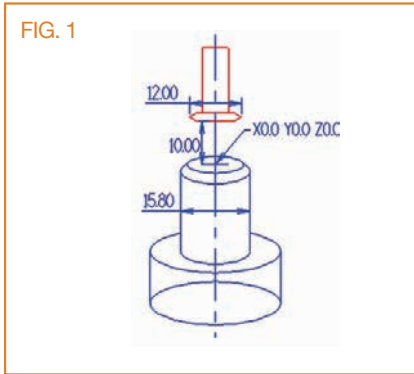

Fanuc

```
G90 G0 G54 X0.0 Y0.0
G43 Z10.0 H1 S3978 M3 (On centerline of workpiece Fig1)
M7
G00 X13.0 Y0.0 (Move to the contour starting point Fig 2)
G01 Z2.0 F200
G91 G02 I-13.0 Z-2.0 F630 (Thread milling)
G02 I-13.0 Z-2.0
G02 I-13.0 Z-2.0
G02 I-13.0 Z-2.0
G90 G01 X16.0 (Move out from workpiece,ready to retract)
G90 G00 Z50.0 M9 (Retract the tool)
M30 (Programme finish, check the quality of thread, modify X.I figure)
```

Exact cutting data
see page 141-143



Recommended Preparatory Drill Diameter And Available Inserts

Insert diameter : ● $\varnothing 12$ ● $\varnothing 15$ ● $\varnothing 20$ ● $\varnothing 25$

Size	Maximum drill diameter		
	4H	5H	6H
M1 x 0.25	0.77	0.78	0.80
M1 x 0.20	0.82	0.83	0.84
M1.1 x 0.25	0.87	0.88	0.90
M1.1 x 0.20	0.92	0.93	0.94
M1.2 x 0.25	0.97	0.98	1.00
M1.2 x 0.20	1.02	1.03	1.04
M1.4 x 0.30	1.12	1.14	1.16
M1.4 x 0.20	1.22	1.23	1.24
M1.6 x 0.35	1.28	1.30	1.32
M1.6 x 0.20	1.42	1.43	1.44
M1.7 x 0.35	1.38	1.40	1.42
M1.7 x 0.30	1.42	1.44	1.46
M1.7 x 0.25	1.47	1.48	1.50
M1.7 x 0.20	1.52	1.53	1.54
M1.8 x 0.35	1.48	1.50	1.52
M1.8 x 0.20	1.62	1.63	1.64
M2 x 0.40	1.63	1.65	1.67
M2 x 0.25	1.77	1.78	1.80
M2.2 x 0.45	1.79	1.81	1.83
M2.2 x 0.25	1.97	1.98	2.00
M2.3 x 0.40	1.93	1.95	1.97
M2.3 x 0.35	1.98	2.00	2.02
M2.3 x 0.25	2.07	2.08	2.10
M2.5 x 0.45	2.09	2.11	2.13
M2.5 x 0.35	2.18	2.20	2.22
M2.6 x 0.45	2.19	2.22	2.23
M2.6 x 0.35	2.28	2.30	2.32
M3 x 0.50	2.54	2.57	2.59
M3 x 0.35	2.68	2.70	2.72
M3.5 x 0.60	2.95	2.97	3.01
M3.5 x 0.35	3.18	3.20	3.22
M4 x 0.70	3.35	3.38	3.42
M4 x 0.50	3.54	3.57	3.59
M4.5 x 0.75	3.80	3.83	3.87
M4.5 x 0.50	4.04	4.07	4.09
M5 x 0.90	4.15	4.19	4.23
M5 x 0.80	4.25	4.29	4.33
M5 x 0.50	4.54	4.57	4.59
M5.5 x 0.90	4.65	4.69	4.73
M5.5 x 0.75	4.80	4.83	4.87
M5.5 x 0.50	5.04	5.07	5.09
M6 x 1.00	5.06	5.10	5.15
M6 x 0.75	5.30	5.33	5.37
M6 x 0.50	5.54	5.57	5.59
M7 x 1.00	6.06	6.10	6.15
M7 x 0.75	6.30	6.33	6.37
M7 x 0.50	6.54	6.57	6.59
M8 x 1.25	6.81	6.85	6.91

Size	Maximum drill diameter		
	4H	5H	6H
M8 x 1.00	7.06	7.10	7.15
M8 x 0.75	7.30	7.33	7.37
M8 x 0.50	7.54	7.57	7.59
M9 x 1.25	7.81	7.85	7.91
M9 x 1.00	8.06	8.10	8.15
M9 x 0.75	8.30	8.33	8.37
M9 x 0.50	8.54	8.57	8.59
M10 x 1.50	8.52	8.61	8.67
M10 x 1.25	8.81	8.85	8.91
M10 x 1.00	9.06	9.10	9.15
M10 x 0.75	9.30	9.33	9.37
M10 x 0.50	9.54	9.57	9.59
M11 x 1.50	9.52	9.61	9.67
M11 x 1.00	10.06	10.10	10.15
M11 x 0.75	10.30	10.33	10.37
M11 x 0.50	10.54	10.57	10.59
M12 x 1.75	10.31	10.37	10.44
M12 x 1.50	10.56	10.61	10.67
M12 x 1.25	10.81	10.85	10.91
M12 x 1.00	11.06	11.10	11.15
M12 x 0.75	11.30	11.33	11.37
M12 x 0.50	11.54	11.57	11.59
M13 x 1.75	11.31	11.37	11.44
M13 x 1.50	11.56	11.61	11.67
M13 x 1.25	11.81	11.85	11.91
M13 x 1.00	12.06	12.10	12.15
M13 x 0.75	12.03	12.33	12.37
M13 x 0.50	12.54	12.57	12.59
M14 x 2.00	12.07	12.13	12.21
M14 x 1.50	12.56	12.61	12.67
M14 x 1.25	-	-	12.91
M14 x 1.00	13.06	13.10	13.15
M14 x 0.75	13.30	13.33	13.37
M14 x 0.50	13.54	13.57	13.59
M15 x 2.00	13.07	13.13	13.21
M15 x 1.50	13.56	13.61	13.67
M15 x 1.25	13.81	13.85	13.91
M15 x 1.00 ●	14.06	14.10	14.15
M15 x 0.75	14.30	14.33	14.37
M15 x 0.50	14.54	14.57	14.59
M16 x 2.00 ●	14.07	14.13	14.21
M16 x 1.50 ●	14.56	14.61	14.67
M16 x 1.00 ●	15.06	15.10	15.15
M17 x 2.00 ●	15.07	15.13	15.21
M17 x 1.50 ●	15.56	15.61	15.67
M17 x 1.25 ●	15.81	15.85	15.91
M17 x 1.00 ●	16.06	16.10	16.15

Recommended Preparatory Drill Diameter And Available Inserts

Insert diameter : ● \varnothing 12 ● \varnothing 15 ● \varnothing 20 ● \varnothing 25

Size	Maximum drill diameter			
	4H	5H	6H	
M17 x 0.75		16.30	16.33	16.37
M17 x 0.50		16.54	16.57	16.59
M18 x 2.50	●	15.57	15.64	15.74
M18 x 2.00	●	16.07	16.13	16.21
M18 x 1.50	●	16.56	16.61	16.67
M18 x 1.00	● ●	17.06	17.10	17.15
M19 x 2.50	●	16.57	16.64	16.74
M19 x 2.00	● ●	17.07	17.13	17.21
M19 x 1.50	● ●	17.56	17.61	17.67
M19 x 1.25	● ●	17.81	17.85	17.91
M19 x 1.00	● ●	18.06	18.10	18.15
M19 x 0.75		18.30	18.33	18.37
M19 x 0.50		18.54	18.57	18.59
M20 x 2.50	● ●	17.57	17.64	17.74
M20 x 2.00	● ●	18.07	18.13	18.21
M20 x 1.50	● ●	18.56	18.61	18.67
M20 x 1.00	● ●	19.06	19.10	19.15
M21 x 2.50	● ●	18.57	18.64	18.74
M21 x 1.50	● ●	19.56	19.61	19.67
M21 x 1.00	● ●	20.06	20.10	20.15
M22 x 2.50	● ●	19.57	19.64	19.74
M22 x 2.00	● ●	20.07	20.13	20.21
M22 x 1.50	● ●	20.56	20.61	20.67
M22 x 1.00	● ●	21.06	21.10	21.15
M23 x 2.50	● ●	20.57	20.64	20.74
M23 x 2.00	● ●	21.07	21.13	21.21
M23 x 1.50	● ●	21.56	21.61	21.67
M23 x 1.00	● ● ●	22.06	22.10	22.15
M24 x 3.00	●	21.06	21.15	21.25
M24 x 2.50	● ● ●	22.07	22.13	22.21
M24 x 1.50	● ● ●	22.56	22.61	22.67
M24 x 1.00	● ● ●	23.06	23.10	23.15
M25 x 3.00	● ● ●	22.06	22.15	22.25
M25 x 2.00	● ● ●	23.07	23.13	23.21
M25 x 1.50	● ● ●	23.56	23.61	23.67
M25 x 1.00	● ● ●	24.06	24.10	24.15
M26 x 3.00	● ● ●	23.06	23.15	23.25
M26 x 2.00	● ● ●	24.07	24.13	24.21
M26 x 1.50	● ● ●	24.56	24.61	24.67
M27 x 3.00	● ● ●	24.06	24.15	24.25
M27 x 2.50	● ● ●	24.57	24.64	24.74
M27 x 2.00	● ● ●	25.07	25.13	25.21
M27 x 1.50	● ● ●	25.56	25.61	25.67
M27 x 1.00	● ● ●	26.06	26.10	26.15
M28 x 3.00	● ● ●	25.06	25.15	25.25
M28 x 2.00	● ● ●	26.07	26.13	26.21
M28 x 1.50	● ● ●	26.56	26.61	26.67

Size	Maximum drill diameter			
	4H	5H	6H	
M28 x 1.00	● ● ● ●	27.06	27.10	27.15
M30 x 3.50	●	26.56	26.66	26.77
M30 x 3.00	● ● ● ●	27.06	27.15	27.25
M30 x 2.00	● ● ● ●	28.07	28.13	28.21
M30 x 1.50	● ● ● ●	28.56	28.61	28.67
M30 x 1.00	● ● ● ●	29.06	29.10	29.15
M32 x 3.00	● ● ● ●	29.06	29.15	29.25
M32 x 2.00	● ● ● ●	30.07	30.13	30.21
M32 x 1.50	● ● ● ●	30.56	30.61	30.67
M33 x 3.50	● ● ● ●	29.56	29.66	29.77
M33 x 3.00	● ● ● ●	30.06	30.15	30.25
M33 x 2.00	● ● ● ●	31.07	31.13	31.21
M33 x 1.50	● ● ● ●	31.56	31.61	31.67
M33 x 1.00	● ● ● ●	32.06	32.10	32.15
M34 x 3.00	● ● ● ●	31.06	31.15	31.25
M34 x 2.00	● ● ● ●	32.07	32.13	32.21
M34 x 1.50	● ● ● ●	32.56	32.61	32.67
M34 x 1.00	● ● ● ●	33.06	33.10	33.15
M35 x 3.00	● ● ● ●	32.06	32.15	32.25
M35 x 1.50	● ● ● ●	33.56	33.61	33.67
M35 x 1.00	● ● ● ●	34.06	34.10	34.15
M36 x 4.00	● ● ● ●	32.04	32.14	32.27
M36 x 3.00	● ● ● ●	33.06	33.15	33.25
M36 x 2.00	● ● ● ●	34.07	34.13	34.21
M36 x 1.50	● ● ● ●	34.56	34.61	34.67
M36 x 1.00	● ● ● ●	35.06	35.10	35.15
M37 x 1.50	● ● ● ●	35.56	35.61	35.67
M37 x 1.00	● ● ● ●	36.06	36.10	36.15
M38 x 4.00	● ● ● ●	34.04	34.14	34.27
M38 x 3.00	● ● ● ●	35.06	35.15	35.25
M38 x 2.00	● ● ● ●	36.07	36.13	36.21
M38 x 1.50	● ● ● ●	36.56	36.61	36.67
M39 x 4.00	● ● ● ●	35.04	35.14	35.27
M39 x 3.00	● ● ● ●	36.06	36.15	36.25
M39 x 2.00	● ● ● ●	37.07	37.13	37.21
M39 x 1.50	● ● ● ●	37.56	37.61	37.67
M39 x 1.00	● ● ● ●	38.06	38.10	38.15
M40 x 4.00	● ● ● ●	36.04	36.14	36.27
M40 x 3.00	● ● ● ●	37.06	37.15	37.25
M40 x 2.00	● ● ● ●	38.07	38.13	38.21
M40 x 1.50	● ● ● ●	38.56	38.61	38.67
M40 x 1.00	● ● ● ●	39.06	39.10	39.15
M42 x 4.50	● ● ● ●	37.55	37.65	37.79
M42 x 4.00	● ● ● ●	38.04	38.14	38.27
M42 x 3.00	● ● ● ●	39.06	39.15	39.25
M42 x 2.00	● ● ● ●	40.07	40.13	40.21
M42 x 1.50	● ● ● ●	40.56	40.61	40.67



Recommended Preparatory Drill Diameter And Available Inserts

Insert diameter : ● Ø12 ● Ø15 ● Ø20 ● Ø25

Size	Maximum drill diameter			
	4H	5H	6H	
M45 x 4.50	●	40.55	40.65	40.79
M45 x 4.00	●	41.04	41.14	41.27
M45 x 3.00	● ● ●	42.06	42.15	42.25
M45 x 2.00	● ● ● ●	43.07	43.13	43.21
M45 x 1.50	● ● ● ● ●	43.56	43.61	43.67
M45 x 1.00	● ● ● ● ● ●	44.06	44.10	44.15
M46 x 1.50	● ● ● ● ●	44.56	44.61	44.67
M48 x 5.00	●	43.03	43.14	43.29
M48 x 4.00	●	44.04	44.14	44.27
M48 x 3.00	● ● ●	45.06	45.15	45.25
M48 x 2.00	● ● ● ●	46.07	46.13	46.21
M48 x 1.50	● ● ● ● ●	46.56	46.61	46.67
M48 x 1.00	● ● ● ● ● ●	47.06	47.10	47.15
M50 x 5.00	●	45.03	45.14	45.29
M50 x 3.00	● ● ●	47.06	47.15	47.25
M50 x 2.00	● ● ● ●	48.07	48.13	48.21
M50 x 1.50	● ● ● ● ●	48.56	48.61	48.67
M50 x 1.00	● ● ● ● ● ●	49.10	49.10	49.15
M52 x 5.00	●	47.00	47.10	47.20
M52 x 4.00	●	48.00	48.10	48.20
M52 x 3.00	● ● ●	49.00	49.10	49.20
M52 x 2.00	● ● ● ●	50.00	50.10	50.20
M52 x 1.50	● ● ● ● ●	50.50	50.60	50.60
M55 x 4.00	●	51.00	51.10	51.20
M55 x 3.00	● ● ●	52.00	52.10	52.20
M55 x 2.00	● ● ● ●	53.00	53.10	53.20
M55 x 1.50	● ● ● ● ●	53.50	53.60	53.60
M56 x 5.50		50.50	50.60	50.70
M56 x 4.00	●	52.00	52.10	52.20
M56 x 3.00	● ● ●	53.00	53.10	53.20
M56 x 2.00	● ● ● ●	54.00	54.10	54.20
M56 x 1.50	● ● ● ● ●	54.50	54.60	54.60
M58 x 4.00	●	54.00	54.10	54.20
M58 x 3.00	● ● ●	55.00	55.10	55.20
M58 x 2.00	● ● ● ●	56.00	56.10	56.20
M58 x 1.50	● ● ● ● ●	56.50	56.60	56.60
M60 x 5.50		54.50	54.60	54.70
M60 x 4.00	●	56.00	56.10	56.20
M60 x 3.00	● ● ●	57.00	57.10	57.20
M60 x 2.00	● ● ● ●	58.00	58.10	58.20
M60 x 1.50	● ● ● ● ●	58.50	58.60	58.60
M62 x 4.00	●	58.00	58.10	58.20
M62 x 3.00	● ● ●	59.00	59.10	59.20
M62 x 2.00	● ● ● ●	60.00	60.10	60.2

Size	Maximum drill diameter			
	4H	5H	6H	
M62 x 1.50	● ● ● ●	60.5	60.6	60.6
M64 x 6.00		58	58.1	58.2
M64 x 4.00	●	60	60.1	60.2
M64 x 3.00	● ● ●	61	61.1	61.2
M64 x 2.00	● ● ● ●	62	62.1	62.2
M64 x 1.50	● ● ● ● ●	62.5	62.6	62.6
M65 x 4.00	●	61	61.1	61.2
M65 x 3.00	● ● ●	62	62.1	62.2
M65 x 2.00	● ● ● ●	63	63.1	63.2
M65 x 1.50	● ● ● ● ●	63.5	63.6	63.6
M68 x 6.00		62	62.1	62.2
M68 x 4.00	●	64	64.1	64.2
M68 x 3.00	● ● ●	65	65.1	65.2
M68 x 2.00	● ● ● ●	66	66.1	66.2
M68 x 1.50	● ● ● ● ●	66.5	66.6	66.6
M70 x 6.00		64	64.1	64.3
M70 x 4.00	●	66	66.1	66.2
M70 x 3.00	● ● ●	67	67.1	67.2
M70 x 2.00	● ● ● ●	68	68.1	68.2
M72 x 6.00		66	66.1	66.3
M72 x 4.00	●	68	68.1	68.2
M72 x 3.00	● ● ●	69	69.1	69.2
M72 x 2.00	● ● ● ●	70	70.1	70.2
M75 x 4.00	●	71	71.1	71.2
M75 x 3.00	● ● ●	72	72.1	72.2
M75 x 2.00	● ● ● ●	73	73.1	73.2
M76 x 2.00	● ● ● ●	74	74.1	74.2
M80 x 6.00	● ● ● ●	74	74.1	74.3
M80 x 4.00	●	76	76.1	76.2
M80 x 3.00	● ● ●	77	77.1	77.2
M80 x 2.00	● ● ● ●	78	78.1	78.2
M85 x 6.00		79	79.1	79.3
M85 x 4.00	●	81	81.1	81.2
M85 x 3.00	● ● ●	82	82.1	82.2
M85 x 2.00	● ● ● ●	83	83.1	83.2
M90 x 6.00		84	84.1	84.3
M90 x 4.00	●	86	86.1	86.2
M90 x 2.00	● ● ● ●	88	88.1	88.2
M95 x 6.00		89	89.1	89.3
M95 x 4.00	●	91	91.1	91.2
M95 x 2.00	● ● ● ●	93	93.1	93.2
M100x 6.00		94	94.1	94.3
M100x 4.00	●	96	96.1	96.2
M100x 2.00	● ● ● ●	98	98.1	98.2

RC (BSPT)

Recommended Thread Dia / T.P.I / Minimum Bore Dia

1. Cylindrical drilling without reamer

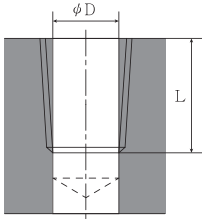

Nom. size D	P Gg/1" (tpi)	φ D	L
Rc 1/16"	28	6,15	7,85
1/8"	28	8,15	7,85
1/4"	19	10,85	11,65
3/8"	19	14,3	12,05
1/2"	14	17,8	15,9
3/4"	14	23,2	16,75
1"	11	29,2	19,65
1 1/4"	11	37,8	21,95
1 1/2"	11	43,7	21,95
2"	11	55,2	26,25

2. Cylindrical drilling with reamer to form taper thread

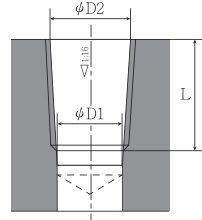

Nom. size D	P Gg/1" (tpi)	φ D1	φ D2	L
Rc 1/16"	28	6,1	6,56	7,85
1/8"	28	8,1	8,57	7,85
1/4"	19	10,75	11,45	11,65
3/8"	19	14,25	14,95	12,05
1/2"	14	17,7	18,63	15,9
3/4"	14	23,1	24,12	16,75
1"	11	29,1	30,29	19,65
1 1/4"	11	37,6	38,95	21,95
1 1/2"	11	43,5	44,85	21,95
2"	11	55	56,66	26,25

NPT

Recommended Thread Dia / T.P.I / Minimum Bore Dia

1. Cylindrical drilling without reamer

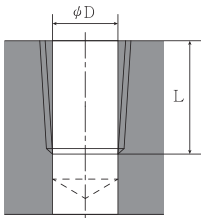

Nom. size D	P Gg/1" (tpi)	φ D	L
NPT 1/16"	27	6,15	8,3
1/8"	27	8,5	8,3
1/4"	18	11	12,15
3/8"	18	14,4	12,45
1/2"	14	17,8	16,3
3/4"	14	23,15	16,3
1"	11 1/2"	29,05	19,55
1 1/4"	11 1/2"	37,8	20,05
1 1/2"	11 1/2"	43,85	20,05
2"	11 1/2"	55,85	20,45

2. Cylindrical drilling with reamer to form taper thread

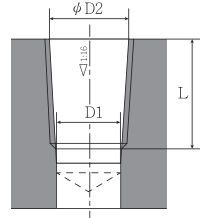

Nom. size D	P Gg/1" (tpi)	φ D1	φ D2	L
NPT 1/16"	27	5,95	6,39	8,3
1/8"	27	8,3	8,74	8,3
1/4"	18	10,75	11,36	12,15
3/8"	18	14,15	14,80	12,45
1/2"	14	17,45	18,32	16,3
3/4"	14	22,8	23,67	16,3
1"	11 1/2"	28,65	29,69	19,55
1 1/4"	11 1/2"	37,35	38,45	20,05
1 1/2"	11 1/2"	43,45	44,52	20,05
2"	11 1/2"	55,45	56,56	20,45



UFO BACK BORING



Features

Available in
materials



Cost
200~300%
SAVING

Applicable
Machines
CNC Milling machine
Drilling M/C

Efficiency
400%
UP

Durability
300%
UP

UFO
A Type
Back Boring
Cutter

UFO



UFO Family

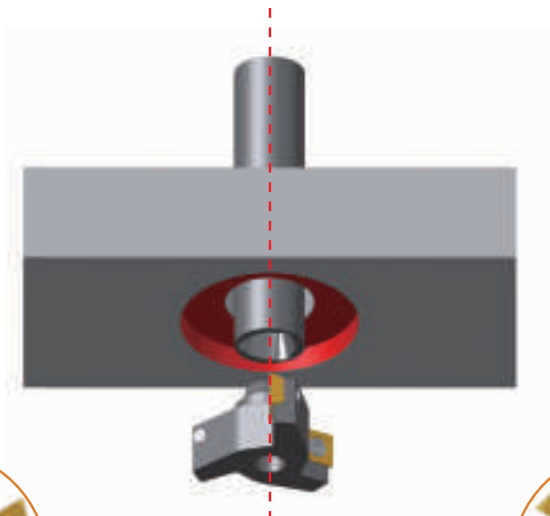

Inserts set at unequal distance from the center. Applicable with cutter $\varnothing 23$ - $\varnothing 60$ mm.



Inserts set at equal distance from the center. Applicable with cutter $\varnothing 18$ - $\varnothing 22$ mm

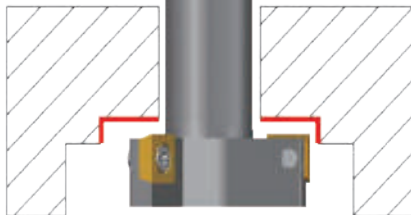

UFO
B Type
Back Boring
Cutter

UFO



1. Centerline

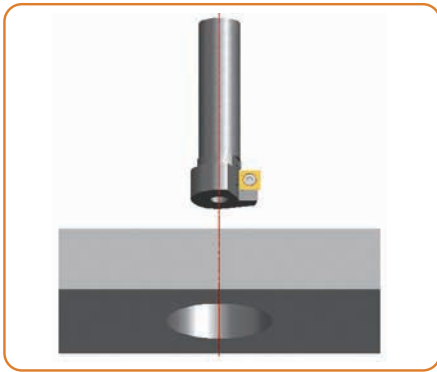

2. Tool displacement

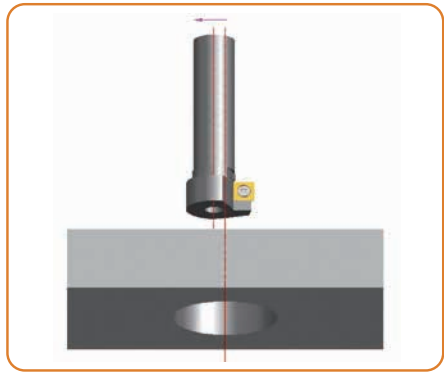

3. Machining

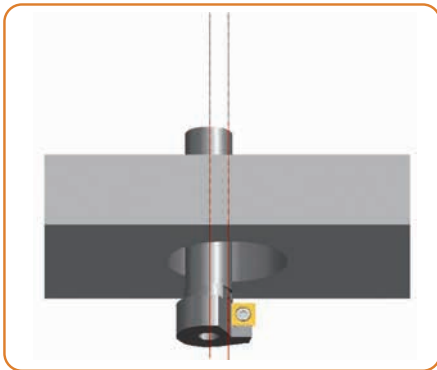

4. Back to center line

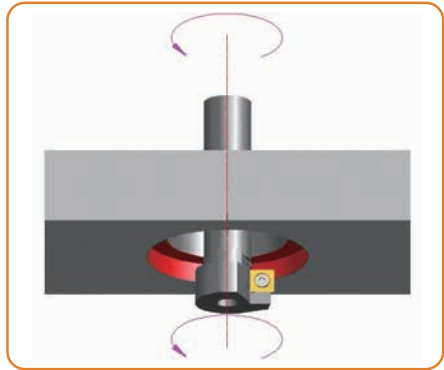

* The price and lead time are based on present conditions.

PRODUCT SPECIFICATIONS

UFO Back Boring Cutter - A Type

- Toolholders P. 26
- Insert P. 134
- Cutting Data P. 134

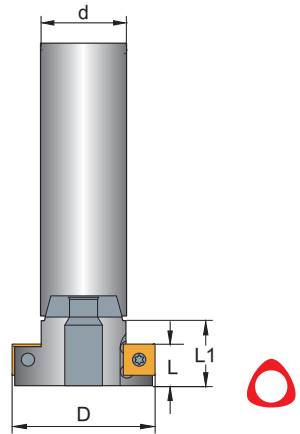

B3T

Order Code						Z	ZC	KG	MAX RPM	Inserts SDET	Screw	Key
Shank	Cutter	D	d	L	L1							
CB3-1010-80-20 CB3-1010-100-20	B3T-1018	18	10.4	9	14	2	1	0.04	14000	0602	C025045	T08P
	B3T-1018.5	18.5										
	B3T-1019	19										
	B3T-1019.5	19.5										
	B3T-1020	20				3						
	B3T-1020.5	20.5										
	B3T-1021	21										
	B3T-1021.5	21.5										
	B3T-1022	22										



UFO Back Boring Cutter - A Type

- Toolholders P. 27 - 28
- Insert P. 134
- Cutting Data P. 134

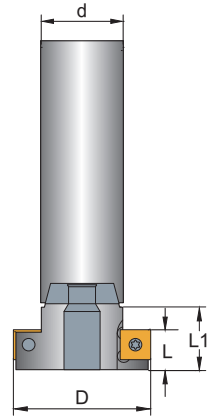

B3T

Order Code						Z	ZC	KG	MAX RPM	Inserts SDET	Screw	Key
Shank	Cutter	D	d	L	L1							
CB3-1212-90-25 CB3-1212-110-25	B3T-1223	23	12.4	9	14	3	1	0.04	13000	0602	C025045	T08P
	B3T-1224	24										
	B3T-1225	25										
	B3T-1226	26										
	B3T-1227	27						0.05				
	B3T-1228	28										
	B3T-1229	29										
	B3T-1230	30										
CB3-1616-120-30 CB3-1616-150-30	B3T-1631	31	16.4	12	17	3	1	0.06	12500	09T3	C04008	T15P
	B3T-1632	32										
	B3T-1633	33										
	B3T-1634	34										
	B3T-1635	35						0.10				
	B3T-1636	36										
	B3T-1637	37										
	B3T-1638	38										
	B3T-1639	39										
	B3T-1640	40							0.11			

UFO Back Boring Cutter - A Type

- Toolholders P. 29
- Insert P. 134
- Cutting Data P. 134

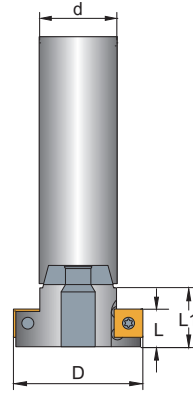

UFO Family

B3T

Order Code						Z	ZC		MAX RPM	Inserts SDET	Screw	Key
Shank	Cutter	D	d	L	L1							
CB3-2525-110 CB3-2525-170	B3T-2541	41	25.4	12	17	3	1	0.14	10000	09T3	C04008	T15P
	B3T-2542	42										
	B3T-2543	43										
	B3T-2544	44										
	B3T-2545	45										
	B3T-2546	46										
	B3T-2547	47										
	B3T-2548	48										
	B3T-2549	49										
	B3T-2550	50										
	B3T-2551	51										
	B3T-2552	52										
	B3T-2553	53										
	B3T-2554	54										
	B3T-2555	55										
	B3T-2556	56										
	B3T-2557	57										
	B3T-2558	58										
	B3T-2559	59										
	B3T-2560	60										



Recommended Insert Grades

• UFO Back Boring Cutter Insert Grade Selection

Material group	Recom. fz (mm/tooth)	Inserts		
		SDET.....ME	SDET.....E	
1	0.04-0.08	B100	-	-
2		B100	-	-
3		B100	-	-
4	0.04-0.07	B100	-	-
5		B100	-	-
6	0.04-0.06	B100	-	-
7		B100	-	-
8		B100	-	-
9	0.04-0.08	B100	-	-
10		B100	-	-
11	0.04-0.06	B100	-	-
12		B100	-	-
13	0.07-0.1	F30	-	-
14		F30	-	-
15		F30	-	-
16	0.1-0.2	-	-	-
17		-	-	-
18		-	-	-
19	0.04-0.06	B100	-	-
20	0.04-0.05	B100	-	-
21	0.03-0.04	B100	-	-
22	0.04-0.05	B100	-	-

Recommended Cutting Data - UFO Back Boring Cutter

• Recommended Cutting Speed, Vc(m/min)

Material group	Grades											
	B100	C250	F20	CE60	CE	K10	F30					
	fz (mm/tooth)											
	0.04	0.06	0.08			0.08	0.10	0.12	0.08	0.10	0.12	
Cutting speed, v _c (m/min)												
1	16	18	20	-	-	-	-	-	-	-	-	
2	16	18	20	-	-	-	-	-	-	-	-	
3	14	12	10	-	-	-	-	-	-	-	-	
4	14	12	10	-	-	-	-	-	-	-	-	
5	12	10	8	-	-	-	-	-	-	-	-	
6	12	10	8	-	-	-	-	-	-	-	-	
7	8	-	-	-	-	-	-	-	-	-	-	
8	14	12	10	-	-	-	-	-	-	-	-	
9	14	12	10	-	-	-	-	-	-	-	-	
10	12	10	8	-	-	-	-	-	-	-	-	
11	12	10	8	-	-	-	-	-	-	-	-	
12	-	-	-	-	-	-	-	-	-	40	35	30
13	-	-	-	-	-	-	-	-	-	40	35	30
14	-	-	-	s-	-	-	-	-	-	30	25	20
15	-	-	-	-	-	-	-	-	-	30	25	20
16	-	-	-	-	-	-	-	-	-	-	-	-
17	-	-	-	-	-	-	-	-	-	-	-	-
20	8	10	-	-	-	-	-	-	-	-	-	-
21	8	10	-	-	-	-	-	-	-	-	-	-
22	8	10	-	-	-	-	-	-	-	-	-	-

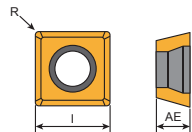

SDET Insert

Tolerances (mm)

I AE
±0.03 ±0.025



Inserts 10 PCS / Box

Code	Dimensions (mm)		
	I	AE	R
060208	6.0	2.3	0.3
09T308	9.0	3.97	0.5

Inserts	Order Code	Grades										
		Carbide					Metal cermet			Uncoated		
		B100	C200	C250	F20	F30	CE25	CE100	CE60	K10	CE	
	SDET060208N-ME	☉										
	SDET09T308TN-M	☉										
	SDET09T308TN-ME	☉										

- Steel Stainless Steel Steel/Stainless Steel/Super alloy Cast Iron Aluminum Steel/Cast Iron
- Steel/Stainless Steel/Cast Iron
- Prices and stocks are based on present conditions
- Please specify model numbers and the grade of inserts, ie.: SDET060208N-ME, B100

Recommended Insert Grades - UFO T-slot Cutter / Radius / Dual Chamfer / Dovetail / Circlip / Dual Corner Rounding



UFO Family

• Insert Grade Selection

Material group	Recom. fz (mm/tooth) AR/Dc = 10%	Grades			
		ME	E		
1	-	B100	-	-	-
2	-	B100	-	-	-
3	-	B100	-	-	-
4	-	B100	-	-	-
5	-	B100	-	-	-
6	-	B100	-	-	-
7	-	B100	-	-	-
8	-	B100	-	-	-
9	-	B100	-	-	-
10	-	B100	-	-	-
11	-	B100	-	-	-
12	-	F20	-	-	-
13	-	F20	-	-	-
14	-	F20	-	-	-
15	-	F20	-	-	-
16	-	-	K10,F20	-	-
17	-	-	K10,F20	-	-
18	-	-	-	-	-
19	-	-	-	-	-
20	-	B100	-	-	-
21	-	B100	-	-	-
22	-	B100	-	-	-

• Cutting Data

Operations	AR / Dc	Recom. fz (mm/tooth)		
Full engagement	-	0.04	0.08	0.11
Side Milling	2%	0.17	0.44	0.65
	5%	0.11	0.28	0.41
	10%	0.08	0.20	0.30
	20%	0.07	0.14	0.21
	30%	0.05	0.12	0.18
Average Chip Thickness (hm)	-	0.03	0.06	0.09



Recommended Insert Grades - UFO T-slot Cutter / Radius / Dual Chamfer / Dovetail / Circlip / Dual Corner Rounding



• Recommended Cutting Speed, V_c (m/min)

Material group	Grades						
	B100	C350	F20	CE60	CE	K10	F30
	Cutting speed, v_c (m/min)						
1	179 161 140	-	-	-	-	-	-
2	140 126 113	-	-	-	-	-	-
3	126 113 102	-	-	-	-	-	-
4	112 102 91	-	-	-	-	-	-
5	101 91 81	-	-	-	-	-	-
6	91 - -	-	-	-	-	-	-
7	40 - -	-	-	-	-	-	-
8	160 - 70	-	-	-	-	-	-
9	160 - 70	-	-	-	-	-	-
10	80 - 50	-	-	-	-	-	-
11	80 - 50	-	-	-	-	-	-
12	-	-	130 120 110	-	-	-	-
13	-	-	120 110 100	-	-	-	-
14	-	-	90 80 70	-	-	-	-
15	-	-	60 50 -	-	-	-	-
16	-	-	1150 950 850	-	-	1150 950 850	-
17	-	-	950 780 700	-	-	950 780 700	-
18	-	-	-	-	-	-	-
19	-	-	-	-	-	-	-
20	50 45 -	-	-	-	-	-	-
21	35 40 -	-	-	-	-	-	-
22	50 45 -	-	-	-	-	-	-

* Coolant is always required

• F_z (mm/tooth)

	f_z (mm/tooth)					
	Material group					
	1 2 3 4	5 6	8 9 10 11	12 13 14 15	16 17	20 21 22
0.5-0.7 mm	0.02-0.03	0.02-0.03	0.02-0.03	0.02-0.04	0.02-0.05	0.01-0.015
0.8-1.0 mm	0.02-0.03	0.02-0.03	0.02-0.03	0.02-0.04	0.02-0.05	0.01-0.02
1.1-1.3 mm	0.025-0.04	0.015-0.04	0.015-0.04	0.02-0.05	0.02-0.06	0.015-0.025
1.4-1.6 mm	0.025-0.04	0.02-0.03	0.02-0.04	0.025-0.06	0.03-0.07	0.02-0.03
1.7-2.2 mm	0.03-0.05	0.02-0.04	0.02-0.05	0.03-0.07	0.03-0.08	0.02-0.035
2.5-3.0 mm	0.03-0.05	0.03-0.045	0.03-0.05	0.03-0.08	0.04-0.10	0.025-0.04
3.5-4.0 mm	0.03-0.05	0.03-0.045	0.03-0.05	0.03-0.08	0.04-0.10	0.025-0.04
4.2-8.0 mm	0.04-0.07	0.03-0.06	0.04-0.07	0.05-0.10	0.05-0.10	0.025-0.05
6.0-8.0 mm	0.04-0.07	0.03-0.06	0.04-0.07	0.05-0.10	0.05-0.10	0.025-0.05

Recommended Insert Grades - UFO T-slot Cutter



UFO Family

• UFO T-slot Cutter Insert Grade Selection

Material group	Recom. fz (mm/tooth) AR/Dc = 10%	Grades			
		LNGT EE	LNGT M	LNGT ME	
1	0.04-0.12	-	B100	B100	-
2	0.04-0.10	-	B100	B100	-
3	0.04-0.10	-	B100	B100	-
4	0.04-0.10	-	B100	B100	-
5	0.04-0.08	-	B100	B100	-
6	0.04-0.07	-	B100	B100	-
7	0.03-0.06	-	-	B100	-
8	0.04-0.12	-	-	B100	-
9	0.04-0.10	-	-	B100	-
10	0.04-0.09	-	-	B100	-
11	0.04-0.08	-	-	B100	-
12	0.04-0.12	-	-	F20	-
13	0.04-0.12	-	-	F20	-
14	0.04-0.11	-	-	F20	-
15	0.04-0.10	-	-	F20	-
16	0.06-0.13	F20	-	-	-
17	0.06-0.12	F20	-	-	-
20	0.06-0.08	-	-	B100	-
21	0.04-0.06	-	-	B100	-
22	0.04-0.07	-	-	B100	-

• Cutting Data

Operations	AR / Dc	Recom. fz (mm/tooth)		
Full engagement	-	0.04	0.08	0.11
Side Milling	2%	0.17	0.44	0.65
	5%	0.11	0.28	0.41
	10%	0.08	0.20	0.30
	20%	0.07	0.14	0.21
	30%	0.05	0.12	0.18
Average Chip Thickness (hm)	-	0.03	0.06	0.09



Recommended Cutting Data - UFO T-slot Cutter



• Recommended Cutting Speed, Vc (m/min)

Material group	Grades						
	B100	C350	F20	CE60	CE	K10	F30
	Cutting speed, v _c (m/min)						
1	255 230 200	-	-	-	-	-	-
2	200 180 162	-	-	-	-	-	-
3	180 162 145	-	-	-	-	-	-
4	160 145 130	-	-	-	-	-	-
5	144 130 116	-	-	-	-	-	-
6	130 117 105	-	-	-	-	-	-
7	-	-	-	-	-	-	-
8	160 - 80	-	-	-	-	-	-
9	160 - 80	-	-	-	-	-	-
10	80 - 50	-	-	-	-	-	-
11	80 - 50	-	-	-	-	-	-
12	-	-	140 119 105	-	-	-	-
13	-	-	126 105 98	-	-	-	-
14	-	-	112 98 91	-	-	-	-
15	-	-	88 81 -	-	-	-	-
16	-	-	1150 950 850	-	-	-	-
17	-	-	950 780 700	-	-	-	-
20	50 45 -	-	-	-	-	-	-
21	35 40 -	-	-	-	-	-	-
22	50 45 -	-	-	-	-	-	-

• Fz (mm/tooth)

	fz (mm/tooth)											
	Material group											
	1 2 3 4	5 6	8 9 10 11	12 13 14 15	16 17	20 21 22						
1.4-1.7 mm	0.02-0.03	0.015-0.025	0.02-0.03	0.02-0.04	0.02-0.04	0.015-0.025						
1.8-2.2 mm	0.03-0.05	0.03-0.04	0.02-0.03	0.03-0.06	0.03-0.08	0.02-0.03						
2.5-3.0 mm	0.03-0.06	0.03-0.05	0.03-0.05	0.03-0.08	0.03-0.10	0.03-0.04						
3.0-3.5 mm	0.04-0.08	0.03-0.06	0.03-0.06	0.04-0.10	0.04-0.10	0.03-0.05						
4.0-4.5 mm	0.04-0.08	0.03-0.06	0.03-0.06	0.04-0.10	0.04-0.10	0.03-0.05						
5.0-5.5 mm	0.05-0.10	0.04-0.08	0.04-0.07	0.05-0.12	0.05-0.17	0.04-0.06						

Recommended Insert Grades - UFO T-slot Cutter

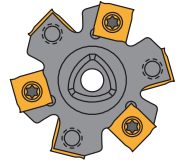

UFO Family

• UFO T-slot Cutter Insert Grade Selection

Material group	Recom. fz (mm/tooth) AR/DC=10%	Inserts			
		SNGX ... M	SNGX...ME	SNGX...EE	
1	0.14-0.30	-	B100	-	-
2	0.14-0.25	-	B100	-	-
3	0.14-0.22	-	B100	-	-
4	0.14-0.22	-	B100	-	-
5	0.14-0.20	-	B100	-	-
6	0.10-0.15	-	B100	-	-
7	0.10-0.13	-	B100	-	-
8	0.14-0.25	-	B100	-	-
9	0.14-0.22	-	B100	-	-
10	0.14-0.20	-	B100	-	-
11	0.10-0.15	-	B100	-	-
12	0.14-0.30	-	F30	-	-
13	0.14-0.22	-	F30	-	-
14	0.14-0.20	-	F30	-	-
15	0.10-0.15	-	F30	-	-
16	0.16-0.30	-	-	F20	-
17	0.16-0.25	-	-	F20	-
18	0.16-0.20	-	-	F20	-
19	0.14-0.20	-	B100	-	-
20	0.14-0.18	-	B100	-	-
21	0.10-0.13	-	B100	-	-
22	0.14-0.20	-	B100	-	-

• Cutting Data

Operations	AR / Dc	Recom. fz (mm/tooth)		
Full engagement	-	0.05	0.10	0.14
Side Milling	2%	0.21	0.44	0.65
	5%	0.14	0.28	0.41
	10%	0.10	0.20	0.30
	20%	0.07	0.14	0.21
	30%	0.06	0.12	0.18
Average Chip Thickness (hm)	-	0.03	0.06	0.09



Recommended Cutting Data - UFO T-slot Cutter



• Recommended Cutting Speed, Vc (m/min)

Material group	Grades													
	B100			C250			F20		CE60	CE	K10	F30		
	fz (mm/tooth)													
	0.1	0.2	0.3	0.1	0.2	0.3	0.1	0.2	0.3			0.1	0.2	0.3
Cutting Speed, Vc (m/min)														
1	186	166	150	-	-	-	-	-	-	-	-	-	-	-
2	168	150	135	-	-	-	-	-	-	-	-	-	-	-
3	151	136	122	-	-	-	-	-	-	-	-	-	-	-
4	136	122	110	-	-	-	-	-	-	-	-	-	-	-
5	120	110	99	-	-	-	-	-	-	-	-	-	-	-
6	92	78	-	-	-	-	-	-	-	-	-	-	-	-
7	-	-	-	-	-	-	-	-	-	-	-	-	-	-
8	160	-	80	-	-	-	-	-	-	-	-	-	-	-
9	160	-	80	-	-	-	-	-	-	-	-	-	-	-
10	80	-	50	-	-	-	-	-	-	-	-	-	-	-
11	80	-	50	-	-	-	-	-	-	-	-	-	-	-
12	-	-	-	-	-	-	-	-	-	-	-	140	119	105
13	-	-	-	-	-	-	-	-	-	-	-	126	105	98
14	-	-	-	-	-	-	-	-	-	-	-	119	98	91
15	-	-	-	-	-	-	-	-	-	-	-	91	88	-
16	-	-	-	-	-	1150	950	850	-	-	-	-	-	-
17	-	-	-	-	-	950	780	700	-	-	-	-	-	-
18	-	-	-	-	-	950	780	700	-	-	-	-	-	-
19	55	45	-	-	-	-	-	-	-	-	-	-	-	-
20	55	45	-	-	-	-	-	-	-	-	-	-	-	-
21	46	38	-	-	-	-	-	-	-	-	-	-	-	-
22	55	45	-	-	-	-	-	-	-	-	-	-	-	-

Recommended Cutting Data - Solid Carbide Thread Milling

• Recommended Cutting Speed, Vc (m/min)

Material group	Cutting Speed, Vc (m/min)		
1	255	230	200
2	200	180	162
3	180	162	145
4	160	145	130
5	144	130	116
6	130	117	105
7	40	-	-
8	160	-	80
9	160	-	80
10	80	-	50
11	80	-	50
12	136	116	102
13	122	102	95
14	109	95	88
15	85	78	-
16	1150	950	850
17	950	780	700
18	950	780	700
19	-	-	-
20	50	45	-
21	35	40	-
22	50	45	-

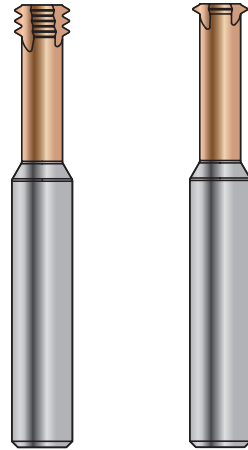

• Fz (mm/tooth)

 Pitch (mm)	fz (mm/tooth)					
	Material group					
	1 2 3 4	5 6	8 9 10 11	12 13 14 15	16 17	20 21 22
1.0-1.5	0.04-0.06	0.03-0.05	0.04-0.06	0.04-0.07	0.05-0.08	0.03-0.04
1.75-2.5	0.05-0.07	0.04-0.06	0.05-0.07	0.05-0.08	0.06-0.09	0.04-0.05
3.0-4.0	0.06-0.08	0.05-0.07	0.06-0.08	0.06-0.09	0.07-0.1	0.05-0.06
5.0-6.0	0.06-0.08	0.05-0.07	0.06-0.08	0.06-0.09	0.07-0.1	0.05-0.06



Recommended Insert Grades - UFO Thread Milling Inserts



• UFO Thread Milling Cutter Insert Grade Selection

Material group	Recom. fz (mm/tooth) AR/Dc = 10%	Grades			
		ME	E		
1	-	B100	-	-	-
2	-	B100	-	-	-
3	-	B100	-	-	-
4	-	B100	-	-	-
5	-	B100	-	-	-
6	-	B100	-	-	-
7	-	B100	-	-	-
8	-	B100	-	-	-
9	-	B100	-	-	-
10	-	B100	-	-	-
11	-	B100	-	-	-
12	-	F20	-	-	-
13	-	F20	-	-	-
14	-	F20	-	-	-
15	-	F20	-	-	-
16	-	-	F20	-	-
17	-	-	F20	-	-
18	-	-	F20	-	-
19	-	B100	-	-	-
20	-	B100	-	-	-
21	-	B100	-	-	-
22	-	B100	-	-	-

• Fz (mm/tooth)

 Pitch (mm)	fz (mm/tooth)					
	Material group					
	1 2 3 4	5 6	8 9 10 11	12 13 14 15	16 17	20 21 22
1.0-1.5	0.04-0.06	0.03-0.05	0.04-0.06	0.04-0.07	0.05-0.08	0.03-0.04
1.75-2.5	0.05-0.07	0.04-0.06	0.05-0.07	0.05-0.08	0.06-0.09	0.04-0.05
3.0-4.0	0.06-0.08	0.05-0.07	0.06-0.08	0.06-0.09	0.07-0.1	0.05-0.06
5.0-6.0	0.06-0.08	0.05-0.07	0.06-0.08	0.06-0.09	0.07-0.1	0.05-0.06

Recommended Cutting Data - UFO Thread Milling Inserts



• Recommended Cutting Speed, V_c (m/min)

Material group	Grades						
	B100	C350	F20	CE60	CE	K10	F30
	Cutting speed, v_c (m/min)						
1	179 161 140	-	-	-	-	-	-
2	140 126 113	-	-	-	-	-	-
3	126 113 102	-	-	-	-	-	-
4	112 102 91	-	-	-	-	-	-
5	101 91 81	-	-	-	-	-	-
6	91 - -	-	-	-	-	-	-
7	40 - -	-	-	-	-	-	-
8	160 - 80	-	-	-	-	-	-
9	160 - 80	-	-	-	-	-	-
10	80 - 50	-	-	-	-	-	-
11	80 - 50	-	-	-	-	-	-
12	-	-	130 120 110	-	-	-	-
13	-	-	120 110 100	-	-	-	-
14	-	-	90 80 70	-	-	-	-
15	-	-	60 50 -	-	-	-	-
16	-	-	1150 950 850	-	-	-	-
17	-	-	950 780 700	-	-	-	-
18	-	-	950 780 700	-	-	-	-
19	-	-	-	-	-	-	-
20	50 45 -	-	-	-	-	-	-
21	35 40 -	-	-	-	-	-	-
22	50 45 -	-	- - -	-	-	-	-

UFO Gear Milling Insert - Make - to - Order





UFO MILL[®]

Simple _ Speed _ Smart

Design of UFO Mill

Taper polygon + Centralizing cylinder



Taper Polygon

UFO MILL

► Taper polygon



• All grinded milling head



The UFO MILL patented taper polygon design enhances the tight fit of insert joint. It gives a better resistance to the impacts from prolonged machining and solves the cutter slippery issue. The robust tri-face contact design makes the machining stable and durable.

Tri-face contact design



Design of UFO Mill

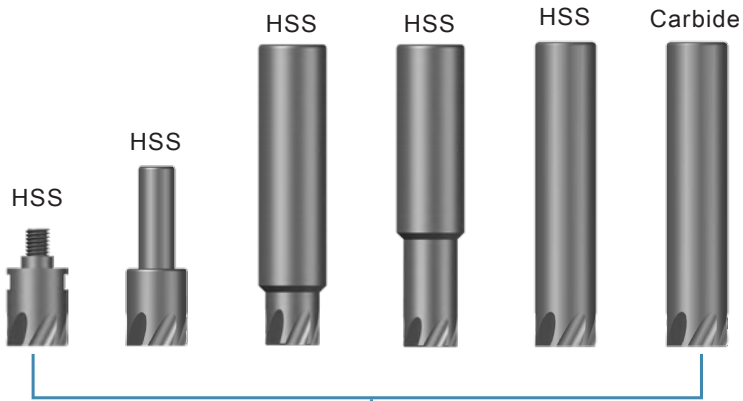

288 different carbide heads
48 different patented shanks
1938 different combinations

Square Milling Heads 3B (M/ME/E)

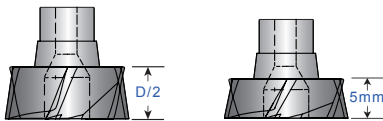

Ø10 - 25

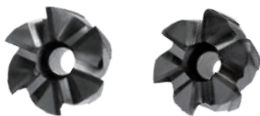

R0 / R0.5 / R1.0 / R1.5 / R2.0

High Feed Milling Heads

3BH Ø10 - 25

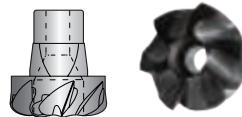

R0.6 / R0.8

High Feed Chamfer Milling Heads

3BC Ø10,13,16

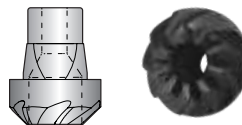

30° / 45° / 60°

Product competitive advantages

• The best cost - saving solution

• High feed design

Optional length



Step Diameter



Customized Size

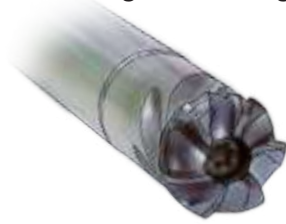

(Y.T. Design) $\varnothing 20$ - 6 flutes
Single head with multi - flutes

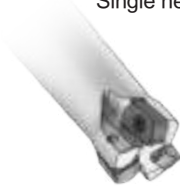

(Other brand) $\varnothing 16$ - 3 flutes

UFO MILL

Tools comparison				
Productivity ($\varnothing 16$)	6 teeth+patented geometry achieves high metal removal 😊	2-6 teeth	2-3 teeth 😞	2-6 teeth
Accuracy	Concentricity $\pm 0.005\text{mm}$ 😊		😞	
Accuracy on the corner radius	😊		😞	
Regrinding	Not necessary, less tool inventory and management cost	could be regrind but quality might not be equal	not necessary	not necessary
Tool length resetting	not necessary, can be changed directly from M/C	necessary, shrink fit arbor takes longer time to reset	re-setup is necessary in finishing process	not necessary
Price	😊	high quality end mill is very expensive	😊	😞
Flexibility	😊	😞		
Disadvantage	not economical for the user who only make side milling	1.long shank and big dia. end mill is expensive 2.poor flexibility, one size-one tool	less no. of teeth	1. expensive 2. thread breaks sometimes inside the shank



Applications of UFO Mill

Applicable industries

1 Difficult material : hardened steel / stainless steel / inconel/titanium



Aerospace parts



Mould & Die



Medical parts

2 General machining

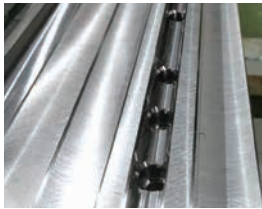

Milling



Flat surface

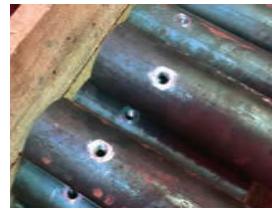

Screw hole plane

3 Casting / forging parts by mass production



Smooth finish texture by high feed machining
(Toolholders BB3 / Insert 3B 16)

4 Deep Cavity Milling

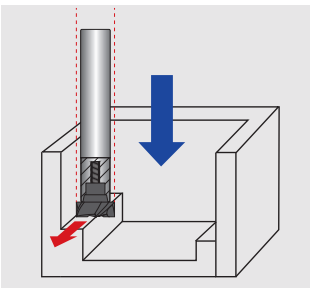

Step diameter avoids body interference

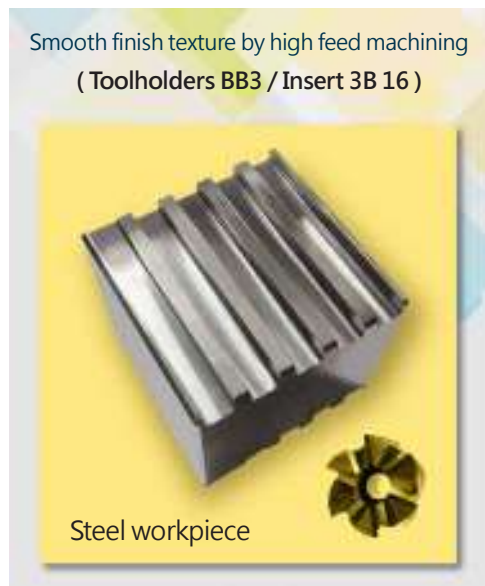

Steel workpiece

Common Holders



D:10~15

D:16~25

Taper Polygon

BB3

• HSS



Tolerances (mm)

D : $+0.0$
 $-0.01 \sim -0.02$ d : h6

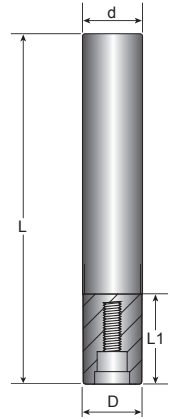

UFO MILL

Part No.	Dimensions (mm)				KG	Carbide Head	Screw	Key
	D	d	L	L1				
BB3-1010-60	9.7	10	60	18	0.11	Ø10	C03016	T09P
BB3-1010-90			90		0.13	Ø11		
BB3-1212-70	11.5	12	70		25	0.13	Ø12 Ø13	C03517
BB3-1212-100			100	0.15		Ø14 Ø15		
BB3-1414-80	13.5	14	80	24	0.14	Ø14	C04020	
BB3-1414-110			110		0.16	Ø15		
BB3-1616-80	15.5	16	80	32	0.15	Ø16		C05021
BB3-1616-110			110		0.18	Ø17		
BB3-1616-160			160		0.2	Ø18		
BB3-1818-80	17.5	18	80	30	0.16	Ø18	C05021	T20P
BB3-1818-120			120		0.18			
BB3-2020-90	19.5	20	90	38	0.17	Ø20		
BB3-2020-120			120		0.2	Ø21		
BB3-2020-180			180		0.23	Ø25		
BB3-2525-100	24.5	25	100	38	0.4	Ø25	C05021	T20P
BB3-2525-130			130		0.5			
BB3-2525-180			180		0.7			

• Not available in shrink fit arbor



Common Holders



D:10~15 D:16~25

Taper Polygon



Tolerances (mm)

D : $+0.0$
 $-0.01 \sim -0.02$
 d : h6

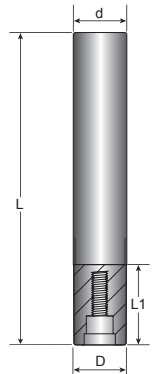

BB3W • Carbide

Part No.	Dimensions (mm)				KG	Carbide Head	Screw	Key
	D	d	L	L1				
BB3W-1010-60	9.7	10	60	20	0.20	Ø10 Ø11	C03016	T09P
BB3W-1010-90			90		0.25			
BB3W-1010-120			120		0.35			
BB3W-1212-70	11.5	12	70	22	0.26	Ø12 Ø13 Ø14 Ø15	C03517	T10P
BB3W-1212-100			100		0.30			
BB3W-1212-140			140		0.40			
BB3W-1414-80			80		0.30			
BB3W-1414-110	13.5	14	110		0.40	Ø14 Ø15		
BB3W-1616-80	15.5	16	80	26	0.40	Ø16 Ø17 Ø18	C04020	T15P
BB3W-1616-110			110		0.50			
BB3W-1616-170			170		0.70			



D:10~15 D:16~25

Taper Polygon

BB3

• HSS



Tolerances (mm)
 D : +0.0
 -0.01~-0.02 d : h6

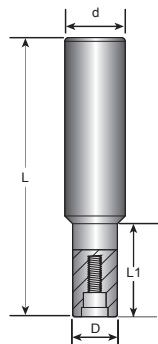

Part No.	Dimensions (mm)				KG	Carbide Head	Screw	Key
	D	d	L	L1				
BB3-1610-70	9.7	16	70	20	0.20	∅10-11	C03016	T09P
BB3-1612-80	11.5		80	25	0.25	∅12-13 ∅14-15	C03517	T10P
BB3-2014-90	13.5	20	90	28	0.50	∅14-15	C04020	T15P
BB3-2016-90	15.5			32	0.70	∅16-17 ∅18		

• Not available in shrink fit arbor



D:10~15 D:16~25

Taper Polygon

BB3

• HSS



Tolerances (mm)
 D : +0.0
 -0.01~-0.02 d : h6

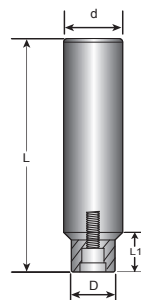

Part No.	Dimensions (mm)				KG	Carbide Head	Screw	Key
	D	d	L	L1				
BB3-1610-70S	9.7	16	70	12	0.09	∅10-11	C03016	T09P
BB3-1612-80S	11.5		80		0.12	∅12-13 ∅14-15	C03517	T10P
BB3-2014-90S	13.5	20	90		0.21	∅14-15	C04020	T15P
BB3-2016-90S	15.5					∅16-17 ∅18		
BB3-2518-90S	17.5	25	90		0.32	∅18	C05021	T20P
BB3-2520-90S	19.5					∅20-21 ∅25		
BB3-3225-100S	24.5	32	100		0.59	∅25		

• Not available in shrink fit arbor



Common Holders



D:10~15 D:16~25

Taper Polygon

BB3 · HSS



Tolerances (mm)
 D : $+0.0$
 $-0.01 \sim -0.02$ d : h6

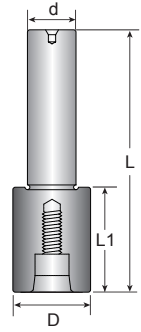

Part No.	Dimensions (mm)				KG	Carbide Head	Screw	Key
	D	d	L	L1				
BB3-1012	11.5	10	50	10	0.09	$\phi 12-13$ $\phi 14-15$	C03517	T10P
BB3-1016	15.5			12	0.10	$\phi 16-17$ $\phi 18$	C04020	T15P
BB3-1220	19.5	12		13	0.11	$\phi 20-21$ $\phi 25$	C05021	T20P
BB3-1225	24.5				0.12	$\phi 25$		

- Not available in shrink fit arbor



D:10~15 D:16~25

Taper Polygon

BB3 · HSS

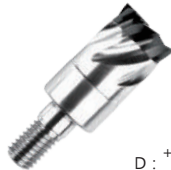

Tolerances (mm)
 D : $+0.0$
 $-0.01 \sim -0.02$

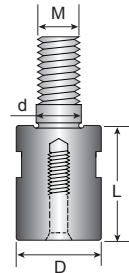

Part No.	Dimensions (mm)				KG	Carbide Head	Screw	Key	
	D	d	L	M					
BB3-10	9.7	6.5	22	6	0.05	$\phi 10$ $\phi 11$	C03016	T09P	
BB3-12	11.5		24		0.06	$\phi 12-13$ $\phi 14-15$	C03517	T10P	
BB3-16	15.5	8.5	26	8	0.08	$\phi 16-17$ $\phi 18$	C04020	T15P	
BB3-20	19.5	10.5			10	0.09	$\phi 20-21$ $\phi 25$	C05021	T20P
BB3-25	24.5	12.5			12	0.10	$\phi 25$		

- Not available in shrink fit arbor

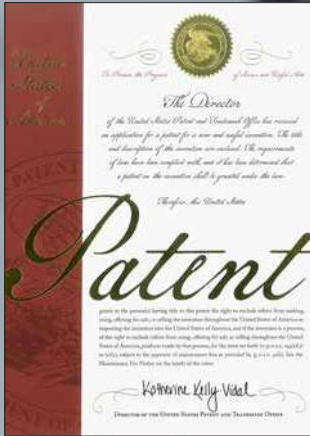

Patent pending

- | | |
|--|---|
| Taiwan invention patent (Authorized) | No. I647036 |
| Chinese invention patent (Authorized) | No. ZL 2018 1 0214725.9 |
| EPC EU invention patent (Authorized) | No. EPC EP18174847.6 |
| PCT International Patent Priority (Authorized) | International patent priority PCT/CN2019/076867 |
| Canadian patent (Authorized) | No. 3,095,794 |
| U.S. Patent (Authorized) | No.11,453,067 B2 |
| Japanese patent (Authorized) | No.77224364 |
| Korean Patent (Authorized) | No.10-2332216 |
| Indian patent | No.478339 |
| Russian patent (Authorized) | No.2749504 |

Milling Heads - M

Flute length : D/2

- Toolholders P. 149 -152
- Cutting Data P. 169 - 171



4 flutes
D:10-15mm

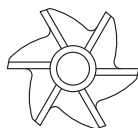

6 flutes
D:16-25mm



Taper Polygon

3B

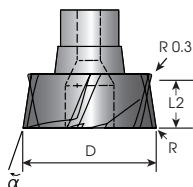

Tolerances (mm)

D : +0.0
-0.01~-0.02 L2 : ± 0.03

Dimensions (mm)			
D	L2	R	α
10	5	0	48°
		0.5	
		1	
		1.5	
		2	
11	5.5	0	
		0.5	
		1	
		1.5	
		2	
12	6	0	
		0.5	
		1	
		1.5	
		2	
13	6.5	0	
		0.5	
		1	
		1.5	
		2	

Milling Heads	Part No.	Grades										
		Carbide					Metal cermet		Uncoated			
		B100	C200	C250	F20	F30	CE25	CE60	K10		CE	
	3B1005-M	⊙										
	3B1005R0.5-M	⊙										
	3B1005R1.0-M	⊙										
	3B1005R1.5-M	⊙										
	3B1005R2.0-M	⊙										
	3B1105-M	⊙										
	3B1105R0.5-M	⊙										
	3B1105R1.0-M	⊙										
	3B1105R1.5-M	⊙										
	3B1105R2.0-M	⊙										
	3B1206-M	⊙										
	3B1206R0.5-M	⊙										
	3B1206R1.0-M	⊙										
	3B1206R1.5-M	⊙										
	3B1206R2.0-M	⊙										
	3B1306-M	⊙										
	3B1306R0.5-M	⊙										
	3B1306R1.0-M	⊙										
	3B1306R1.5-M	⊙										
	3B1306R2.0-M	⊙										

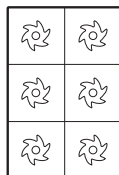

Inserts 6 PCS / Box

- ⊙ Steel / Hardened steel / Cast iron
- Ⓟ Price and stock are based on current situation
- Please specify model number and grade of insert, ie.: 3B1407R0.5-M, B100

Milling Heads - M

Flute length : D/2

- Toolholders P. 149 -152
- Cutting Data P. 169 - 171



4 flutes
D:10-15mm

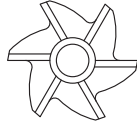

6 flutes
D:16-25mm



Taper Polygon

3B

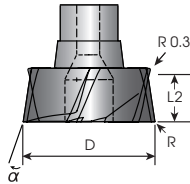

Tolerances (mm)

$$D : \begin{matrix} +0.0 \\ -0.01 \sim -0.02 \end{matrix} \quad L2 : \pm 0.03$$

Dimensions (mm)			
D	L2	R	α
14	7	0	48°
		0.5	
		1	
		1.5	
		2	
15	7.5	0	
		0.5	
		1	
		1.5	
		2	
16	8	0	
		0.5	
		1	
		1.5	
		2	
17	8.5	0	
		0.5	
		1	
		1.5	
		2	

UFO MILL

Milling Heads	Part No.	Grades									
		Carbide					Metal cermet		Uncoated		
		B100	C200	C250	F20	F30	CE2.5	CE60	K10		CE
	3B1407-M	⊙									
	3B1407R0.5-M	⊙									
	3B1407R1.0-M	⊙									
	3B1407R1.5-M	⊙									
	3B1407R2.0-M	⊙									
	3B1507-M	⊙									
	3B1507R0.5-M	⊙									
	3B1507R1.0-M	⊙									
	3B1507R1.5-M	⊙									
	3B1507R2.0-M	⊙									
	3B1608-M	⊙									
	3B1608R0.5-M	⊙									
	3B1608R1.0-M	⊙									
	3B1608R1.5-M	⊙									
	3B1608R2.0-M	⊙									
	3B1708-M	⊙									
	3B1708R0.5-M	⊙									
	3B1708R1.0-M	⊙									
	3B1708R1.5-M	⊙									
	3B1708R2.0-M	⊙									

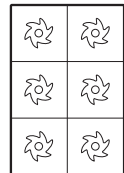

Inserts 6 PCS / Box

-  Steel / Hardened steel / Cast iron   
- Price and stock are based on current situation
- Please specify model number and grade of insert, ie.: 3B1407R0.5-M, B100



Milling Heads - M

Flute length : D/2

- Toolholders P. 149 -152
- Cutting Data P. 169 - 171



4 flutes
D:10-15mm

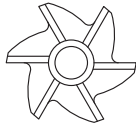

6 flutes
D:16-25mm



Taper Polygon

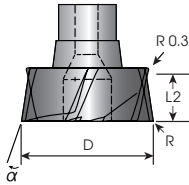

3B



Tolerances (mm)

$$D : \begin{matrix} +0.0 \\ -0.01 \end{matrix} \sim -0.02 \quad L2 : \pm 0.03$$

Dimensions (mm)			
D	L2	R	α
18	9	0	48°
		0.5	
		1	
		1.5	
		2	
20	10	0	
		0.5	
		1	
		1.5	
		2	
21	10.5	0	
		0.5	
		1	
		1.5	
		2	
25	12.5	0	
		0.5	
		1	
		1.5	
		2	

Milling Heads	Part No.	Grades										
		Carbide				Metal cermet		Uncoated				
		B100	C200	C250	F20	F30	CE25	CE60		K10	CE	
	3B1809-M	⊙										
	3B1809R0.5-M	⊙										
	3B1809R1.0-M	⊙										
	3B1809R1.5-M	⊙										
	3B1809R2.0-M	⊙										
	3B2010-M	⊙										
	3B2010R0.5-M	⊙										
	3B2010R1.0-M	⊙										
	3B2010R1.5-M	⊙										
	3B2010R2.0-M	⊙										
	3B2110-M	⊙										
	3B2110-R0.5-M	⊙										
	3B2110R1.0-M	⊙										
	3B2110R1.5-M	⊙										
	3B2110R2.0-M	⊙										
	3B2512-M	⊙										
	3B2512R0.5-M	⊙										
	3B2512R1.0-M	⊙										
	3B2512R1.5-M	⊙										
	3B2512R2.0-M	⊙										

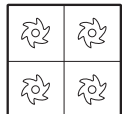

Inserts 4 PCS / Box

- ⊙ Steel / Hardened steel / Cast iron ⊕ ⊖ ⊗
- Price and stock are based on current situation
- Please specify model number and grade of insert, ie.: 3B1809R0.5-M, B100

Milling Heads - M E

Flute length : D/2

- Toolholders P. 149 -152
- Cutting Data P. 169 - 171

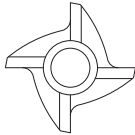

4 flutes
D:10-15mm

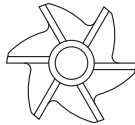

6 flutes
D:16-25mm



Taper Polygon

3B

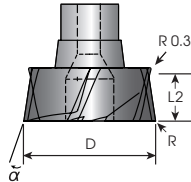

Tolerances (mm)

D : +0.0
-0.01~-0.02 L2 : ± 0.03



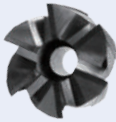

Dimensions (mm)			
D	L2	R	α
10	5	0	48°
		0.5	
		1	
		1.5	
		2	
11	5.5	0	
		0.5	
		1	
		1.5	
		2	
12	6	0	
		0.5	
		1	
		1.5	
		2	
13	6.5	0	
		0.5	
		1	
		1.5	
		2	

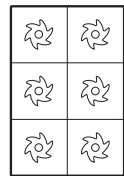
UFO MILL

Milling Heads	Part No.	Grades										
		Carbide				Metal cermet		Uncoated				
		B100	C200	C250	F20	F30	CE25	CE60	K10		CE	
	3B1005-ME	⊙										
	3B1005R0.5-ME	⊙										
	3B1005R1.0-ME	⊙										
	3B1005R1.5-ME	⊙										
	3B1005R2.0-ME	⊙										
	3B1105-ME	⊙										
	3B1105R0.5-ME	⊙										
	3B1105R1.0-ME	⊙										
	3B1105R1.5-ME	⊙										
	3B1105R2.0-ME	⊙										
	3B1206-ME	⊙										
	3B1206R0.5-ME	⊙										
	3B1206R1.0-ME	⊙										
	3B1206R1.5-ME	⊙										
	3B1206R2.0-ME	⊙										
	3B1306-ME	⊙										
	3B1306R0.5-ME	⊙										
	3B1306R1.0-ME	⊙										
	3B1306R1.5-ME	⊙										
	3B1306R2.0-ME	⊙										



Inserts 6 PCS / Box

-  Stainless steel / Titanium alloy / Cast iron    
- Price and stock are based on current situation
- Please specify model number and grade of insert, ie.: 3B1005R0.5-ME, B100



Milling Heads - M E

Flute length : D/2

- Toolholders P. 149 -152
- Cutting Data P. 169 - 171



4 flutes
D:10-15mm

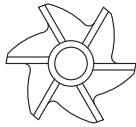

6 flutes
D:16-25mm

Dimensions (mm)			
D	L2	R	α
14	7	0	48°
		0.5	
		1	
		1.5	
		2	
15	7.5	0	
		0.5	
		1	
		1.5	
		2	
16	8	0	
		0.5	
		1	
		1.5	
		2	
17	8.5	0	
		0.5	
		1	
		1.5	
		2	



Taper Polygon

3B

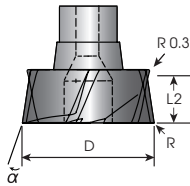

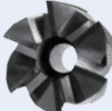

Tolerances (mm)

D : +0.0
-0.01~-0.02 L2 : ± 0.03

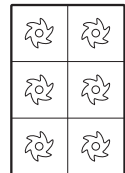
Milling Heads	Part No.	Grades									
		Carbide					Metal Cermet		Uncoated		
		B100	C200	C250	F20	F30	CE25	CE60	K10		CE
	3B1407-ME	⊙									
	3B1407R0.5-ME	⊙									
	3B1407R1.0-ME	⊙									
	3B1407R1.5-ME	⊙									
	3B1407R2.0-ME	⊙									
	3B1507-ME	⊙									
	3B1507R0.5-ME	⊙									
	3B1507R1.0-ME	⊙									
	3B1507R1.5-ME	⊙									
	3B1507R2.0-ME	⊙									
	3B1608-ME	⊙									
	3B1608R0.5-ME	⊙									
	3B1608R1.0-ME	⊙									
	3B1608R1.5-ME	⊙									
	3B1608R2.0-ME	⊙									
	3B1708-ME	⊙									
	3B1708R0.5-ME	⊙									
	3B1708R1.0-ME	⊙									
	3B1708R1.5-ME	⊙									
	3B1708R2.0-ME	⊙									



Inserts 6 PCS / Box

-  Stainless steel / Titanium alloy / Cast iron 
- Price and stock are based on current situation
- Please specify model number and grade of insert, ie.: 3B1407R0.5-ME, B100

Milling Heads - M E

Flute length : D/2

- Toolholders P. 149 -152
- Cutting Data P. 169 - 171



4 flutes
D:10-15mm

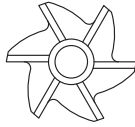

6 flutes
D:16-25mm

Dimensions (mm)			
D	L2	R	α
18	9	0	48°
		0.5	
		1	
		1.5	
		2	
20	10	0	
		0.5	
		1	
		1.5	
		2	
21	10.5	0	
		0.5	
		1	
		1.5	
		2	
25	12.5	0	
		0.5	
		1	
		1.5	
		2	



Taper Polygon

3B

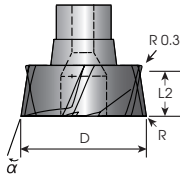

Tolerances (mm)

D : $+0.0$
 $-0.01 \sim -0.02$ L2 : ± 0.03

Milling Heads	Part No.	Grades											
		Carbide				Metal cermet		Uncoated					
		B100	C200	C250	F20	F30	CE25	CE60	K10		CE		
	3B1809-ME	⊙											
	3B1809R0.5-ME	⊙											
	3B1809R1.0-ME	⊙											
	3B1809R1.5-ME	⊙											
	3B1809R2.0-ME	⊙											
	3B2010-ME	⊙											
	3B2010R0.5-ME	⊙											
	3B2010R1.0-ME	⊙											
	3B2010R1.5-ME	⊙											
	3B2010R2.0-ME	⊙											
	3B2110-ME	⊙											
	3B2110R0.5-ME	⊙											
	3B2110R1.0-ME	⊙											
	3B2110R1.5-ME	⊙											
	3B2110R2.0-ME	⊙											
	3B2512-ME	⊙											
	3B2512R0.5-ME	⊙											
	3B2512R1.0-ME	⊙											
3B2512R1.5-ME	⊙												
3B2512R2.0-ME	⊙												

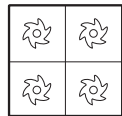

Inserts 4 PCS / Box

- ⊙ Stainless steel / Titanium alloy / Cast iron (M) (S) (K)
- Price and stock are based on current situation
- Please specify model number and grade of insert, ie.: 3B1809R0.5-ME, B100



Milling Heads - E

Flute length : D/2

- Toolholders P. 149 -152
- Cutting Data P. 169 - 171



4 flutes
D:10-15mm

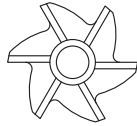

6 flutes
D:16-25mm

Dimensions (mm)			
D	L2	R	α
10	5	0	48°
		0.5	
		1	
		1.5	
		2	
11	5.5	0	
		0.5	
		1	
		1.5	
		2	
12	6	0	
		0.5	
		1	
		1.5	
		2	
13	6.5	0	
		0.5	
		1	
		1.5	
		2	



Taper Polygon

3B

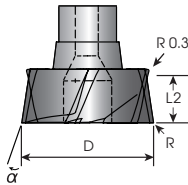

Tolerances (mm)

$$D : \begin{matrix} +0.0 \\ -0.01 \sim -0.02 \end{matrix} \quad L2 : \pm 0.03$$

Milling Heads	Part No.	Grades										
		Carbide					Metal cermet		Uncoated			
		B100	C200	C250	F20	F30	CE25	CE60	K10	CE		
	3B1005-E											
	3B1005R0.5-E											
	3B1005R1.0-E											
	3B1005R1.5-E											
	3B1005R2.0-E											
	3B1105-E											
	3B1105R0.5-E											
	3B1105R1.0-E											
	3B1105R1.5-E											
	3B1105R2.0-E											
	3B1206-E											
	3B1206R0.5-E											
	3B1206R1.0-E											
	3B1206R1.5-E											
	3B1206R2.0-E											
	3B1306-E											
	3B1306R0.5-E											
	3B1306R1.0-E											
	3B1306R1.5-E											
	3B1306R2.0-E											

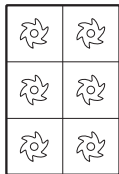

Inserts 6 PCS / Box

- Aluminum / Copper
- Price and stock are based on current situation
- Please specify model number and grade of insert, ie.: 3B1005R0.5-E, K10

Milling Heads - E

Flute length : D/2

- Toolholders P. 149 -152
- Cutting Data P. 169 - 171



4 flutes
D:10-15mm

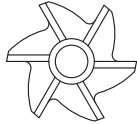

6 flutes
D:16-25mm

Dimensions (mm)			
D	L2	R	α
14	7	0	48°
		0.5	
		1	
		1.5	
		2	
15	7.5	0	
		0.5	
		1	
		1.5	
		2	
16	8	0	
		0.5	
		1	
		1.5	
		2	
17	8.5	0	
		0.5	
		1	
		1.5	
		2	



Taper Polygon

3B

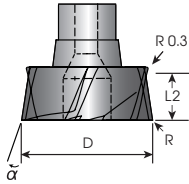

Tolerances (mm)

D : $+0.0$
 $-0.01 \sim -0.02$ L2 : ± 0.03

Milling Heads	Part No.	Grades									E	
		Carbide					Metal cermet		Uncoated			
		B100	C200	C250	F20	F30	CE2.5	CE60	K10	CE		
	3B1407-E											
	3B1407R0.5-E											
	3B1407R1.0-E											
	3B1407R1.5-E											
	3B1407R2.0-E											
	3B1507-E											
	3B1507R0.5-E											
	3B1507R1.0-E											
	3B1507R1.5-E											
	3B1507R2.0-E											
	3B1608-E											
	3B1608R0.5-E											
	3B1608R1.0-E											
	3B1608R1.5-E											
	3B1608R2.0-E											
	3B1708-E											
	3B1708R0.5-E											
	3B1708R1.0-E											
	3B1708R1.5-E											
	3B1708R2.0-E											

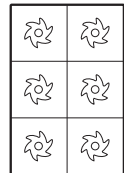

Inserts 6 PCS / Box

- Aluminum / Copper
- Price and stock are based on current situation
- Please specify model number and grade of insert, ie.: 3B1407R0.5-E, K10



Milling Heads - E

Flute length : D/2

- Toolholders P. 149 -152
- Cutting Data P. 169 - 171



6 flutes
D:16-25mm



Taper Polygon

3B

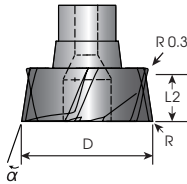

Tolerances (mm)

D : +0.0
-0.01~-0.02 L2 : ± 0.03

Dimensions (mm)			
D	L2	R	α
18	9	0	48°
		0.5	
		1	
		1.5	
		2	
		0	
20	10	0.5	
		1	
		1.5	
		2	
		0	
		0.5	
21	10.5	1	
		1.5	
		2	
		0	
		0.5	
		1	
25	12.5	1.5	
		2	
		0	
		0.5	
		1	
		1.5	

Milling Heads	Part No.	Grades									
		Carbide					Metal cermet		Uncoated		
		B100	C200	C250	F20	F30	CE25	CE60	K10		CE
	3B1809-E										
	3B1809R0.5-E										
	3B1809R1.0-E										
	3B1809R1.5-E										
	3B1809R2.0-E										
	3B2010-E										
	3B2010R0.5-E										
	3B2010R1.0-E										
	3B2010R1.5-E										
	3B2010R2.0-E										
	3B2110-E										
	3B2110R0.5-E										
	3B2110R1.0-E										
	3B2110R1.5-E										
	3B2110R2.0-E										
	3B2512-E										
	3B2512R0.5-E										
	3B2512R1.0-E										
	3B2512R1.5-E										
	3B2512R2.0-E										

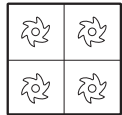

Inserts 4 PCS / Box

- Aluminum / Copper 
- Price and stock are based on current situation
- Please specify model number and grade of insert, ie.: 3B1809R0.5-E, K10

Milling Heads - M

Flute length : 5mm

- Toolholders P. 149 -152
- Cutting Data P. 169 - 171

Dimensions (mm)			
D	L2	R	α
16	5	0	48°
		0.5	
		1	
		1.5	
		2	
17	5	0	
		0.5	
		1	
		1.5	
		2	

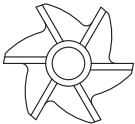

6 flutes
D:16-25mm



Taper Polygon

3B

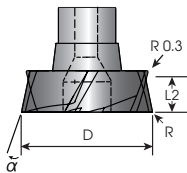

Tolerances (mm)

$$D: \begin{matrix} +0.0 \\ -0.01 \sim -0.02 \end{matrix} \quad L2: \pm 0.03$$

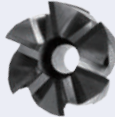
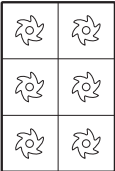
Milling Heads	Part No.	Grades										
		Carbide					Metal cermet		Uncoated			
		B100	C200	C250	F20	F30	CE25	CE60	K10	CE		
	3B1605-M	⊙										
	3B1605R0.5-M	⊙										
	3B1605R1.0-M	⊙										
	3B1605R1.5-M	⊙										
	3B1605R2.0-M	⊙										
	3B1705-M	⊙										
	3B1705R0.5-M	⊙										
	3B1705R1.0-M	⊙										
	3B1705R1.5-M	⊙										
	3B1705R2.0-M	⊙										

Inserts 6 PCS / Box

-  Steel /  Hardened steel /  Cast iron   
- Price and stock are based on current situation
- Please specify model number and grade of insert, ie.: 3B1605R0.5-M,B100



Milling Heads - M

Flute length : 5mm

- Toolholders P. 149 -152
- Cutting Data P. 169 - 171

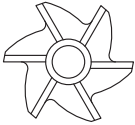

6 flutes
D:16-25mm



Taper Polygon

3B

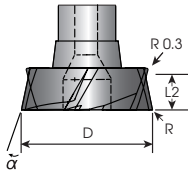

Dimensions (mm)			
D	L2	R	α
18	5	0	48°
		0.5	
		1	
		1.5	
		2	
		0	
20	5	0.5	
		1	
		1.5	
		2	
		0	
		0.5	
21	5	1	
		1.5	
		2	
		0	
		0.5	
		1	
25	5	1.5	
		2	
		0	
		0.5	
		1	
		2	

Tolerances (mm)

$$D : \begin{matrix} +0.0 \\ -0.01 \sim -0.02 \end{matrix} \quad L2 : \pm 0.03$$

Milling Heads	Part No.	Grades									
		Carbide					Metal cermet		Uncoated		
		B100	C200	C250	F20	F30	CE25	CE60	K10		CE
	3B1805-M	Ⓞ									
	3B1805R0.5-M	Ⓞ									
	3B1805R1.0-M	Ⓞ									
	3B1805R1.5-M	Ⓞ									
	3B1805R2.0-M	Ⓞ									
	3B2005-M	Ⓞ									
	3B2005R0.5-M	Ⓞ									
	3B2005R1.0-M	Ⓞ									
	3B2005R1.5-M	Ⓞ									
	3B2005R2.0-M	Ⓞ									
	3B2105-M	Ⓞ									
	3B2105R0.5-M	Ⓞ									
	3B2105R1.0-M	Ⓞ									
	3B2105R1.5-M	Ⓞ									
	3B2105R2.0-M	Ⓞ									
	3B2505-M	Ⓞ									
	3B2505R0.5-M	Ⓞ									
	3B2505R1.0-M	Ⓞ									
	3B2505R1.5-M	Ⓞ									
	3B2505R2.0-M	Ⓞ									

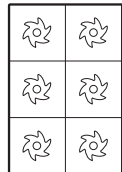

Inserts 6 PCS / Box

- Steel / Hardened steel / Cast iron
- Price and stock are based on current situation
- Please specify model number and grade of insert, i.e.: 3B1805R0.5-M,B100

Milling Heads - M E

Flute length : 5mm

- Toolholders P. 149 -152
- Cutting Data P. 169 - 171

Dimensions (mm)			
D	L2	R	α
16	5	0	48°
		0.5	
		1	
		1.5	
		2	
17	5	0	
		0.5	
		1	
		1.5	
		2	

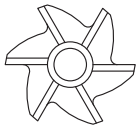

6 flutes
D:16-25mm



Taper Polygon

3B

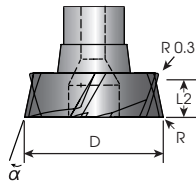

Tolerances (mm)

$$D : \begin{matrix} +0.0 \\ -0.01 \sim -0.02 \end{matrix} \quad L2 : \pm 0.03$$

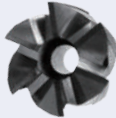
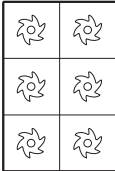
Milling Heads	Part No.	Grades									
		Carbide					Metal cermet		Uncoated		
		B100	C200	C250	F20	F30	CE25	CE60	K10		CE
	3B1605-ME	⊙									
	3B1605R0.5-ME	⊙									
	3B1605R1.0-ME	⊙									
	3B1605R1.5-ME	⊙									
	3B1605R2.0-ME	⊙									
	3B1705-ME	⊙									
	3B1705R0.5-ME	⊙									
	3B1705R1.0-ME	⊙									
	3B1705R1.5-ME	⊙									
	3B1705R2.0-ME	⊙									

Inserts 6 PCS / Box

-  Stainless steel / Titanium alloy / Cast iron
- Price and stock are based on current situation
- Please specify model number and grade of insert, i.e.: 3B1605R0.5-ME, B100



Milling Heads - M E

Flute length : 5mm

- Toolholders P. 149 -152
- Cutting Data P. 169 - 171

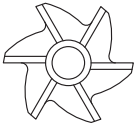

6 flutes
D:16-25mm



Taper Polygon

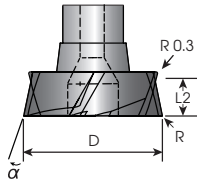

3B



Tolerances (mm)



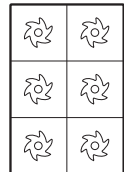

$$D : \begin{matrix} +0.0 \\ -0.01 \sim -0.02 \end{matrix} \quad L2 : \pm 0.03$$

Dimensions (mm)			
D	L2	R	α
18	5	0	48°
		0.5	
		1	
		1.5	
		2	
		0	
20	5	0.5	
		1	
		1.5	
		2	
		0	
		0.5	
21	5	1	
		1.5	
		2	
		0	
		0.5	
		1	
25	5	1.5	
		2	
		0	
		0.5	
		1	
		1.5	

Milling Heads	Part No.	Grades										
		Carbide					Metal cermet		Uncoated			
		B100	C200	C250	F20	F30	CE25	CE60	K10		CE	
	3B1805-ME	⊙										
	3B1805R0.5-ME	⊙										
	3B1805R1.0-ME	⊙										
	3B1805R1.5-ME	⊙										
	3B1805R2.0-ME	⊙										
	3B2005-ME	⊙										
	3B2005R0.5-ME	⊙										
	3B2005R1.0-ME	⊙										
	3B2005R1.5-ME	⊙										
	3B2005R2.0-ME	⊙										
	3B2105-ME	⊙										
	3B2105R0.5-ME	⊙										
	3B2105R1.0-ME	⊙										
	3B2105R1.5-ME	⊙										
	3B2105R2.0-ME	⊙										
	3B2505-ME	⊙										
	3B2505R0.5-ME	⊙										
	3B2505R1.0-ME	⊙										
3B2505R1.5-ME	⊙											
3B2505R2.0-ME	⊙											



Inserts 6 PCS / Box

-  Stainless steel / Titanium alloy / Cast iron    
- Price and stock are based on current situation
- Please specify model number and grade of insert, ie.: 3B1805R0.5-ME, B100

Milling Heads - E

Flute length : 5mm

- Toolholders P. 149 -152
- Cutting Data P. 169 - 171

Dimensions (mm)			
D	L2	R	α
16	5	0	48°
		0.5	
		1	
		1.5	
		2	
17	5	0	
		0.5	
		1	
		1.5	
		2	

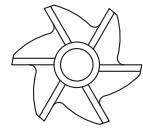

6 flutes
D:16-25mm



Taper Polygon

3B

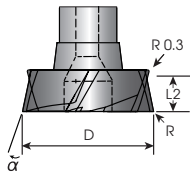

Tolerances (mm)

D : +0.0
- 0.01~-0.02 L2 : ± 0.03

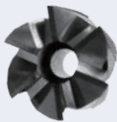
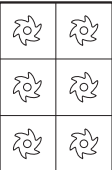
Milling Heads	Part No.	Grades										
		Carbide					Metal cermet		Uncoated			
		B100	C200	C250	F20	F30	CE25	CE60	K10		CE	
	3B1605-E											
	3B1605R0.5-E											
	3B1605R1.0-E											
	3B1605R1.5-E											
	3B1605R2.0-E											
	3B1705-E											
	3B1705R0.5-E											
	3B1705R1.0-E											
	3B1705R1.5-E											
	3B1705R2.0-E											

Inserts 6 PCS / Box

- Aluminum / Copper M
- Price and stock are based on current situation
- Please specify model number and grade of insert, ie.: 3B1605R0.5-E, K10



Milling Heads - E

Flute length : 5mm

- Toolholders P. 149 -152
- Cutting Data P. 169 - 171

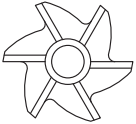

6 flutes
D:16-25mm



Taper Polygon

3B

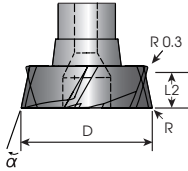

Tolerances (mm)



D : +0.0
-0.01~-0.02 L2 : ± 0.03

Dimensions (mm)			
D	L2	R	α
18	5	0	48°
		0.5	
		1	
		1.5	
		2	
20	5	0	
		0.5	
		1	
		1.5	
		2	
21	5	0	
		0.5	
		1	
		1.5	
		2	
25	5	0	
		0.5	
		1	
		1.5	
		2	

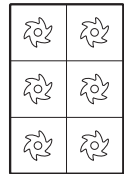
Milling Heads	Part No.	Grades									
		Carbide					Metal cermet		Uncoated		
		B100	C200	C250	F20	F30	CE25	CE60	K10		CE
	3B1805-E										
	3B1805R0.5-E										
	3B1805R1.0-E										
	3B1805R1.5-E										
	3B1805R2.0-E										
	3B2005-E										
	3B2005R0.5-E										
	3B2005R1.0-E										
	3B2005R1.5-E										
	3B2005R2.0-E										
	3B2105-E										
	3B2105R0.5-E										
	3B2105R1.0-E										
	3B2105R1.5-E										
	3B2105R2.0-E										
	3B2505-E										
	3B2505R0.5-E										
	3B2505R1.0-E										
	3B2505R1.5-E										
	3B2505R2.0-E										



Inserts 6 PCS / Box

-  Aluminum / Copper 
- Price and stock are based on current situation
- Please specify model number and grade of insert, ie.: 3B1805R0.5-E, K10

Cutting Parameter **3B-M**

Applicable to Steel / Hardened steel / Cast iron

- Keep $Fz \geq 0.03\text{mm}$

3B-M	Materials	D	Z	Vc	fz	ap	ae	S	F
		(mm)		(m/min)	(mm/tooth)	(mm)	(mm)	(rev/min)	(mm/min)
	Steel 24-32 HRC 	10	4	140	0.035	2	7	4500	630
		12	4	180	0.06	2	8	4850	1160
		16	6	180	0.06	2	11	3600	1300
		20	6	180	0.07	2	14	2900	1200
		25	6	180	0.07	2	17	2300	960
	Steel 32-42 HRC 	10	4	100	0.035	2	7	3200	450
		12	4	150	0.05	2	8	4000	800
		16	6	150	0.06	2	11	3000	1080
		20	6	150	0.06	2	14	2400	840
		25	6	150	0.06	2	17	1900	680
	Hardened steel 50-58 HRC 	10	4	70	0.06	0.1	7	2250	540
		12	4	70	0.06	0.1	8	1840	440
		16	6	70	0.06	0.1	11	1370	490
		20	6	70	0.06	0.1	14	1130	400
		25	6	70	0.06	0.1	17	890	320
	Cast Iron 	10	4	75	0.08	4	7	2400	770
		12	4	75	0.1	4	8	2000	800
		16	6	75	0.1	4	11	1550	930
		20	6	75	0.1	4	14	1200	720
		25	6	75	0.1	4	17	950	570

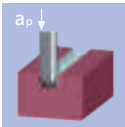

- Set RPM 30% lower for slot milling, except for cast iron materials.





UFO MILL

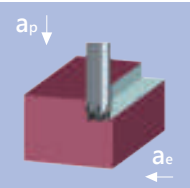

Cutting Parameter **3B-ME**

Applicable to Stainless steel / Titanium alloy / Cast iron

• Keep $Fz \geq 0.025\text{mm}$

3B-ME	Materials	D (mm)	Z	Vc (m/min)	f_z (mm/tooth)	a_p (mm)	a_e (mm)	S (rev/min)	F (mm/min)
	Stainless steel 	10	4	55	0.04	2	7	1770	283
		12	4	75	0.06	2	8	1950	468
		16	6	75	0.07	2	11	1500	630
		20	6	75	0.07	2	14	1200	500
		25	6	75	0.07	2	17	960	400
	Titanium alloy 	10	4	45	0.06	1.5	7	1450	350
		12	4	45	0.06	1.5	8	1180	280
		16	6	45	0.07	1.5	11	900	380
		20	6	45	0.07	1.5	14	720	300
		25	6	45	0.07	1.5	17	570	235
	Cast iron 	10	4	75	0.08	4	7	2400	770
		12	4	75	0.1	4	8	2000	800
		16	6	75	0.1	4	11	1550	930
		20	6	75	0.1	4	14	1200	720
		25	6	75	0.1	4	17	950	570

Cutting Parameter 3B-E

Applicable to Aluminum / Copper

3B-E	Materials	D (mm)	Z	Vc (m/min)	fz (mm/tooth)	a _p (mm)	a _e (mm)	S (rev/min)	F (mm/min)
	Aluminum	10	4	800	0.13	4	7	25800	13400
		12	4	800	0.13	4	8	21000	10900
		16	6	800	0.16	4	11	16000	15300
		20	6	800	0.16	4	14	13000	12500
		25	6	800	0.16	4	17	10000	9600
	Copper	10	4	280	0.10	4	7	9000	3600
		12	4	280	0.10	4	8	7500	3000
		16	6	280	0.10	4	11	5700	3400
		20	6	280	0.10	4	14	4500	2700
		25	6	280	0.10	4	17	3600	2160

UFO MILL

3B-E	Materials	D (mm)	Z	Vc (m/min)	fz (mm/tooth)	a _p (mm)	a _e (mm)	S (rev/min)	F (mm/min)
	Aluminum	10	4	700	0.12	4	10	22500	10800
		12	4	700	0.12	4	12	18500	8880
		16	6	700	0.15	4	16	14000	12600
		20	6	700	0.15	4	20	11000	9900
		25	6	700	0.15	4	25	9000	8100
	Copper	10	4	250	0.08	2.5	10	8000	2500
		12	4	250	0.08	2.5	12	6700	2150
		16	6	250	0.08	2.5	16	5100	2400
		20	6	250	0.08	2.5	20	4000	1900
		25	6	250	0.08	2.5	25	3160	1500

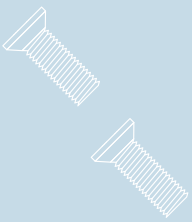

Screw & Key & Torque Values

Screw Code	Key Code	Torque Value(Nm)
C03016	T9P	2.0
C03517	T10P	3.0
C04020	T15P	4.0
C05021	T20P	6.0

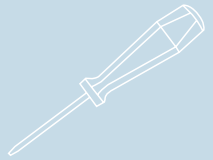



UFO High-Feed Cutter

Cutting force vs. Tool life

The direction of cutting force influences directly and significantly on the machining life and efficiency. The following are three different types of cutting force commonly seen in milling cutters:

(Cutter 1) Radial force = Axial force

There are limitations inherent in milling cutters designed with round insert; to apply it on deep A_p milling or a cavity corner milling, the radial force is nearly same as the axial force, it produces great vibrations and performs in low feed. The next, round inserts take up big space and cause the cutter carries lesser flutes.

(Cutter 2) Radial force > Axial force

The carbide end mill cutter which is mostly used for finishing and semi-finishing machining. The large helix angle satisfies small cutting area and surface roughness. However, it is not cost-effective to have it removing a large amount of materials.

(Cutter 3) Radial force < Axial force

Y.T. high-feed UFO milling cutter has unique design of curvature and point contact, it is effective in keeping the radial force lesser than axial force.

The cutting force is transferred to the spindle, it brings machining process in stable conditions and carries out a high removal rate.

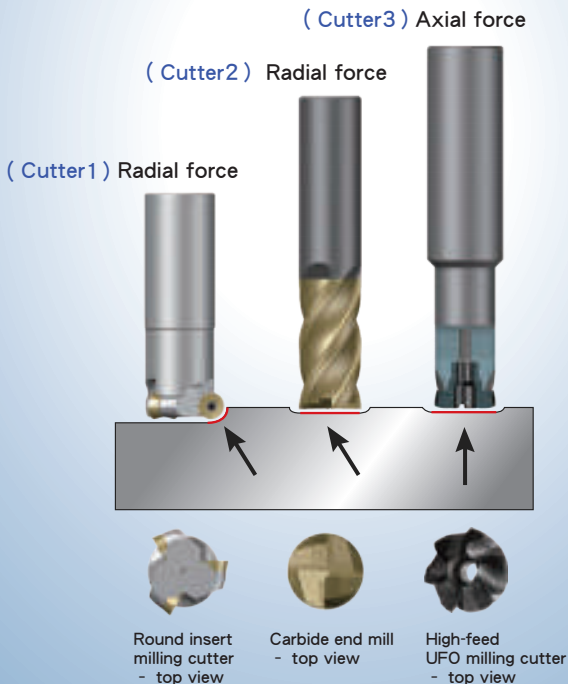

High Feed Milling Heads - 3BH

- Toolholders P. 149 -152
- Cutting Data P. 174

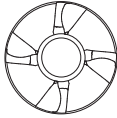

4 flutes
D: 10-11mm

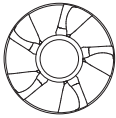

5 flutes
D: 12-13mm

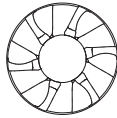

6 flutes
D: 16-25mm



3BH

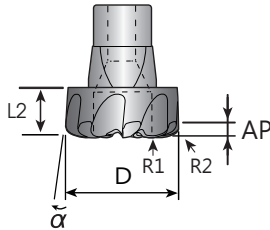

Tolerances (mm)
D : +0.0
-0.01~-0.02 L2 : ± 0.03

Dimensions (mm)					
D	L2	R1	R2	AP	α
10	5	4	0.6	0.8	3°
11					
12		5	0.8	0.9	
13					
16					
17		6	0.8	1.2	
20					
21		8	0.8	1.2	
25					

- \varnothing 10-11 Maximum AP 0.3mm
- \varnothing 12-13 Maximum AP 0.4mm
- \varnothing 16-25 Maximum AP 0.6mm

UFO MILL

Milling Heads	Part No.	Grades										
		Carbide					Metal cermet		Uncoated			
		B100	C200	C250	F20	F30	CE25	CE60	K10		CE	
	3BH1005-M	⊙										
	3BH1105-M	⊙										
	3BH1205-M	⊙										
	3BH1305-M	⊙										
	3BH1605-M	⊙										
	3BH1705-M	⊙										
	3BH2005-M	⊙										
	3BH2105-M	⊙										
	3BH2505-M	⊙										

Inserts 6 PCS / Box

- Steel / Stainless steel / Titanium alloy
- Correct price and stock are based on current situation
- Please specify model number and grade of insert, ie.: 3BH1005-M, B100



Cutting Parameter - 3BH

• Keep $Fz \geq 0.02\text{mm}$

3BH	Materials	D (mm)	Z	Vc (m/min)	f_z (mm/tooth)	a_p (mm)	a_e (mm)	S (rev/min)	F (mm/min)
	Steel 24-32 HRC 	10	4	200	0.25	0.3	6	6450	6400
		12	5	300	0.25	0.3	7	7900	9800
		16	6	300	0.25	0.3	10	6000	9000
		20	7	300	0.25	0.3	13	4800	8400
		25	7	300	0.25	0.3	16	3850	6700
Steel 32-42 HRC 	10	4	100	0.25	0.3	6	3200	3200	
	12	5	130	0.25	0.3	7	3400	4200	
	16	6	130	0.25	0.3	10	2600	3900	
	20	7	130	0.25	0.3	13	2100	3700	
	25	7	130	0.25	0.3	16	1650	1900	
Stainless steel 	10	4	160	0.25	0.3	6	5160	5160	
	12	5	180	0.25	0.3	7	4700	5800	
	16	6	180	0.25	0.3	10	3600	5400	
	20	7	180	0.25	0.3	13	2900	5000	
	25	7	180	0.25	0.3	16	2300	4000	
Titanium alloy 	10	4	60	0.3	0.3	6	1900	2280	
	12	5	60	0.3	0.3	7	1600	2400	
	16	6	60	0.3	0.3	10	1200	2160	
	20	7	60	0.3	0.3	13	950	2000	
	25	7	60	0.3	0.3	16	770	1600	

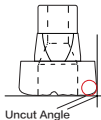
3BH	Part No.	Max (mm)	r_D (mm)	Uncut Angle (mm)
	3BH1005-M	0.8	0.9	0.21
	3BH1105-M	0.8	0.9	0.21
	3BH1205-M	0.9	1.15	0.29
	3BH1305-M	0.9	1.15	0.29
	3BH1605-M	1.2	1.30	0.37
	3BH1705-M	1.2	1.30	0.37
	3BH2005-M	1.2	1.35	0.41
	3BH2105-M	1.2	1.35	0.41
	3BH2505-M	1.2	1.45	0.51

High Feed Chamfer Milling Heads - 3BC

- Toolholders P. 149 -152
- Cutting Data P. 176

Dimensions (mm)					
D	L2	d	AP	C	Angle Chamfer
10	5	6	3.4	4.0	30°
			2.0	2.7	45°
			1.15	2.3	60°
13		9	3.4	4.0	30°
			2.0	2.7	45°
			1.15	2.3	60°
16		11	4.3	5.0	30°
			2.5	3.5	45°
			1.4	2.8	60°

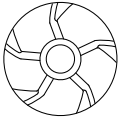

5 flutes
D: 10mm

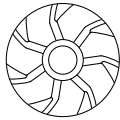

7 flutes
D: 13mm

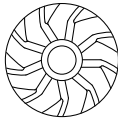

9 flutes
D: 16mm



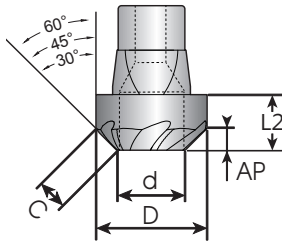

3BC



Tolerances (mm)

$$D : \begin{matrix} +0.0 \\ -0.01 \sim -0.02 \end{matrix} \quad L2 : \pm 0.03$$

Milling Heads	Part No.	Grades											
		Carbide				Metal cermet		Uncoated					
		B100	C200	C250	F20	F30	CE25	CE60	K10		CE		
	3BC1005-30°-ME	★											
	3BC1005-45°-ME	★											
	3BC1005-60°-ME	★											
	3BC1305-30°-ME	★											
	3BC1305-45°-ME	★											
	3BC1305-60°-ME	★											
	3BC1605-30°-ME	★											
	3BC1605-45°-ME	★											
	3BC1605-60°-ME	★											

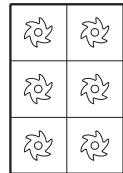







Inserts 6 PCS / Box

★ Applicable to all Materials

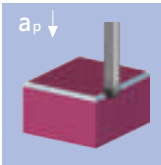
- Correct price and stock are based on current situation
- Please specify model number and grade of insert, ie.: 3BC1005-30°-ME,B100



Cutting Parameter **3BC**

3BC	Materials	D (mm)	Z	Vc (m/min)	fz (mm/tooth)	a _p (mm)	S (rev/min)	F (mm/min)
	Steel 24-32 HRC 	10	5	230	0.07	1C	7400	2600
		13	7	230	0.07	1C	5700	2800
		16	9	230	0.07	1C	4600	2900
	Steel 32-42 HRC 	10	5	130	0.06	1C	4200	1260
		13	7	130	0.06	1C	3250	1360
		16	9	130	0.06	1C	2650	1460
	Stainless steel 	10	5	180	0.06	1C	5800	1740
		13	7	180	0.06	1C	4500	1800
		16	9	180	0.06	1C	3600	1950
Titanium alloy 	10	5	70	0.06	1C	2250	670	
	13	7	70	0.06	1C	1750	730	
	16	9	70	0.06	1C	1400	750	
Aluminum 	10	5	500	0.07	1C	16000	5600	
	13	7	500	0.07	1C	12500	6100	
	16	9	500	0.07	1C	10200	6400	
Cast iron 	10	5	75	0.07	1C	2400	840	
	13	7	75	0.07	1C	1900	920	
	16	9	75	0.07	1C	1500	950	

Technical Data

• Ramping

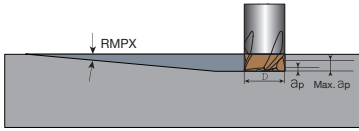

Unit : mm

Ø D	RMPX	Max. a _p
10	1.5°	1
12	1.5°	1
16	1.5°	1
20	1.5°	1
25	1.5°	1

• It's calculated with exchangeable milling head R0.

• Helical milling

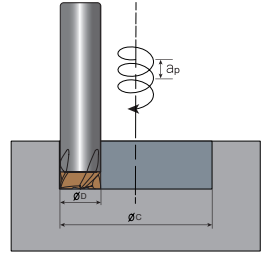

Unit : mm

Ø D	Min. ØC / Max. a _p			
	Min. ØC	Max. a _p mm	Max. ØC	Max. a _p mm
10	15	0.4	19	0.7
12	17	0.4	23	0.7
16	25	0.7	31	1.2
20	33	1.0	39	1.5
25	43	1.4	49	1.9

• It's calculated with exchangeable milling head R0.

Arbor and chuck

Precise arbor and chuck will improve the tool life in high speed machining.

Arbor recommendation:

Hydraulic chuck, shrink fit chuck or highly precision chuck.

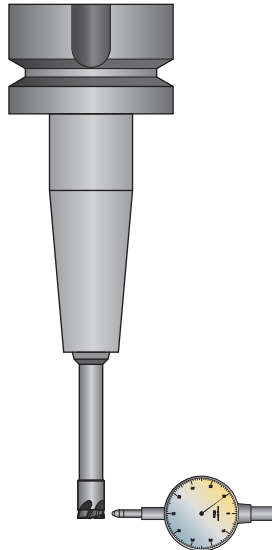

Different Applications

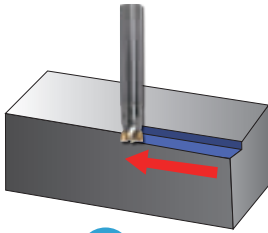

1

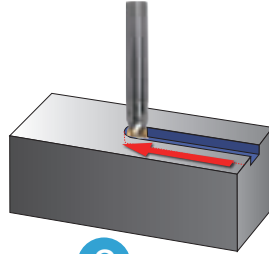

2

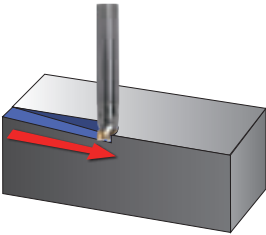

3

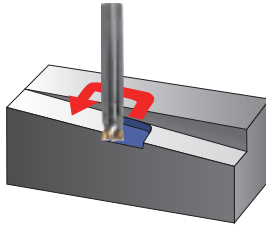

4

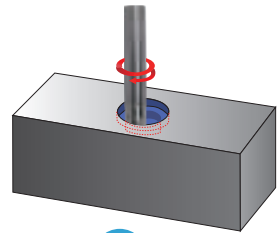

5

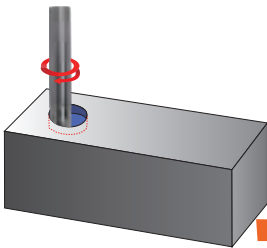

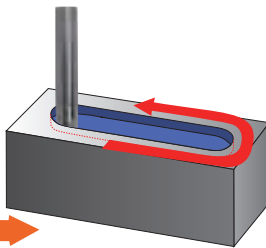

6



7

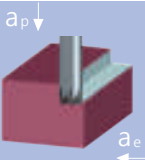

Test Report

3B	Material	D (mm)	Z	Vc (m/min)	f _z (mm/tooth)	a _p (mm)	a _e (mm)	S (rev/min)	F (mm/min)
	Stainless steel 	12	4	60	0.06	4.5	4.5	1600	400

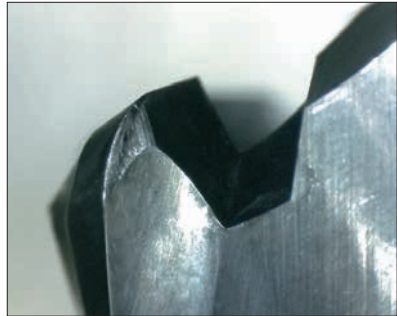
- Life time: 240 minutes
- 200 x magnification
- Tested tool:
Milling head (3B1206R0.5-ME, B100)
HSS shank (BB3-1212-70)

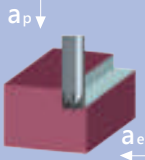

UFO MILL

3B	Material	D (mm)	Z	Vc (m/min)	f _z (mm/tooth)	a _p (mm)	a _e (mm)	S (rev/min)	F (mm/min)
	Steel 24-32 HRC 	12	4	120	0.06	4.5	4.5	3200	770

- Life time: 80 minutes
- 200 x magnification
- Tested tool:
Milling head (3B1206R0.5-M, B100)
HSS shank (BB3-1212-70)



SLITTING/ SLOTTING/ CUT-OFF SERIES

PATENTED



Video



The Safest Saw

Patented embedding system assures the rigidity of inserts clamping which enhances the tool life and cutting speed, meanwhile realize impressive productivities.

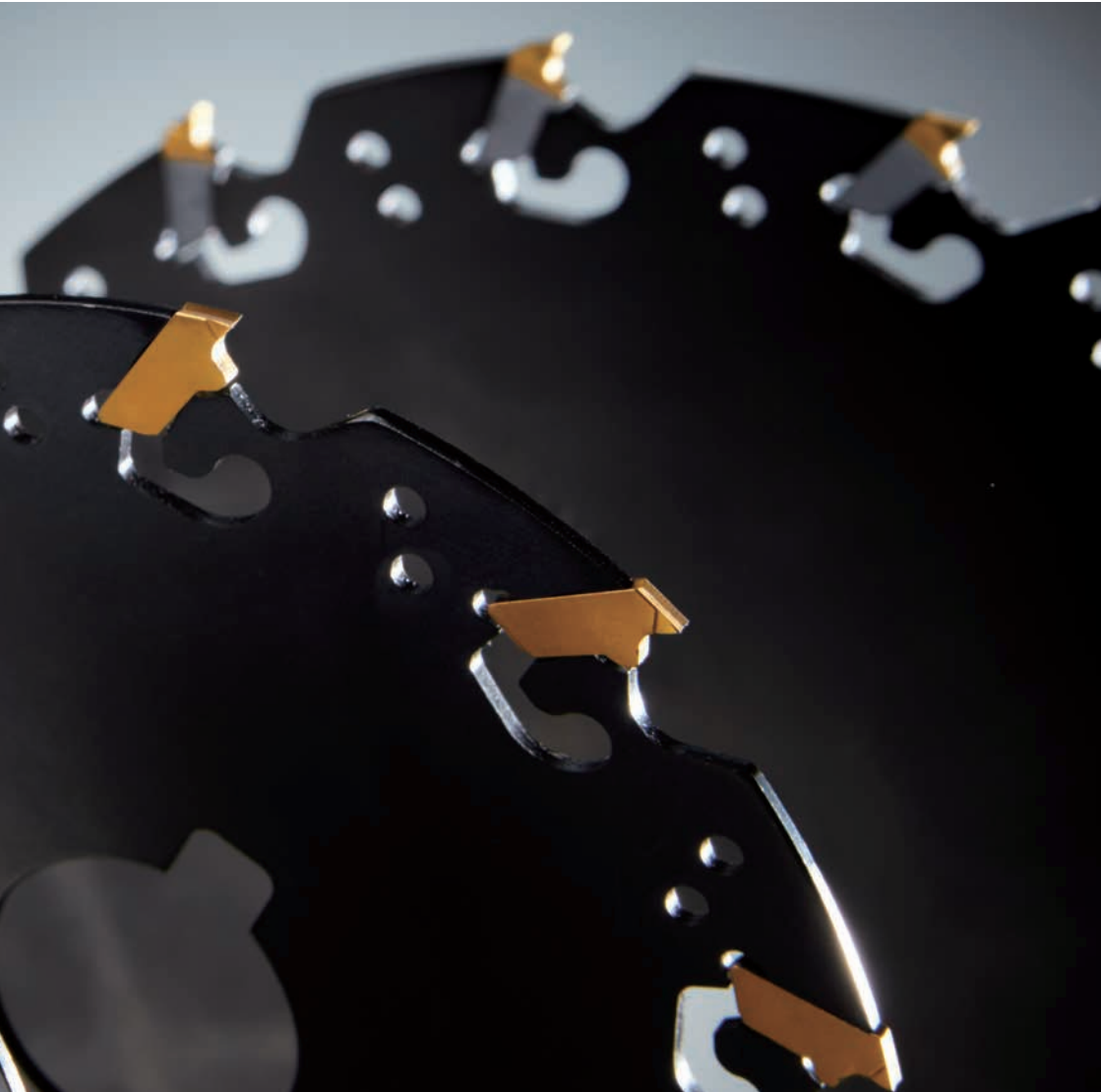

SAW BLADE

PATENTED



Video

Features

Available in materials



Cost
200~300%
SAVING

Applicable
Machines
Milling machine

Efficiency
300~500%
UP

Durability
300%
UP

SLITTING/SLOTTING/CUT-OFF SERIES

Classification table

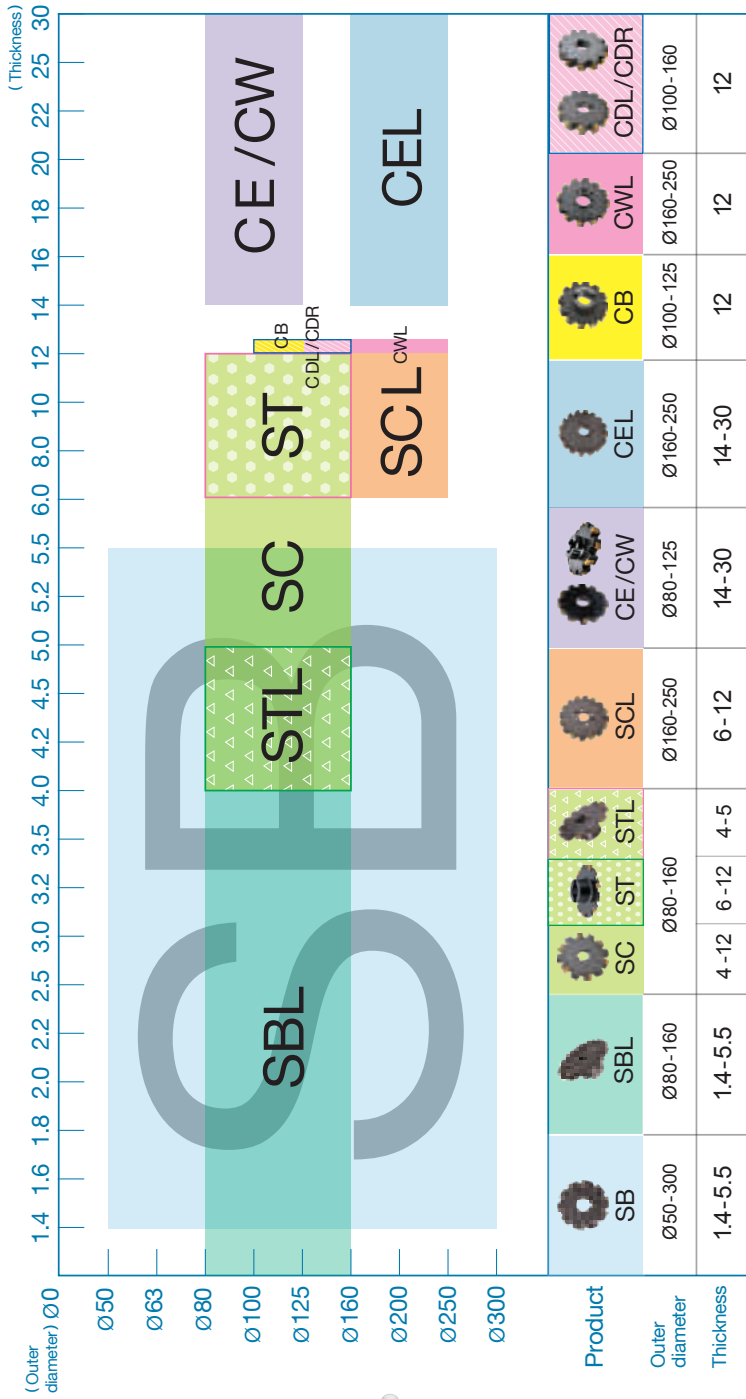

Unit: mm



Traditional vs. New Patent

"Yih Troun" is the first ever in the world which developed this precise locking type saw blade.



1. The screwless indexable insert was TiAlN coated and designed with exclusive geometric angle on the cutting edge for producing impressive performance.
2. It increasing the machining (cutting) speed 300% - 500%
3. Cut down the cost of cutting tools



Patent No. : M538848



Patent No. : ZL 2016 2 1300067.8



PCT Priority

Traditional

Solid type saw blade:

1. HSS Saw is only available with low cutting speed, if speed up, the blade will be damaged soon.
2. The carbide brazed saw is welded by high temperature and without coating, it will degrade the body hardness and machining performance.



Multi Functional Saw Blade

1 Same cutter applicable to inserts of :

A. Different materials



B. Different thickness

ex.: 1.75 mm cutter can fit inserts 2.0/2.2/2.5mm

C. Different insert forms

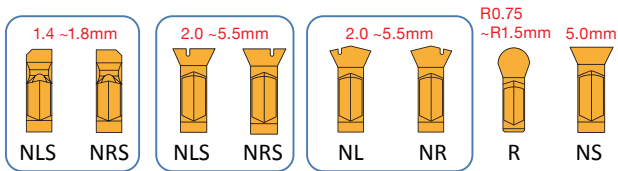

2 Patented embedding system

Strong clamping even in high feed machining



Circular embedding system achieves optimum performance in high speed machining, Max. RPM 17200 rev/min, approved in sweden.



Y.T. Patented Chip Breaking System

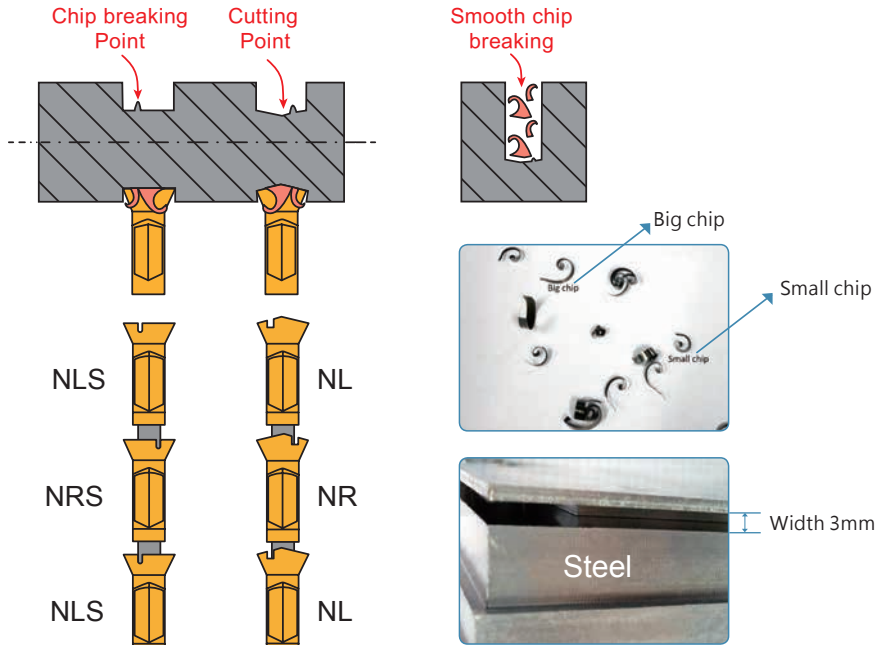

Excellent surface finishing quality and chip evacuation at the live test for machining 20mm deep slots by one pass

Characteristics

- The Insert has unique chip breaker design to break chips into two parts and chips are easily discharged while machining deep grooves and slots.
- It has accurate center positioning design which enables stronger and steady cutter conditions while machining, and lessens vibrations.
- Compare with the saw blades in the market, this design helps in reducing lots of cutting resistances and lower the machining power. It's the best choice for long depth and difficult materials machining.

Defect of other branded self-grip inserts

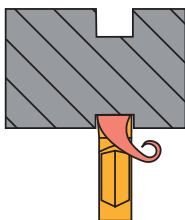

Characteristics

- While in deep grooving, chips often get stuck in the workpiece slot.
- Requires heavy power and generates large resistance in machining.
- As a result, it gives a be poor efficiency and heavy vibrations while large contact machining.

The Solution To Interrupted Cutting:

LNGT Radius Inserts

The radius insert with smooth entering cut provides excellent solution to the interrupted cutting, especially for slitting through the workpiece with holes inside.

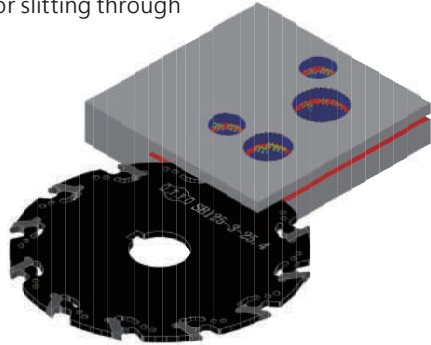

Slitting

Change The Inserts

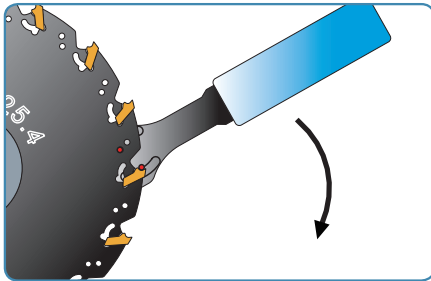

Mount inserts

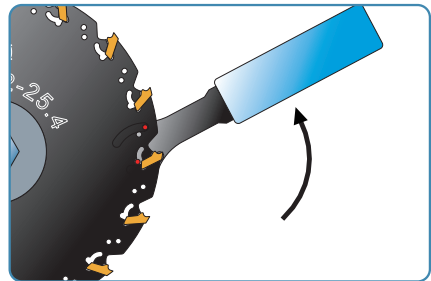

Remove inserts



Video



Before mounting inserts, use marker pen (oil-based) to wipe across the concave surface of the insert for helping fit the insert into the blade smoothly.



PRODUCT SPECIFICATIONS

Saw Blades

- Inserts P. 235 - 241
- Cutting Data P. 245 - 247

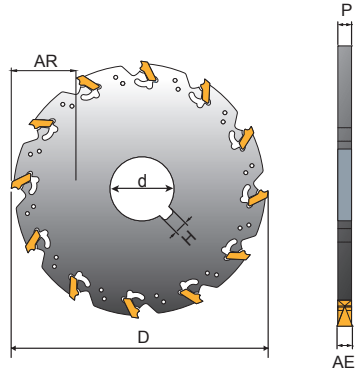

SB

Order Code	Dimensions (mm)							Z	H	KG	MAX. RPM	Insert LNGET	Wrench
	D	AE	AR	P	d	C	B						
SB050-1.4-13	50	1.4	14.5	1.2	13	-	-	4	-	0.07	12000	1414	150.10-30
SB050-1.4-12.7					12.7								
SB063-1.4-16	63		18		16			6	8000				
SB063-1.4-15.875					15.875								
SB080-1.4-22	80		19.5		22			6	0.09	8000			
SB080-1.4-25.4					25.4			6.35					
SB100-1.4-22	100		32.5		22			10	6	0.13	6300		
SB100-1.4-25.4									6.35				
SB100-1.4-27									7				
SB125-1.4-22	125		45		22			12	6	0.20	5000		
SB125-1.4-25.4									6.35				
SB125-1.4-32									8				

* Wrench 150.10-30 for above cutter order separately.

Saw Blades

- Inserts P. 235 - 241
- Cutting Data P. 245 - 247

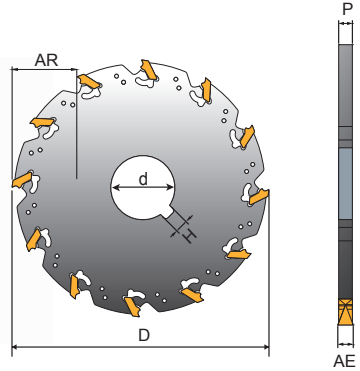

SB

Slitting

Order Code	Dimensions (mm)							Z	H	KG	MAX. RPM	Inserts LNGT	Wrench
	D	AE	AR	P	d	C	B						
SB050-1.6-13	50	1.6	14.5	1.4	13	-	-	4	-	0.08	12000	1616	150.10-30
SB050-1.6-12.7					12.7								
SB063-1.6-16	63	1.6	18	1.4	16	-	-	6	-	0.09	11000	1616	150.10-30
SB063-1.6-15.875					15.875								
SB080-1.6-22	80	1.6	22.5	1.4	22	-	-	8	6	0.09	8000	1616	150.10-30
SB080-1.6-25.4			19.5		25.4				6.35				
SB100-1.6-22	100	1.6	32.5	1.4	22	-	-	10	6	0.14	6300	1616	150.10-30
SB100-1.6-25.4			29.5		25.4				6.35				
SB100-1.6-27			27		7								
SB125-1.6-22	125	1.6	45	1.4	22	-	-	12	6	0.21	5000	1616	150.10-30
SB125-1.6-25.4			42		25.4				6.35				
SB125-1.6-32			39		32				8				
SB160-1.6-25.4	160	1.6	59.5	1.4	25.4	-	-	16	6.35	0.35	4000	1616	150.10-30
SB160-1.6-32			56.5		32				8				
SB160-1.6-40			52		40				10				

* Wrench 150.10-30 for above cutter order separately.



Saw Blades

- Inserts P. 235 - 241
- Cutting Data P. 245 - 247

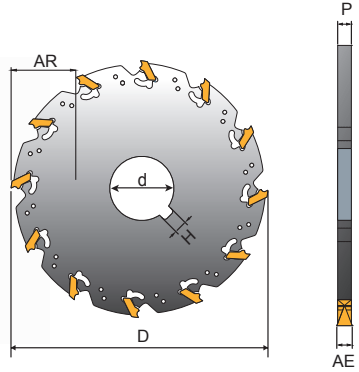

SB

Order Code	Dimensions (mm)							Z	H	KG	MAX. RPM	Inserts LNGT	Wrench
	D	AE	AR	P	d	C	B						
SB050-1.8-13	50	1.8	14.5	1.6	13	-	-	4	-	0.09	12000	1818	150.10-30
SB050-1.8-12.7					12.7								
SB063-1.8-16	63		18		16								
SB063-1.8-15.875					15.875								
SB080-1.8-22	80		22.5		22								
SB080-1.8-25.4			19.5		25.4								
SB100-1.8-22	100		32.5		22								
SB100-1.8-25.4			29.5		25.4								
SB100-1.8-27					27								
SB125-1.8-22	125		45		22								
SB125-1.8-25.4			42		25.4								
SB125-1.8-32			39		32								
SB160-1.8-25.4	160		59.5		25.4								
SB160-1.8-32			56.5		32								
SB160-1.8-40					52			40					

* Wrench 150.10-30 for above cutter order seperately.

Saw Blades

- Inserts P. 235 - 241
- Cutting Data P. 245 - 247

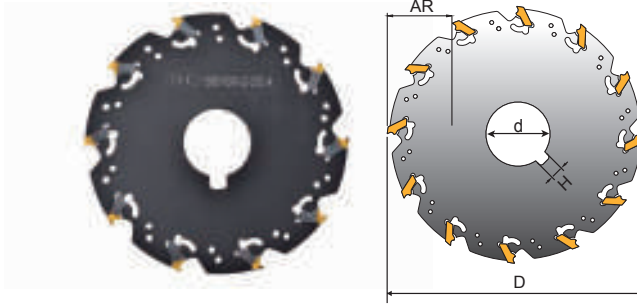

SB

Slitting

Order Code	Dimensions (mm)							Z	H	KG	MAX. RPM	Inserts LNGT	Wrench
	D	AE	AR	P	d	C	B						
SB050-2-13	50	2.0	14.5	1.7	13	-	-	4	-	0.08	12000	2020 2022 2025	150.10-30
SB050-2-12.7					12.7			6					
SB063-2-16	63		18		16				8	0.10	8000		
SB063-2-15.875					15.875								
SB080-2-22	80		22.5		22			6	0.16	6300			
SB080-2-25.4			19.5		25.4						6.35		
SB100-2-22	100		32.5		22			6	0.24	5000			
SB100-2-25.4			2.2		25.4			6.35					
SB100-2-27			2.5		29.5			27			7		
SB125-2-22	125		45		22			6	0.39	4000			
SB125-2-25.4			42		25.4			6.35					
SB125-2-32			39		32			8					
SB160-2-25.4	160	59.5	25.4	6.35	0.39	4000							
SB160-2-32		56.5	32	8									
SB160-2-40		52	40	10									

* Wrench 150.10-30 for above cutter order separately.



Saw Blades

- Inserts P. 235 - 241
- Cutting Data P. 245 - 247

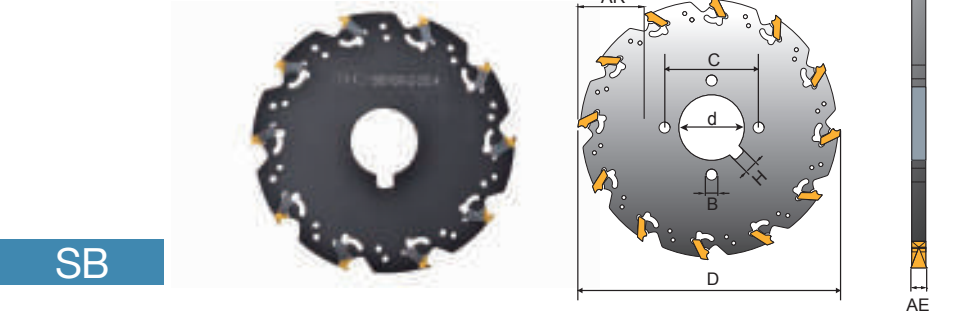

SB

Order Code	Dimensions (mm)							Z	H	KG	MAX. RPM	Inserts LNGT	Wrench
	D	AE	AR	P	d	C	B						
SB200-2-25.4	200	2.0	79.5	1.7	25.4	-	-	20	6.35	0.64	3200	2020	150.10-30
SB200M-2-25.4								26					
SB200-2-32			76.5		32	63	11	20	8				
SB200M-2-32								26					
SB200-2-40			72		40	90	20	10	3200				
SB200M-2-40							26						
SB250-2-25.4	250	2.2	104.5	1.7	25.4	-	-	26	6.35	0.96	2600	2025	150.10-30
SB250M-2-25.4		2.5						34					
SB250-2-32		101.5	32		63	11	26		8				
SB250M-2-32							34						
SB250-2-40		97	40		90	26	10						
SB250M-2-40						34							
SB285-2-32	285	119	32	63	28	8	1.12	2300					
SB285M-2-32					40								
SB050-2.5-13	50	2.5	14.5	2.25	13	-	-	4	-	0.1	12000	2525	150.10-30
SB050-2.5-12.7		2.7			12.7								
SB050-2.5-12.7		3.0											

* Wrench 150.10-30 for above cutter order separately.

Saw Blades

- Inserts P. 235 - 241
- Cutting Data P. 245 - 247

SB

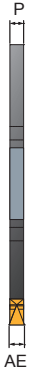
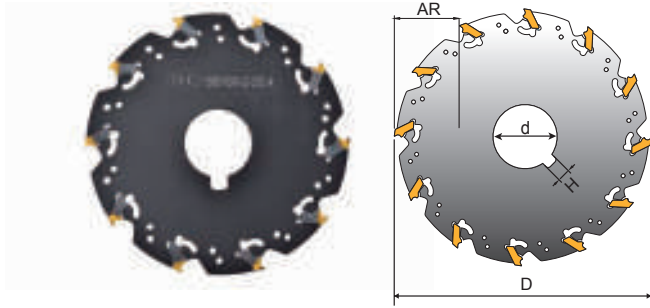

Slitting

Order Code	Dimensions (mm)							Z	H	KG	MAX. RPM	Inserts LNGT	Wrench
	D	AE	AR	P	d	C	B						
SB063-2.5-16	63	2.5	18	2.25	16	-	-	6	-	0.11	11000	2525	150.10-30
SB063-2.5-15.875					15.875								
SB080-2.5-22	80	2.5	22.5	2.25	22	-	-	8	6	0.12	8000	2525	150.10-30
SB080-2.5-25.4			19.5		25.4								
SB100-2.5-22	100	2.5	32.5	2.25	22	-	-	10	6	0.18	6300	2525	150.10-30
SB100-2.5-25.4			29.5		25.4								
SB100-2.5-27					27								
SB125-2.5-22	125	3.0	45	2.25	22	-	-	12	6	0.27	5000	2527	150.10-30
SB125-2.5-25.4			42		25.4								
SB125-2.5-32			39		32								
SB160-2.5-25.4	160	2.5	59.5	2.25	25.4	-	-	16	6.35	0.47	4000	2530	150.10-30
SB160-2.5-32			56.5		32								
SB160-2.5-40			52		40								
SB200-2.5-25.4	200	2.5	79.5	2.25	25.4	-	-	20	6.35	0.73	3200	2530	150.10-30
SB200M-2.5-25.4								26					

* Wrench 150.10-30 for above cutter order separately.



Saw Blades

- Inserts P. 235 - 241
- Cutting Data P. 245 - 247

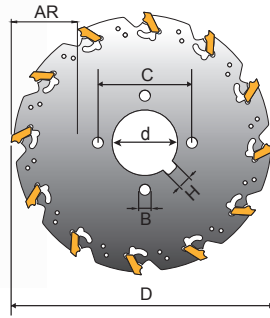

SB

Order Code	Dimensions (mm)							Z	H	⚖️ MAX. RPM	Inserts LNGT	Wrench		
	D	AE	AR	P	d	C	B							
SB200-2.5-32	200	2.5	76.5	2.25	32	63	11	20	8	0.73	3200	2525 2527 2530	150.10-30	
SB200M-2.5-32								26						
SB200-2.5-40			20		72	40	90	11	20					10
SB200M-2.5-40									26					
SB250-2.5-25.4	250	2.5	104.5	2.25	25.4	-	-	26	6.35	1.12	2600			
SB250M-2.5-25.4								34						
SB250-2.5-32			26		101.5	32	63	11	26					8
SB250M-2.5-32									34					
SB250-2.5-40			26		97	40	90	11	26					10
SB250M-2.5-40									34					
SB300-2.5-25.4	300	3.0	129.5	2.25	25.4	-	-	30	6.35	1.61	2200			
SB300M-2.5-25.4								40						
SB300-2.5-32			30		126.5	32	63	11	30			8		
SB300M-2.5-32									40					
SB300-2.5-40			30		122	40	90	11	30	10				
SB300M-2.5-40									40					

* Wrench 150.10-30 for above cutter order separately.

Saw Blades

- Inserts P. 235 - 241
- Cutting Data P. 245 - 247

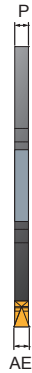
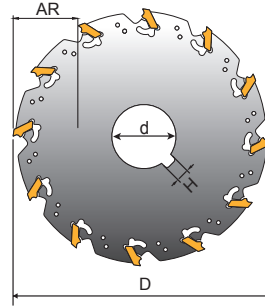

Slitting

SB

Order Code	Dimensions (mm)							Z	H	KG	MAX. RPM	Inserts LNGT	Wrench	
	D	AE	AR	P	d	C	B							
SB050-3-13	50	3.0	14.5	2.7	13	-	-	4	-	0.10	12000	3030	150.10-30	
SB050-3-12.7					12.7									
SB063-3-16	63		18		16			6	-	0.11	11000			
SB063-3-15.875					15.875									
SB080-3-22	80		22.5		22			8	6	0.13	8000			
SB080-3-25.4			19.5		25.4				6.35					
SB100-3-22	100		32.5		22			10	6	0.20	6300			
SB100-3-25.4			29.5		25.4				6.35					
SB100-3-27					3.2				27					7
SB125-3-22	125		3.5		45			22	12	6	0.31			5000
SB125-3-25.4			42		25.4			6.35						
SB125-3-32					39			32		8				
SB160-3-25.4		160	59.5	25.4	16	6.35	0.53	4000						
SB160-3-32	56.5		32	8										
SB160-3-40	52		40	10										
SB200-3-25.4	200	79.5	25.4	20	6.35	0.85	3200							
SB200M-3-25.4								26						

* Wrench 150.10-30 for above cutter order separately.



Saw Blades

- Inserts P. 235 - 241
- Cutting Data P. 245 - 247

SB

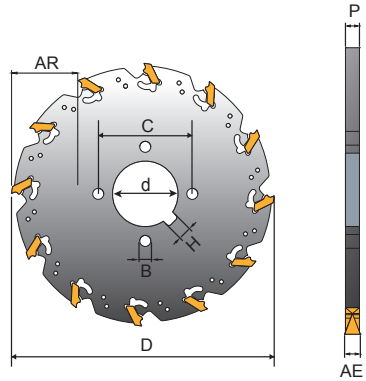

Order Code	Dimensions (mm)							Z	H	KG	MAX. RPM	Inserts LNGT	Wrench
	D	AE	AR	P	d	C	B						
SB200-3-32	200		76.5	2.7	32	63	11	20	8	0.85	3200		
SB200M-3-32								26					
SB200-3-40			72		40	90	20	10					
SB200M-3-40							26						
SB250-3-25.4	250	3.0	104.5	2.7	25.4	-	-	26	6.35	1.38	2600	3030	150.10-30
SB250M-3-25.4							34						
SB250-3-32			101.5		32	63	26	8					
SB250M-3-32							34						
SB250-3-40			97		40	90	26	10					
SB250M-3-40									34				
SB300-3-25.4	300	3.2	129.5	2.7	25.4	-	-	30	6.35	1.86	2200	3032	150.10-30
SB300M-3-25.4							40						
SB300-3-32			126.5		32	63	11	30	8				
SB300M-3-32													
SB300-3-40			122		40	90	30	10					
SB300M-3-40									40				

* Wrench 150.10-30 for above cutter order separately.

Saw Blades

- Inserts P. 235 - 241
- Cutting Data P. 245 - 247

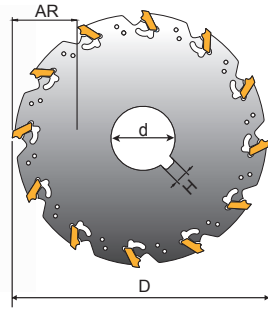

SB

Slitting

Order Code	Dimensions (mm)							Z	H	KG	MAX. RPM	Inserts LNGT	Wrench
	D	AE	AR	P	d	C	B						
SB050-4-13	50	4.0	14.5	3.7	13	-	-	0.09	12000	4040	150.10-30		
SB050-4-12.7					12.7								
SB063-4-16	63	4.0	18	3.7	16	-	-	0.12	11000	4045	150.10-30		
SB063-4-15.875					15.875								
SB080-4-22	80	4.0	22.5	3.7	22	-	-	0.15	8000	4045	150.10-30		
SB080-4-25.4			19.5		25.4								
SB100-4-22	100	4.2	32.5	3.7	22	-	-	0.25	6300	4045	150.10-30		
SB100-4-25.4			29.5		25.4								
SB100-4-27			27		27								
SB125-4-22	125	4.5	45	3.7	22	-	-	0.40	5000	4045	150.10-30		
SB125-4-25.4			42		25.4								
SB125-4-32			39		32								
SB160-4-25.4	160	4.5	59.5	3.7	25.4	-	-	0.66	4000	4045	150.10-30		
SB160-4-32			56.5		32								
SB160-4-40			52		40								
SB200-4-25.4	200	4.5	79.5	3.7	25.4	-	-	1.02	3200	4045	150.10-30		
SB200M-4-25.4												20	26

* Wrench 150.10-30 for above cutter order separately.



Saw Blades

- Inserts P. 235 - 241
- Cutting Data P. 245 - 247

SB

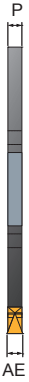
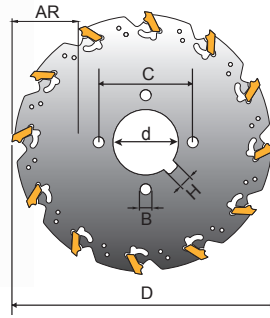

Order Code	Dimensions (mm)							Z	H	KG	MAX. RPM	Inserts LNGT	Wrench
	D	AE	AR	P	d	C	B						
SB200-4-32	200	4.0	76.5	3.7	32	63	11	20	8	1.02	3200		
SB200M-4-32								26					
SB200-4-40			72		40	90		20	10				
SB200M-4-40								26					
SB250-4-25.4	250	4.0	104.5	3.7	25.4	-	11	26	6.35	1.69	2600	4040	150.10-30
SB250M-4-25.4								34					
SB250-4-32			101.5		32	63		26	8				
SB250M-4-32								34					
SB250-4-40			97		40	90		26	10				
SB250M-4-40								34					
SB300-4-25.4	300	4.2	129.5	3.7	25.4	-	11	30	6.35	2.18	2200	4042	150.10-30
SB300M-4-25.4								40					
SB300-4-32			126.5		32	63		30	8				
SB300M-4-32								40					
SB300-4-40			122		40	90		30	10				
SB300M-4-40								40					

* Wrench 150.10-30 for above cutter order separately.

Saw Blades

- Inserts P. 235 - 241
- Cutting Data P. 245 - 247

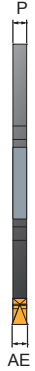
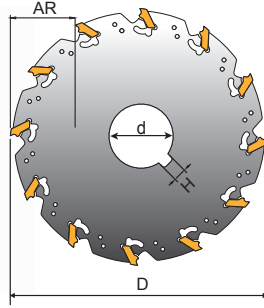

Slitting

SB

Order Code	Dimensions (mm)							Z	H	KG	MAX. RPM	Inserts LNGT	Wrench
	D	AE	AR	P	d	C	B						
SB050-5-13	50	5.0	14.5	4.5	13	-	-	4	-	0.13	12000	5050	150.10-30
SB050-5-12.7					12.7								
SB063-5-16	63	5.2	18	4.5	16	-	-	6	-	0.18	11000	5052	150.10-30
SB063-5-15.875					15.875								
SB080-5-22	80	5.5	22.5	4.5	22	-	-	8	6	0.18	8000	5055	150.10-30
SB080-5-25.4			19.5		25.4				6.35				
SB100-5-22	100	5.0	32.5	4.5	22	-	-	10	6	0.28	6300	5050	150.10-30
SB100-5-25.4		5.2	29.5		25.4				6.35				
SB100-5-27		5.5	27		27				7				
SB125-5-22	125	5.5	45	4.5	22	-	-	12	6	0.45	5000	5055	150.10-30
SB125-5-25.4			42		25.4				6.35				
SB125-5-32			39		32				8				
SB160-5-25.4	160	5.5	59.5	4.5	25.4	-	-	16	6.35	0.75	4000	5055	150.10-30
SB160-5-32			56.5		32				8				
SB160-5-40			52		40				10				

* Wrench 150.10-30 for above cutter order separately.



ADAPTER HOLDER SERIES



Video

Features

Available in
materials



Cost
200~300%
SAVING

Applicable
Machines
Milling machine

Efficiency
300~500%
UP

Durability
300%
UP

New System For T-Slot Milling

ADAPTER HOLDER

Slotting

Slitting / Slotting / Cut-off

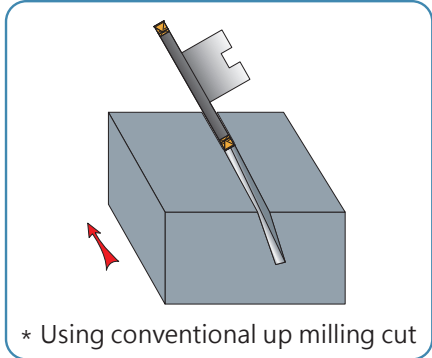
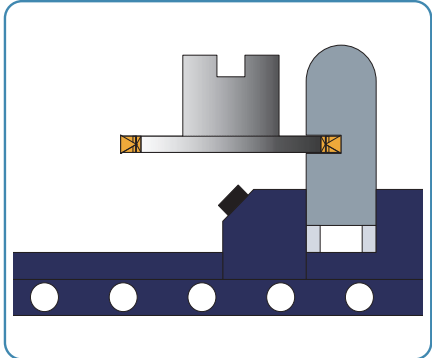
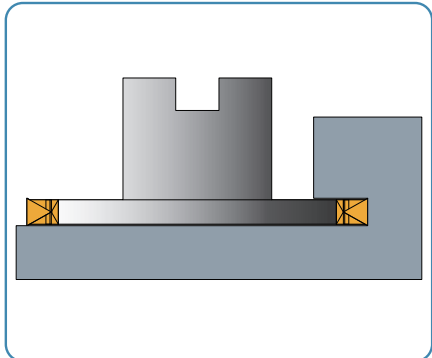
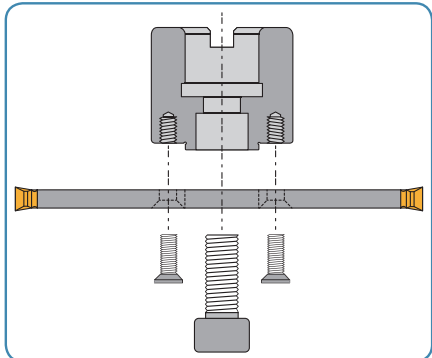

PRODUCT SPECIFICATIONS

Saw Milling Cutters

- Adapter Holders P. 206
- Inserts P. 235 - 241
- Cutting Data P. 245 - 247

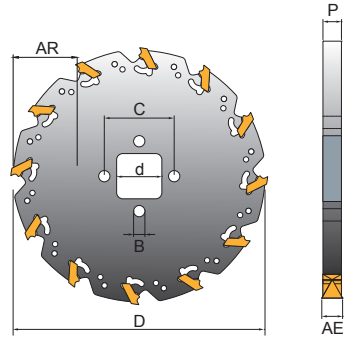

SBL

Order Code	Dimensions (mm)							Z	H	KG	MAX. RPM	Inserts LNGT	Wrench
	D	AE	AR	P	d	C	B						
SBL080-1.4-22	80	1.4	17	1.2	22	34	5	8	-	0.08	8000	1414	150.10-30
SBL100-1.4-22	100		27					32		46	6		
SBL125-1.4-32	125	33	16		0.18	5000	0.33					4000	
SBL160-1.4-32	160	50.5											
SBL080-1.6-22	80	1.6	17	1.4	22	34	5	8	-	0.09	8000	1616	150.10-30
SBL100-1.6-22	100		27					32		46	6		
SBL125-1.6-32	125		33		16	0.19	5000					0.35	
SBL160-1.6-32	160		50.5										

* Wrench 150.10-30 for above cutter order separately.

Saw Milling Cutters

- Adapter Holders P. 206
- Inserts P. 235 - 241
- Cutting Data P. 245 - 247

SBL

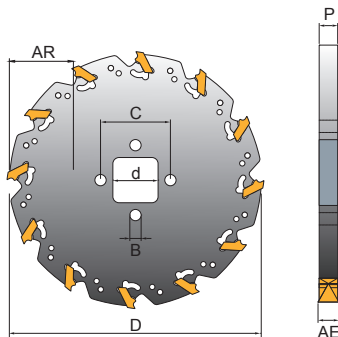

Slotting

Order Code	Dimensions (mm)							Z	H	KG	MAX. RPM	Inserts LNGT	Wrench
	D	AE	AR	P	d	C	B						
SBL080-1.8-22	80	1.8	17	1.6	22	34	5	8	-	0.10	8000	1818	150.10-30
SBL100-1.8-22	100		27					10		0.15	6300		
SBL125-1.8-32	125		33		12	0.21	5000						
SBL160-1.8-32	160		50.5		16	0.37	4000						
SBL080-2-22	80	2.0	17	1.7	22	34	5	8	-	0.10	8000	2020 2022 2025	150.10-30
SBL100-2-22	100		27					10		0.15	6300		
SBL125-2-32	125		2.2		33	12	0.22	5000					
SBL160-2-32	160		2.5		50.5	16	0.39	4000					
SBL080-2.5-22	80	2.5	17	2.25	22	34	5	8	-	0.11	8000	2525 2527 2530	150.10-30
SBL100-2.5-22	100		27					10		0.17	6300		
SBL125-2.5-32	125		2.7		33	12	0.26	5000					
SBL160-2.5-32	160		3.0		50.5	16	0.45	4000					

* Wrench 150.10-30 for above cutter order seperately.



Saw Milling Cutters

- Adapter Holders P. 206
- Inserts P. 235 - 241
- Cutting Data P. 245 - 247

SBL

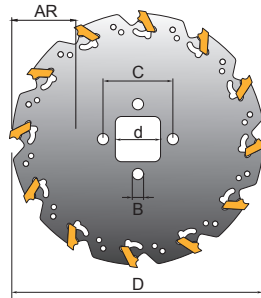

Order Code	Dimensions (mm)							Z	H	KG	MAX. RPM	Inserts LNGLT	Wrench		
	D	AE	AR	P	d	C	B								
SBL080-3-22	80	3.0	17	2.7	22	34	5	8	-	0.12	8000	3030	150.10-30		
SBL100-3-22	100		27					10		0.20				6300	3032
SBL125-3-32	125		33					12		0.29				5000	3035
SBL160-3-32	160		50.5					16		0.51				4000	
SBL080-4-22	80	4.0	17	3.7	22	34	5	8	-	0.15	8000	4040	150.10-30		
SBL100-4-22	100		27					10		0.24				6300	4042
SBL125-4-32	125		33					12		0.36				5000	4045
SBL160-4-32	160		50.5					16		0.64				4000	
SBL080-5-22	80	5.0	17	4.5	22	34	5	8	-	0.17	8000	5050	150.10-30		
SBL100-5-22	100		27					10		0.27				6300	5052
SBL125-5-32	125		33					12		0.42				5000	5055
SBL160-5-32	160		50.5					16		0.74				4000	

* Wrench 150.10-30 for above cutter order separately.

Side Milling Cutters

- Adapter Holders P. 206
- Inserts P. 242 - 244
- Cutting Data P. 248 - 249

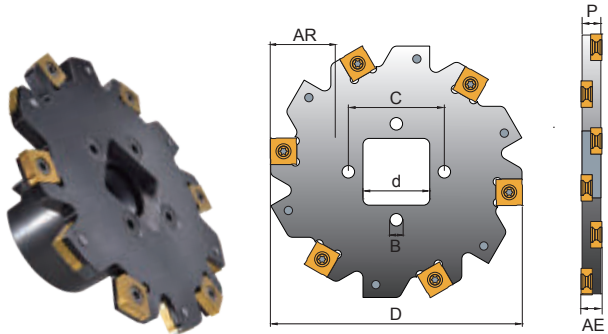

STL

Slotting

Order Code	Dimensions (mm)							Z	Zc	 KG	MAX. RPM	Inserts SNGX SNGW	Screw	Key
	D	AE	AR	P	d	C	B							
STL080-4-22	80	4	17	3.4	22	34	5	8	4	0.16	13700	1102	T9354	T09P
STL080-5-22		5		4.2								1103	T9355	T08P
STL100-4-22	100	4	27	3.4	32	46	6	10	5	0.26	12000	1102	T9354	T09P
STL100-5-22		5		4.2								1103	T9355	T08P
STL125-4-32	125	4	33	3.4	32	46	6	12	6	0.37	10900	1102	T9354	T09P
STL125-5-32		5		4.2								1103	T9355	T08P
STL160-4-32	160	4	50.5	3.4	32	46	6	16	8	0.68	8300	1102	T9354	T09P
STL160-5-32		5		4.2								1103	T9355	T08P

* Use Zc (effective no. of teeth) to calculate the feed.

* Fit Insert SNGW...R2.5 and R3.0, cutter have to modified (ask salesman).



Adapter Holders

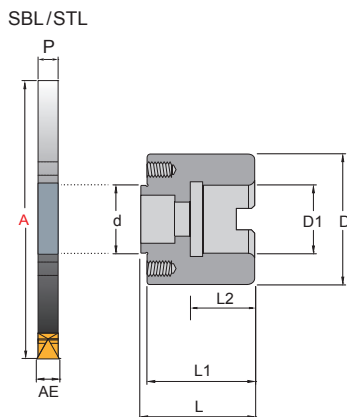
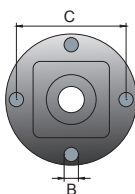

BL / BLL

Order Code	Dimensions (mm)									KG	Available P	
	D	D1	d	C	B	L	L1	L2	A			
BL45-22	45	22	22	34	5	43	41.8	27	80 100	0.47	 1.2-2.25mm	
BL45-25.4		25.4				45						43.8
BL58-31.75	58	31.75	32	46	6	55	53.8	28	125 160	0.95		
BL58-32		32				55						
BLL45-22	45	22	22	34	5	43	40.5	27	80 100	0.47		 2.7-4.5mm
BLL45-25.4		25.4				45						
BLL58-31.75	58	31.75	32	46	6	55	52.5	28	125 160	0.95		
BLL58-32		32				55						

* Please follow the step 1 · 2 · 3 to choose the cutter and holder to match: 1. Available P 2. "d" size 3. "D1" size.

Standard Spare Parts

Holder	Screw	Holder	Screw	Arbor Screw	
BL45-22	 C90512	BLL45-22	 C90512	 M1035	
BL45-25.4		BLL45-25.4		M1235	
BL58-31.75	 C90612	BLL58-31.75	 C90612	M1235/M1635/ W2403	
BL58-32		BLL58-32		M1635	

SOLUTION-1

SBL/STL Series



Face Milling Arbor:
Better strength with shorter length and bigger diameter

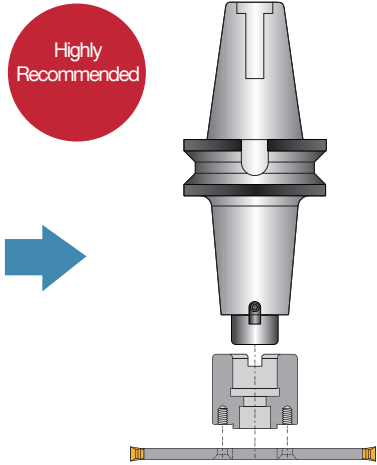

SOLUTION-2

SB Series



Side Milling Arbor:
Poor strength with longer length and smaller diameter

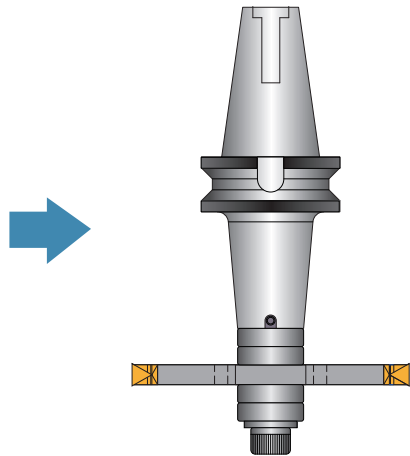

It might cause mechanism interferences.



ADAPTER HOLDER SERIES



Features

Available in materials



Cost
200~300%
SAVING

Applicable
Machines
Milling machine

Efficiency
300~500%
UP

Durability
300%
UP

PRODUCT SPECIFICATIONS

Side Milling Cutters

- Adapter Holders P. 212
- Inserts P. 242 - 244
- Cutting Data P. 248 - 249

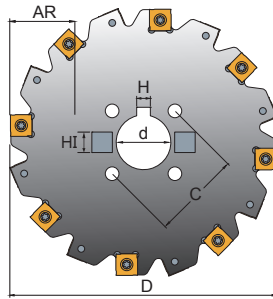

Slotting

SCL

Order Code	Dimensions (mm)								Z	Zc	KG	MAX. RPM	Inserts SNGX SNGW	Screw	Key
	D	AE	AR	P	H	C	d	HI							
SCL-160-6-32	160	6	46.5	5	8	52	32	12X12	16	8	8300	1203	T945	T15P	
SCL-160-8-32		8		7											
SCL-160-10-32		10		9											
SCL-160-12-32		12		11											
SCL-200-6-40	200	6	54	5	10	70	40	12X12	18	9	4200	1203	T945		
SCL-200-8-40		8		7											
SCL-200-10-40		10		9											
SCL-200-12-40		12		11											
SCL-250-6-40	250	6	79	5	10	70	40	12X12	24	12	3800	1203	T945		
SCL-250-8-40		8		7											
SCL-250-10-40		10		9											
SCL-250-12-40		12		11											

* Use Zc (effective no. of teeth) to calculate the feed.

* Fit Insert SNGW...R2.5 and R3.0, cutter have to modified (ask salesman).



Disc Milling Cutters

- Adapter Holders P. 212
- Inserts P. 245
- Cutting Data P. 250 - 251

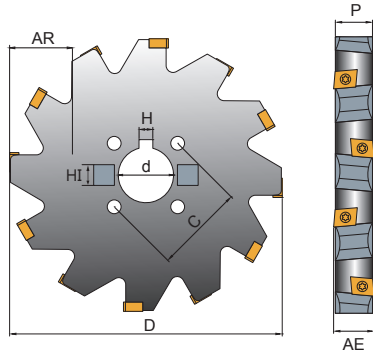

CEL

Order Code	Dimensions (mm)								Z	Zc	Ⓚ /KG	MAX. RPM	Inserts CNGX	Screw	Key		
	D	AE	AR	P	H	C	d	HI									
CEL-160-14-32	160	14	46.5	12.5	8	52	32	12X12	12	6	1.72	6900	1005	C04011	T15P		
CEL-160-16-32		16		14.5							1.95						
CEL-160-18-32		18		16.5							2.19						
CEL-160-20-32		20		18.5							2.44					1305	
CEL-160-22-32		22		20.5							2.68						
CEL-160-25-32		25		23.5							3.04						1605
CEL-160-30-32		30		28.5							3.64						
CEL-200-14-40		200		14							54					12.5	10
CEL-200-16-40	16		14.5	3.06													
CEL-200-18-40	18		16.5	3.44													
CEL-200-20-40	20		18.5	3.82	1305												
CEL-200-22-40	22		20.5	4.20													
CEL-200-25-40	25		23.5	4.77		1605											
CEL-200-30-40	30		28.5	5.72													

* Use Zc (effective no. of teeth) to calculate the feed.

Disc Milling Cutters

- Adapter Holders P. 212
- Inserts P. 245
- Cutting Data P. 250 - 251

CEL

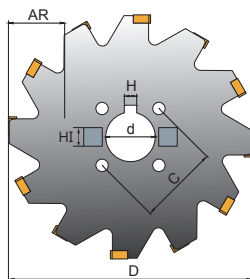

Order Code	Dimensions (mm)								Z	Zc	KG	MAX. RPM	Inserts CNGX	Screw	Key
	D	AE	AR	P	H	C	d	HI							
CEL-250-14-40	250	14	79	12.5	10	70	40	12X12	20	10	5500	1305	C04011	T15P	
CEL-250-16-40		16		14.5											
CEL-250-18-40		18		16.5											
CEL-250-20-40		20		18.5											
CEL-250-22-40		22	20.5	16					8						
CEL-250-25-40		25	23.5							1605					
CEL-250-30-40		30	28.5												

* Use Zc (effective no. of teeth) to calculate the feed.



Back Milling Cutters

- Adapter Holders P. 212
- Inserts P. 245
- Cutting Data P. 250 - 251

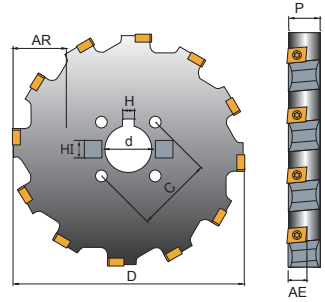

CWL

Order Code	Dimensions(mm)								Z	KG	MAX. RPM	Inserts CNGX	Screw	Key
	D	AE	AR	P	H	C	d	HI						
CWL-160-32	160	12	46.5	16.5	8	52	32	12X12	16	1.90	6900	1305	C04011	T15P
CWL-200-40	200		54		10	70	40		20	2.30	6100			
CWL-250-40	250		79						24	3.20	5500			

Adapter Holders

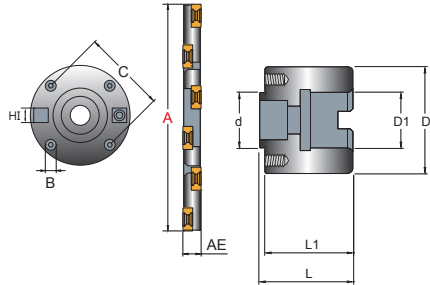

BCL

Order Code	Dimensions (mm)									KG
	D	D1	d	C	B	L	L1	A	HI	
BCL65-31.75	65	31.75	32	52	8	50	44.5	160	12X12	0.84
BCL65-32		32								
BCL65-38.1		38.1								
BCL65-40		40								
BCL90-38.1	90	38.1	40	70	8	60	54.5	200 250	12X12	1.70
BCL90-40		40								1.78
BCL90-50		50								1.80
BCL90-50.8		50.8				1.85				
BCL90-60		60				1.90				

Standard Spare Parts

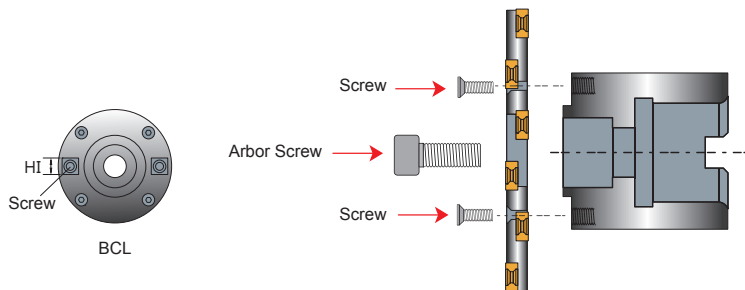

Slotting

Holders	Screw	Arbor Screw	HI+Screw	Holders	Screw	Arbor Screw	HI+Screw
SCL-160-6-32	C90815	M1650	W12.12.8 + M0510	CEL-160-14-32	C90820	M1650	W12.12.8 + M0510
SCL-160-8-32				CEL-160-16-32	C90825		
SCL-160-10-32	C90820	CEL-160-18-32		C90830			
SCL-160-12-32	C90815	CEL-160-20-32		C90835			
SCL-200-6-40	C90820	CEL-160-22-32		C90820			
SCL-200-8-40	C90815	CEL-160-25-32		C90825			
SCL-200-10-40	C90820	CEL-200-14-40		C90830			
SCL-200-12-40	C90815	CEL-200-16-40		C90835			
SCL-250-6-40	C90820	CEL-200-18-40		C90820			
SCL-250-8-40	C90815	CEL-200-20-40		C90825			
SCL-250-10-40	C90820	CEL-200-22-40		C90830			
SCL-250-12-40	C90815	CEL-200-25-40		C90835			
CWL-160-32	C90825	CEL-200-30-40	C90820				
CWL-200-40	C90815	CEL-250-14-40	C90825				
CWL-250-40	C90820	CEL-250-16-40	C90830				
		CEL-250-18-40	C90835				
		CEL-250-20-40	C90820				
		CEL-250-22-40	C90825				
		CEL-250-25-40	C90830				
		CEL-250-30-40	C90835				



SIDE MILLING CUTTER



Video

Features

Available in materials



Cost
200~300%
SAVING

Applicable
Machines
Milling machine

Efficiency
300~500%
UP

Durability
300%
UP

PRODUCT SPECIFICATIONS

Side Milling Cutters

- Inserts P. 242 - 244
- Cutting Data P. 248 - 249

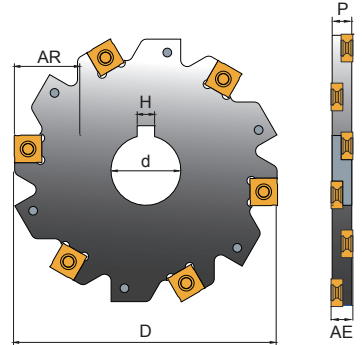

Slotting

SC

Order Code	Dimensions (mm)						Z	Zc	KG	MAX. RPM	Inserts SNGX SNGW	Screw	Key
	D	AE	AR	P	H	d							
SC-80-4-22	80	4	22.5	3.4	6	22	8	4	13700	1102	T9354	T09P	
SC-80-5-22		5		4.2						1103	T9355	T08P	
SC-80-6-22		6		5						1203	T945	T15P	
SC-80-7-22		7		6						1204	T946		
SC-80-8-22		8		7						12045	T947		
SC-80-10-22		10		9						1205	T948		
SC-80-12-22		12	11	1207	T9411								
SC-80-4-25.4		4	19.5	3.4	6.35	25.4				1102	T9354	T09P	
SC-80-5-25.4		5		4.2						1103	T9355	T08P	
SC-80-6-25.4		6		5						1203	T945	T15P	
SC-80-7-25.4		7		6						1204	T946		
SC-80-8-25.4		8		7						12045	T947		
SC-80-10-25.4	10	9		1205			T948						
SC-80-12-25.4	12	11	1207	T9411									

* Use Zc (effective no. of teeth) to calculate the feed.

* Fit Insert SNGW...R2.5 and R3.0, cutter have to modified (ask salesman).



Side Milling Cutters

- Inserts P. 242 - 244
- Cutting Data P. 248 - 249

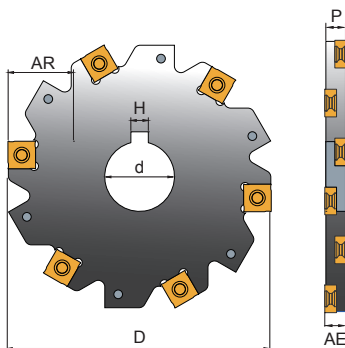

SC

Order Code	Dimensions (mm)						Z	Zc	KG	MAX. RPM	Inserts SNGX SNGW	Screw	Key						
	D	AE	AR	P	H	d													
SC-100-4-25.4	100	4	29.5	3.4	6.35	25.4	10	5	12000	1102	T9354	T09P							
SC-100-5-25.4		5		4.2															
SC-100-6-25.4		6		5															
SC-100-7-25.4		7		6															
SC-100-8-25.4		8		7															
SC-100-10-25.4		10		9															
SC-100-12-25.4		12	11																
SC-100-4-27		100	4	29.5	3.4	7							27	10	5	12000	1102	T9354	T09P
SC-100-5-27			5		4.2														
SC-100-6-27			6		5														
SC-100-7-27			7		6														
SC-100-8-27			8		7														
SC-100-10-27	10		9																
SC-100-12-27	12		11																

* Use Zc (effective no. of teeth) to calculate the feed.

* Fit Insert SNGW...R2.5 and R3.0, cutter have to modified (ask salesman).

Side Milling Cutters

- Inserts P. 242 - 244
- Cutting Data P. 248 - 249

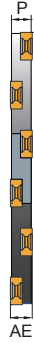
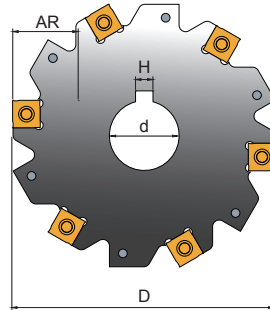

Slotting

SC

Order Code	Dimensions (mm)						Z	Zc	KG	MAX. RPM	Inserts SNGX SNGW	Screw	Key					
	D	AE	AR	P	H	d												
SC-125-4-32	125	4	39	3.4	8	32	12	6	10900	1102	T9354	T09P						
SC-125-5-32		5		4.2						1103	T9355	T08P						
SC-125-6-32		6		5						1203	T945	T15P						
SC-125-7-32		7		6						1204	T946							
SC-125-8-32		8		7						12045	T947							
SC-125-10-32		10		9						1205	T948							
SC-125-12-32		12		11						1207	T9411							
SC-125-4-40		4		34.5						3.4	10		40	12	6	10900	1102	T9354
SC-125-5-40		5								4.2		1103					T9355	T08P
SC-125-6-40		6								5		1203					T945	T15P
SC-125-7-40		7								6		1204					T946	
SC-125-8-40		8								7		12045					T947	
SC-125-10-40	10	9	1205		T948													
SC-125-12-40	12	11	1207		T9411													

* Use Zc (effective no. of teeth) to calculate the feed.
 * Fit Insert SNGW...R2.5 and R3.0, cutter have to modified (ask salesman).



Side Milling Cutters

- Inserts P. 242 - 244
- Cutting Data P. 248 - 249

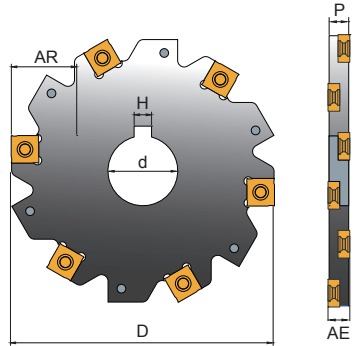

SC

Order Code	Dimensions (mm)						Z	Zc	KG	MAX. RPM	Inserts SNGX SNGW	Screw	Key			
	D	AE	AR	P	H	d										
SC-125-4-25.4	125	4	42	3.4	6.35	25.4	12	6	10900	1102	T9354	T09P				
SC-125-5-25.4		5		4.2						T9355	T08P					
SC-125-6-25.4		6		5						T945	T15P					
SC-125-7-25.4		7		6						T946						
SC-125-8-25.4		8		7						T947						
SC-125-10-25.4		10		9						T948						
SC-125-12-25.4		12	11	T9411												
SC-125-4-31.75		39	4	8	3.4	31.75				31.75	12	6	10900	1102	T9354	T09P
SC-125-5-31.75			5		4.2									T9355	T08P	
SC-125-6-31.75			6		5									T945	T15P	
SC-125-7-31.75			7		6									T946		
SC-125-8-31.75			8		7									T947		
SC-125-10-31.75	10		9		T948											
SC-125-12-31.75	12		11		T9411											

* Use Zc (effective no. of teeth) to calculate the feed.
 * Fit Insert SNGW...R2.5 and R3.0, cutter have to modified (ask salesman).

Side Milling Cutters

- Inserts P. 242 - 244
- Cutting Data P. 248 - 249

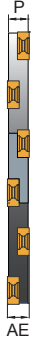
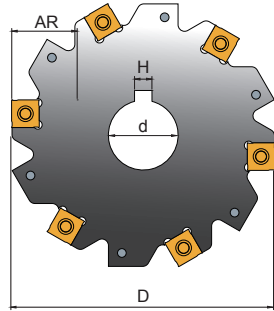

Slotting

SC

Order Code	Dimensions (mm)						Z	Zc	KG	MAX. RPM	Inserts SNGX SNGW	Screw	Key			
	D	AE	AR	P	H	d										
SC-160-4-32	160	4	56.5	3.4	8	32	16	8	8300	1102	T9354	T09P				
SC-160-5-32		5		4.2						T1103	T9355	T08P				
SC-160-6-32		6		5						1203	T945	T15P				
SC-160-7-32		7		6						1204	T946					
SC-160-8-32		8		7						12045	T947					
SC-160-10-32		10		9						1205	T948					
SC-160-12-32		12	11	1207	T9411											
SC-160-4-40		160	4	52	3.4	10				40	16	8	8300	1102	T9354	T09P
SC-160-5-40			5		4.2									1103	T9355	T08P
SC-160-6-40			6		5									1203	T945	T15P
SC-160-7-40			7		6									1204	T946	
SC-160-8-40			8		7									12045	T947	
SC-160-10-40	10		9		1205		T948									
SC-160-12-40	12		11		1207		T9411									

* Use Zc (effective no. of teeth) to calculate the feed.
 * Fit Insert SNGW...R2.5 and R3.0, cutter have to modified (ask salesman).



Side Milling Cutters

- Inserts P. 242 - 244
- Cutting Data P. 248 - 249

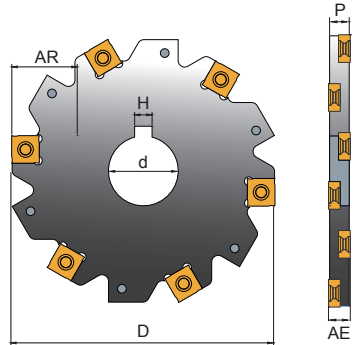

SC

Order Code	Dimensions (mm)						Z	Zc	KG	MAX. RPM	Inserts SNGX SNGW	Screw	Key			
	D	AE	AR	P	H	d										
SC-160-4-25.4	160	4	59.5	3.4	6.35	25.4	16	8	8300	1102	T9354	T09P				
SC-160-5-25.4		5		4.2						1103	T9355	T08P				
SC-160-6-25.4		6		5						1203	T945	T15P				
SC-160-7-25.4		7		6						1204	T946					
SC-160-8-25.4		8		7						12045	T947					
SC-160-10-25.4		10	9	1205	T948											
SC-160-12-25.4		12	11	1207	T9411											
SC-160-4-31.75		31.75	4	56.5	3.4	8				31.75	16	8	8300	1102	T9354	T09P
SC-160-5-31.75			5		4.2									1103	T9355	T08P
SC-160-6-31.75			6		5									1203	T945	T15P
SC-160-7-31.75	7		6		1204		T946									
SC-160-8-31.75	8		7		12045		T947									
SC-160-10-31.75	10		9		1205		T948									
SC-160-12-31.75	12		11		1207		T9411									

* Use Zc (effective no. of teeth) to calculate the feed.
 * Fit Insert SNGW...R2.5 and R3.0, cutter have to modified (ask salesman).

Side Milling Cutters

- Inserts P. 242 - 244
- Cutting Data P. 248 - 249

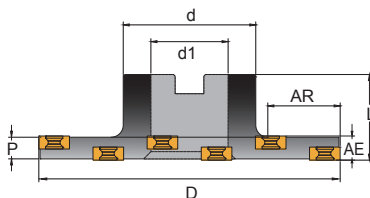

Slotting

ST

Order Code	Dimensions (mm)							Z	Zc	⚖️ KG	MAX. RPM	Inserts SNGX SNGW	Screw	Key		
	D	AE	AR	P	d	d1	L									
ST-80-6-22	80	6	17	5	40	22	8	4	0.47	13700	1203	T945	T15P			
ST-80-7-22		7		6										0.48	1204	T946
ST-80-8-22		8		7										0.49	12045	T947
ST-80-10-22		10		9										0.52	1205	T948
ST-80-12-22		12		11										0.55	1207	T9411
ST-100-6-27	100	6	27	5	35	27	10	5	0.56	12000	1203	T945				
ST-100-7-27		7		6										0.57	1204	T946
ST-100-8-27		8		7										0.59	12045	T947
ST-100-10-27		10		9										0.66	1205	T948
ST-100-12-27		12		11										0.72	1207	T9411
ST-125-6-32	125	6	31	5	55	32	12	6	0.96	10900	1203	T945				
ST-125-7-32		7		6									1.02	1204	T946	
ST-125-8-32		8		7									1.05	12045	T947	
ST-125-10-32		10		9									1.16	1205	T948	
ST-125-12-32		12		11									1.26	1207	T9411	
ST-160-6-32	160	6	48.5	5	8	16	8	1.42	8300	1203	T945					
ST-160-7-32		7		6								1.48	1204	T946		
ST-160-8-32		8		7								1.60	12045	T947		
ST-160-10-32		10		9								1.82	1205	T948		
ST-160-12-32		12		11								2.01	1207	T9411		

* Use Zc (effective no. of teeth) to calculate the feed.

* Fit Insert SNGW...R2.5 and R3.0, cutter have to modified (ask salesman).



Side Milling Cutters

- Inserts P. 242 - 244
- Cutting Data P. 248 - 249

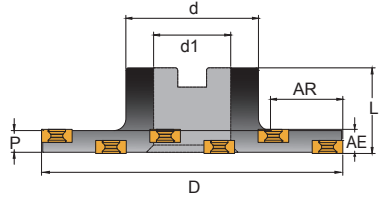

ST

Order Code	Dimensions (mm)							Z	Zc	KG	MAX. RPM	Inserts SNGX SNGW	Screw	Key
	D	AE	AR	P	d	d1	L							
ST-80-6-25.4	80	6	17	5	40	25.4	8	4	0.47	13700	1203	T945	T15P	
ST-80-7-25.4		7		6										
ST-80-8-25.4		8		7										
ST-80-10-25.4		10		9										
ST-80-12-25.4		12		11										
ST-100-6-25.4	100	6	27	5	35		10	5	0.56	12000	1203	T945		
ST-100-7-25.4		7		6										
ST-100-8-25.4		8		7										
ST-100-10-25.4		10		9										
ST-100-12-25.4		12		11										
ST-125-6-31.75	125	6	31	5	55	31.75	12	6	0.96	10900	1203	T945		
ST-125-7-31.75		7		6										
ST-125-8-31.75		8		7										
ST-125-10-31.75		10		9										
ST-125-12-31.75		12		11										
ST-160-6-31.75	160	6	48.5	5			16	8	1.42	8300	1203	T945		
ST-160-7-31.75		7		6										
ST-160-8-31.75		8		7										
ST-160-10-31.75		10		9										
ST-160-12-31.75		12		11										

* Use Zc (effective no. of teeth) to calculate the feed.

* Fit Insert SNGW...R2.5 and R3.0, cutter have to modified (ask salesman).

DISC MILLING CUTTER



Features

Available in materials



Cost
200~300%
SAVING

Applicable
Machines
Milling machine

Efficiency
300~500%
UP

Durability
300%
UP



PRODUCT SPECIFICATIONS

Disc Milling Cutters

- Inserts P. 245
- Cutting Data P. 250 - 251

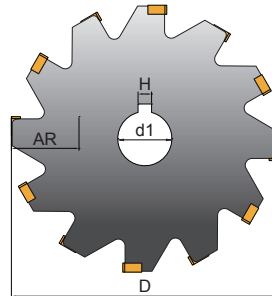

CE

Order Code	Dimensions (mm)						Z	Zc	KG	MAX. RPM	Inserts CNGX	Screw	Key
	D	AE	AR	P	H	d1							
CE080-14-22	80	14	22.5	12.5	6	22	8	4	0.45	13700	1005	C04011	T15P
CE080-16-22		16		14.5					0.51				
CE080-18-22		18		16.5					0.54				
CE080-20-22		20		18.5					0.59		1305		
CE080-22-22		22		20.5					0.69				
CE080-25-22		25		23.5					0.75				
CE080-30-22		30		28.5					0.88				
CE100-14-27	100	14	29.5	12.5	7	27	10	5	0.67	12000	1005		
CE100-16-27		16		14.5					0.76		1305		
CE100-18-27		18		16.5					0.84				

* Use Zc (effective no. of teeth) to calculate the feed.

Disc Milling Cutters

- Inserts P. 245
- Cutting Data P. 250 - 251

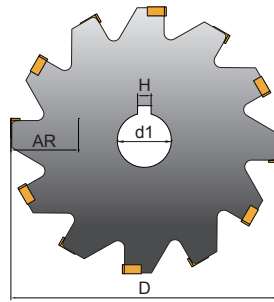

Slotting

CE

Order Code	Dimensions (mm)						Z	Zc	KG	MAX. RPM	Inserts CNGX	Screw	Key
	D	AE	AR	P	H	d1							
CE100-20-27	100	20	29.5	18.5	7	27	10	5	0.91	12000	1305	C04011	T15P
CE100-22-27		22		20.5					1.01				
CE100-25-27		25		23.5					1.16		1605		
CE100-30-27		30		28.5					1.40				
CE125-14-32	125	14	39	12.5	8	32	12	6	1.02	10900	1005		
CE125-16-32		16		14.5					1.17				
CE125-18-32		18		16.5					1.36				
CE125-20-32		20		18.5					1.52		1305		
CE125-22-32		22		20.5					1.57				
CE125-25-32		25		23.5					1.85		1605		
CE125-30-32	30	28.5	1.92										
CE080-14-25.4	80	14	19.5	12.5	6.35	25.4	8	4	0.45	13700	1005	C04011	T15P
CE080-16-25.4		16		14.5					0.51				
CE080-18-25.4		18		16.5					0.54		1305		
CE080-20-25.4		20		18.5					0.59				
CE080-22-25.4		22		20.5					0.69				

* Use Zc (effective no. of teeth) to calculate the feed.



Disc Milling Cutters

- Inserts P. 245
- Cutting Data P. 250 - 251

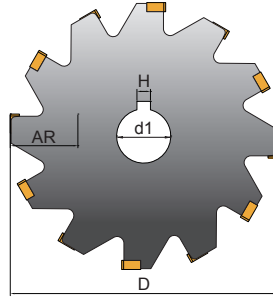

CE

Order Code	Dimensions (mm)						Z	Zc	KG	MAX. RPM	Inserts CNGX	Screw	Key	
	D	AE	AR	P	H	d1								
CE080-25-25.4	80	25	19.5	23.5	6.35	25.4	8	4	0.75	13700	1605	C04011	T15P	
CE080-30-25.4		30		28.5					0.88					
CE100-14-25.4	100	14	29.5	12.5			10	5	0.67	12000	1305			
CE100-16-25.4		16		14.5										0.76
CE100-18-25.4		18		16.5										0.84
CE100-20-25.4		20		18.5										0.91
CE100-22-25.4	22	20.5	1.01											
CE100-25-25.4	25	23.5	1.16											
CE100-30-25.4	30	28.5	1.40											
CE125-14-25.4	125	14	42	12.5			12	6	1.02	10900	1305			
CE125-16-25.4		16		14.5					1.17					
CE125-18-25.4		18		16.5					1.36					
CE125-20-25.4		20		18.5					1.52					
CE125-22-25.4		22		20.5					1.57					
CE125-25-25.4		25		23.5					1.85					
CE125-30-25.4		30		28.5					1.92					
														1605

* Use Zc (effective no. of teeth) to calculate the feed.

Disc Milling Cutters

- Inserts P. 245
- Cutting Data P. 250 - 251

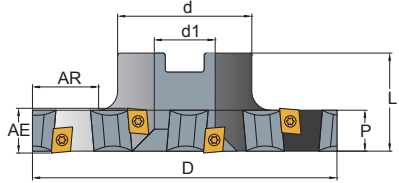

Slotting

CW

Order Code	Dimensions (mm)							Z	Zc	KG	MAX. RPM	Inserts CNGX	Screw	Key		
	D	AE	AR	P	d	d1	L									
CW080-14-22	80	14	17	12.5	40	22	35	8	4	0.67	13700	1005	C04011	T15P		
CW080-16-22		16		14.5						0.72						
CW080-18-22		18		16.5						0.76						
CW080-20-22		20		18.5						20.5		0.78			40	1605
CW080-22-22		22		20.5						0.79						
CW080-25-22		25		23.5						0.85						
CW080-30-22		30		28.5						0.92						
CW100-14-27	100	14	24.5	12.5	45	27	35	10	5	0.84	10900	1005	C04011	T15P		
CW100-16-27		16		14.5						0.94						
CW100-18-27		18		16.5						1.02						
CW100-20-27		20		18.5						20.5		1.09			40	1605
CW100-22-27		22		20.5						1.17						
CW100-25-27		25		23.5						1.25						
CW100-30-27		30		28.5						1.32						
CW125-14-32	125	14	32	12.5	55	32	35	12	6	1.42	10900	1005	C04011	T15P		
CW125-16-32		16		14.5						1.53						

* Use Zc (effective no. of teeth) to calculate the feed.



Disc Milling Cutters

- Inserts P. 245
- Cutting Data P. 250 - 251

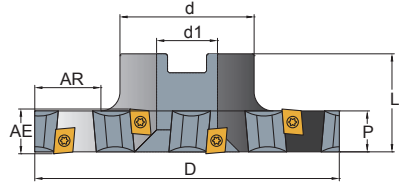

CW

Order Code	Dimensions (mm)							Z	Zc	KG	MAX. RPM	Inserts CNGX	Screw	Key
	D	AE	AR	P	d	d1	L							
CW125-18-32	125	18	32	16.5	55	32	35	12	6	1.68	10900	1305	C04011	T15P
CW125-20-32		20		18.5										
CW125-22-32		22		20.5										
CW125-25-32		25		23.5										
CW125-30-32		30		28.5			40							
CW080-14-25.4	80	14	17	12.5	40	25.4	35	8	4	0.67	13700	1005	C04011	T15P
CW080-16-25.4		16		14.5										
CW080-18-25.4		18		16.5										
CW080-20-25.4		20		18.5										
CW080-22-25.4		22		20.5										
CW080-25-25.4		25		23.5										
CW080-30-25.4		30		28.5			40							
CW100-14-25.4		100		14			24.5			12.5		45		
CW100-16-25.4	16		14.5											
CW100-18-25.4	18		16.5											
CW100-20-25.4	20		18.5											
														1305

* Use Zc (effective no. of teeth) to calculate the feed.

Disc Milling Cutters

- Inserts P. 245
- Cutting Data P. 250 - 251

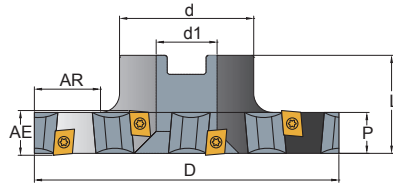

CW

Slotting

Order Code	Dimensions (mm)							Z	Zc	kg	MAX. RPM	Inserts CNGX	Screw	Key
	D	AE	AR	P	d	d1	L							
CW100-22-25.4	100	22	24.5	20.5	45	25.4	35	10	5	1.17	12000	1305	C04011	T15P
CW100-25-25.4		25		23.5			40			1.25		1605		
CW100-30-25.4		30		28.5			40			1.32		1605		
CW125-14-31.75	125	14	32	12.5	55	31.75	35	12	6	1.42	10900	1005		
CW125-16-31.75		16		14.5						1.53		1305		
CW125-18-31.75		18		16.5						1.68		1305		
CW125-20-31.75		20		18.5						1.92		1605		
CW125-22-31.75		22		20.5						1.94		1605		
CW125-25-31.75		25		23.5						1.96		1605		
CW125-30-31.75		30		28.5						2.29		1605		

* Use Zc (effective no. of teeth) to calculate the feed.



Mounting Dimensions

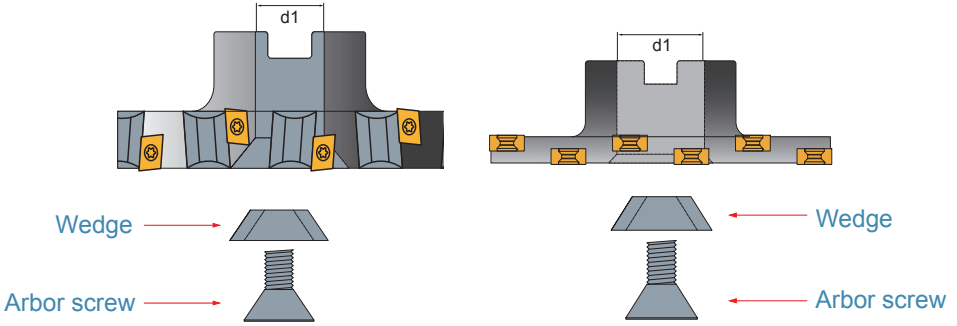

Dimension (mm)		
Cutter dimension d1	Arbor screw	Tapered Wedge
ST Ø 22	C901035	WE30
ST Ø 27	C901235	
ST Ø 32	C901635	WE45
ST Ø 25.4	C901235	WE30
ST Ø 31.75	C901635	WE45
CW Ø 22	C901035	WE30
CW Ø 27	C901235	
CW Ø 32	C901635	WE45
CW Ø 40	C901640	WE63
CW Ø 25.4	C901235	WE30
CW Ø 31.75	C901635	WE45
CW Ø 38.1	C901640	WE63
CW Ø 50.8		

* Cutter price includes the wedge.

BACK AND STRADDLE



Features

Available in materials



Cost
200~300%
SAVING

Applicable
Machines
Milling machine

Efficiency
300~500%
UP

Durability
300%
UP



PRODUCT SPECIFICATIONS

Back milling Cutters

- Inserts P. 245
- Cutting Data P. 250 - 251

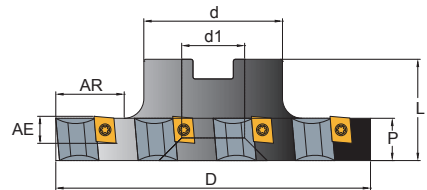
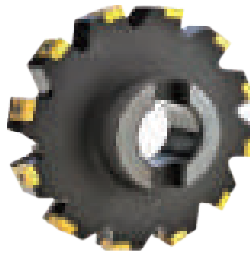
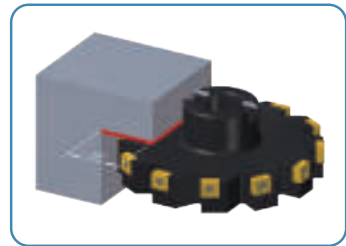

CB

Order Code	Dimensions (mm)							Z	 KG	MAX. RPM	Insert CNGX	Screw	Key
	D	AE	P	d	d1	L	AR						
CB-100-27	100	12	16.5	45	27	35	24.5	10	0.97	12000	1305	C04011	T15P
CB-125-32	125			55	32		32	12					

Straddle milling cutters

- Inserts P. 245
- Cutting Data P. 250 - 251

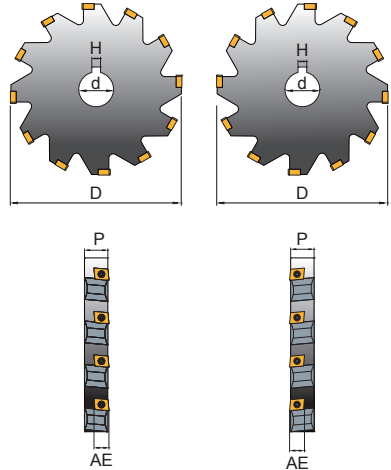

CDL / CDR

Order Code	Dimensions (mm)						Z	KG	MAX. RPM	Insert CNGX	Screw	Key						
	D	AE	P	d	H	L/R												
CDL-100-27	100	12	16.5	27	7	L	10	0.87	12000	1305	C04011	T15P						
CDR-100-27						R												
CDL-125-32	125					L							32	8	L	12	1.42	10900
CDR-125-32															R			
CDL-160-40	160			L	40	10	L	16	2.52				6900					
CDR-160-40							R											



SLITTING/ SLOTTING/ CUT-OFF SERIES Inserts

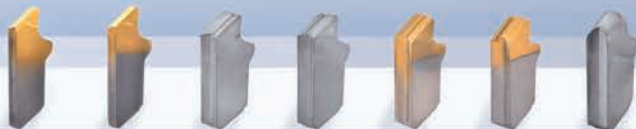

NRS / NLS

NR / NL

R

LNGT Inserts

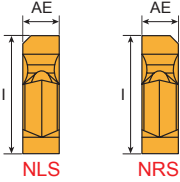

Tolerances (mm)
AE=±0.02

Inserts 10 PCS / Box

Dimensions (mm)		
Cutter thickness (P)	AE	I
1.2	1.4	9
1.2	1.5	
1.4	1.6	

Inserts	Order Code	Grades											
		Carbide					Cermet		Uncoated				
		B100	C200	C250	F20	F30	CE100	CE60	K10	CE			
NLS	LNLT 1414NLS-EE												Inserts Sequencing Position (Interleaving one after another different one.)
	LNLT 1415NLS-EE												
	LNLT 1616NLS-EE												
NRS	LNLT 1414NRS-EE												
	LNLT 1415NRS-EE												
	LNLT 1616NRS-EE												

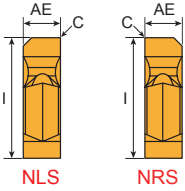

Tolerances (mm)
AE=±0.02

Inserts 10 PCS / Box

Dimensions (mm)			
Cutter thickness (P)	AE	I	C
1.2	1.4	9	0.03
1.2	1.5		
1.4	1.6		

Inserts	Order Code	Grades											
		Carbide					Cermet		Uncoated				
		B100	C200	C250	F20	F30	CE100	CE60	K10	CE			
NLS	LNLT 1414NLS-M												Inserts Sequencing Position (Interleaving one after another different one.)
	LNLT 1415NLS-M												
	LNLT 1616NLS-M												
	LNLT 1414NLS-ME	☉											
	LNLT 1415NLS-ME	☉											
	LNLT 1616NLS-ME	☉											
NRS	LNLT 1414NRS-M												
	LNLT 1415NRS-M												
	LNLT 1616NRS-M												
	LNLT 1414NRS-ME	☉											
	LNLT 1415NRS-ME	☉											
	LNLT 1616NRS-ME	☉											

- Steel Stainless Steel Steel/Stainless Steel /Super alloy Cast Iron Aluminum Steel/Cast Iron
- ☉ Steel/Stainless Steel/Cast Iron
- Prices and stocks are based on present conditions
- Please specify model numbers and the grade of inserts, ie: LNLT 1414NLS-M,B100



Insert

LNGT Inserts

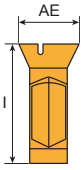

NLS

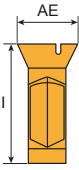

NRS

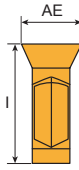



NS

Tolerances (mm)
AE=±0.02

← Only applicable
in cutter width
6,8mm

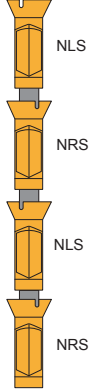
Dimensions (mm)		
Cutter thickness (P)	AE	I
1.6	1.8	9
1.75	2.0, 2.2, 2.5	
2.25	2.5, 2.7, 3.0	
2.7	3.0, 3.2, 3.5	
3.7	4.0, 4.2, 4.5	
4.5	5.0, 5.2, 5.5	

Inserts	Order Code	Grades											
		Carbide					Cermet		Uncoated				
		B100	C200	C250	F20	F30	CE100	CE60	K10		CE		
NLS	LNGT 1818NLS-EE												Inserts Sequencing Position 
	LNGT 2020NLS-EE												
	LNGT 2022NLS-EE												
	LNGT 2025NLS-EE												
	LNGT 2525NLS-EE												
	LNGT 2527NLS-EE												
	LNGT 2530NLS-EE												
	LNGT 3030NLS-EE												
	LNGT 3032NLS-EE												
	LNGT 3035NLS-EE												
	LNGT 4040NLS-EE												
	LNGT 4042NLS-EE												
	LNGT 4045NLS-EE												
	LNGT 5050NLS-EE												
LNGT 5052NLS-EE													
LNGT 5055NLS-EE													
NRS	LNGT 1818NRS-EE												(Interleaving one after another different one.) 
	LNGT 2020NRS-EE												
	LNGT 2022NRS-EE												
	LNGT 2025NRS-EE												
	LNGT 2525NRS-EE												
	LNGT 2527NRS-EE												
	LNGT 2530NRS-EE												
	LNGT 3030NRS-EE												
	LNGT 3032NRS-EE												
	LNGT 3035NRS-EE												
	LNGT 4040NRS-EE												
	LNGT 4042NRS-EE												
	LNGT 4045NRS-EE												
	LNGT 5050NRS-EE												
LNGT 5052NRS-EE													
LNGT 5055NRS-EE													
NS	LNGT 5050NS-EE												Inserts 10 PCS / Box

- Steel Stainless Steel Steel/Stainless Steel /Super alloy Cast Iron Aluminum Steel/Cast Iron Steel/Stainless Steel/Cast Iron
- Prices and stocks are based on present conditions
- Please specify model numbers and the grade of inserts, ie.: LNGT 2020NLS-EE, F20

LNGT Inserts

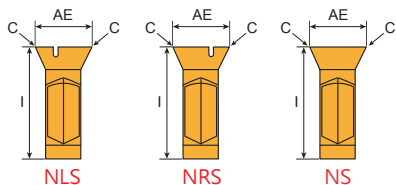

Tolerances (mm)
AE : ±0.02

Only applicable in cutter width 6,8mm

Dimensions (mm)			
Cutter thickness (P)	AE	I	C
1.6	1.8	9	0.05
1.75	2.0, 2.2, 2.5		
2.25	2.5, 2.7, 3.0		
2.7	3.0, 3.2, 3.5		
3.7	4.0, 4.2, 4.5		
4.5	5.0, 5.2, 5.5		

Inserts	Order Code	Grades										
		Carbide					Cermet		Uncoated			
		B100	C200	C250	F20	F30	CE100	CE60	K10		CE	
NLS	LNGT 1818NLS-M											<p>Inserts Sequencing Position</p> <p>(Interleaving one after another different one.)</p> <p>Inserts 10 PCS / Box</p>
	LNGT 2020NLS-M											
	LNGT 2022NLS-M											
	LNGT 2025NLS-M											
	LNGT 2525NLS-M											
	LNGT 2527NLS-M											
	LNGT 2530NLS-M											
	LNGT 3030NLS-M											
	LNGT 3032NLS-M											
	LNGT 3035NLS-M											
	LNGT 4040NLS-M											
	LNGT 4042NLS-M											
	LNGT 4045NLS-M											
	LNGT 5050NLS-M											
LNGT 5052NLS-M												
LNGT 5055NLS-M												
NRS	LNGT 1818NRS-M											
	LNGT 2020NRS-M											
	LNGT 2022NRS-M											
	LNGT 2025NRS-M											
	LNGT 2525NRS-M											
	LNGT 2527NRS-M											
	LNGT 2530NRS-M											
	LNGT 3030NRS-M											
	LNGT 3032NRS-M											
	LNGT 3035NRS-M											
	LNGT 4040NRS-M											
	LNGT 4042NRS-M											
	LNGT 4045NRS-M											
	LNGT 5050NRS-M											
LNGT 5052NRS-M												
LNGT 5055NRS-M												
NS	LNGT 5050NS-M											

- Steel Stainless Steel Steel/Stainless Steel /Super alloy Cast Iron Aluminum Steel/Cast Iron Steel/Stainless Steel/Cast Iron
- Prices and stocks are based on present conditions
- Please specify model numbers and the grade of inserts, ie.: LNGT 2020NLS-M,B100



Insert

LNGT Inserts

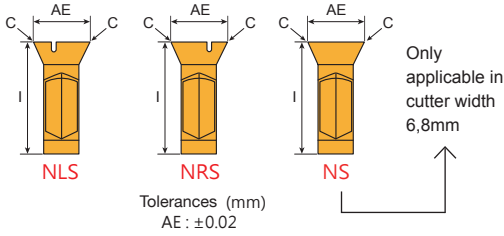

Dimensions (mm)			
Cutter thickness (P)	AE	I	C
1.6	1.8	9	0.05
1.75	2.0, 2.2, 2.5		
2.25	2.5, 2.7, 3.0		
2.7	3.0, 3.2, 3.5		
3.7	4.0, 4.2, 4.5		
4.5	5.0, 5.2, 5.5		

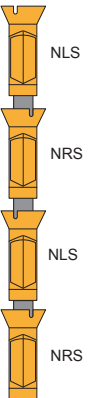
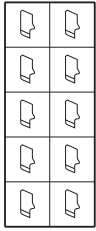
Inserts	Order Code	Grades										
		Carbide					Cermet		Uncoated			
		B100	C200	C250	F20	F30	CE100	CE60	K10		CE	
NLS	LNGT 1818NLS-ME	⊙										Inserts Sequencing Position 
	LNGT 2020NLS-ME	⊙										
	LNGT 2022NLS-ME	⊙										
	LNGT 2025NLS-ME	⊙										
	LNGT 2525NLS-ME	⊙										
	LNGT 2527NLS-ME	⊙										
	LNGT 2530NLS-ME	⊙										
	LNGT 3030NLS-ME	⊙										
	LNGT 3032NLS-ME	⊙										
	LNGT 3035NLS-ME	⊙										
	LNGT 4040NLS-ME	⊙										
	LNGT 4042NLS-ME	⊙										
	LNGT 4045NLS-ME	⊙										
LNGT 5050NLS-ME	⊙											
LNGT 5052NLS-ME	⊙											
LNGT 5055NLS-ME	⊙											
NRS	LNGT 1818NRS-ME	⊙										(Interleaving one after another different one.) 
	LNGT 2020NRS-ME	⊙										
	LNGT 2022NRS-ME	⊙										
	LNGT 2025NRS-ME	⊙										
	LNGT 2525NRS-ME	⊙										
	LNGT 2527NRS-ME	⊙										
	LNGT 2530NRS-ME	⊙										
	LNGT 3030NRS-ME	⊙										
	LNGT 3032NRS-ME	⊙										
	LNGT 3035NRS-ME	⊙										
	LNGT 4040NRS-ME	⊙										
	LNGT 4042NRS-ME	⊙										
	LNGT 4045NRS-ME	⊙										
LNGT 5050NRS-ME	⊙											
LNGT 5052NRS-ME	⊙											
LNGT 5055NRS-ME	⊙											
NS	LNGT 5050NS-ME	⊙										

- Steel Stainless Steel Steel/Stainless Steel /Super alloy Cast Iron Aluminum Steel/Cast Iron Steel/Stainless Steel/Cast Iron
- Prices and stocks are based on present conditions
- Please specify model numbers and the grade of inserts, ie.: LNGT 2020NLS-ME,B100

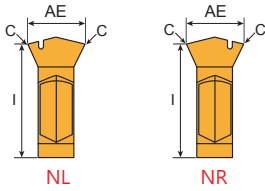

LNGT Inserts



V shape insert designed for superior stability and durability

Tolerances (mm)
AE : ±0.02

Dimensions (mm)			
Cutter thickness (P)	AE	I	C
1.75	2.0	9	0.05
	2.2		
	2.5		
2.25	2.5		
	2.7		
	3.0		
2.7	3.0		
	3.2		
	3.5		
3.7	4.0		
	4.2		
	4.5		
4.5	5.0		
	5.2		
	5.5		

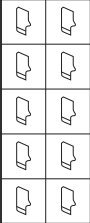
Inserts	Order Code	Grades												
		Carbide					Cermets		Uncoated					
		B100	C200	C250	F20	F30	CE100	CE60	K10	CE				
NL	LNGT 2020NL-M													Inserts Sequencing Position  (Interleaving one after another different one.) 
	LNGT 2022NL-M													
	LNGT 2025NL-M													
	LNGT 2525NL-M													
	LNGT 2527NL-M													
	LNGT 2530NL-M													
	LNGT 3030NL-M													
	LNGT 3032NL-M													
	LNGT 3035NL-M													
	LNGT 4040NL-M													
	LNGT 4042NL-M													
	LNGT 4045NL-M													
	LNGT 5050NL-M													
LNGT 5052NL-M														
LNGT 5055NL-M														
NR	LNGT 2020NR-M													
	LNGT 2022NR-M													
	LNGT 2025NR-M													
	LNGT 2525NR-M													
	LNGT 2527NR-M													
	LNGT 2530NR-M													
	LNGT 3030NR-M													
	LNGT 3032NR-M													
	LNGT 3035NR-M													
	LNGT 4040NR-M													
	LNGT 4042NR-M													
	LNGT 4045NR-M													
	LNGT 5050NR-M													
LNGT 5052NR-M														
LNGT 5055NR-M														

- Steel Stainless Steel Steel/Stainless Steel /Super alloy Cast Iron Aluminum Steel/Cast Iron Steel/Stainless Steel/Cast Iron
- Prices and stocks are based on present conditions
- Please specify model numbers and the grade of inserts, ie.: LNGT 2020NL-M, B100



Insert

LNGT Inserts

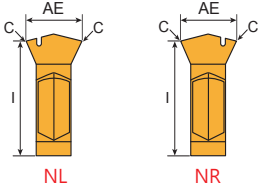

Tolerances (mm)
AE : ±0.02

Dimensions (mm)			
Cutter thickness(P)	AE	I	C
1.75	2.0	9	0.05
	2.2		
	2.5		
2.25	2.5		
	2.7		
	3.0		
2.7	3.0		
	3.2		
	3.5		
3.7	4.0		
	4.2		
	4.5		
4.5	5.0		
	5.2		
	5.5		

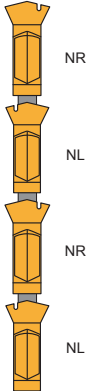
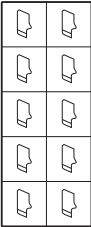
Inserts	Order Code	Grades										
		Carbide					Cermet		Uncoated			
		B100	C200	C250	F20	F30	CE100	CE60	K10	CE		
NL	LNGT 2020NL-ME	⊙										Inserts Sequencing Position 
	LNGT 2022NL-ME	⊙										
	LNGT 2025NL-ME	⊙										
	LNGT 2525NL-ME	⊙										
	LNGT 2527NL-ME	⊙										
	LNGT 2530NL-ME	⊙										
	LNGT 3030NL-ME	⊙										
	LNGT 3032NL-ME	⊙										
	LNGT 3035NL-ME	⊙										
	LNGT 4040NL-ME	⊙										
	LNGT 4042NL-ME	⊙										
	LNGT 4045NL-ME	⊙										
	LNGT 5050NL-ME	⊙										
LNGT 5052NL-ME	⊙											
LNGT 5055NL-ME	⊙											
NR	LNGT 2020NR-ME	⊙										(Interleaving one after another different one.) 
	LNGT 2022NR-ME	⊙										
	LNGT 2025NR-ME	⊙										
	LNGT 2525NR-ME	⊙										
	LNGT 2527NR-ME	⊙										
	LNGT 2530NR-ME	⊙										
	LNGT 3030NR-ME	⊙										
	LNGT 3032NR-ME	⊙										
	LNGT 3035NR-ME	⊙										
	LNGT 4040NR-ME	⊙										
	LNGT 4042NR-ME	⊙										
	LNGT 4045NR-ME	⊙										
	LNGT 5050NR-ME	⊙										
LNGT 5052NR-ME	⊙											
LNGT 5055NR-ME	⊙											

- Steel Stainless Steel Steel/Stainless Steel /Super alloy Cast Iron Aluminum Steel/Cast Iron
- Steel/Stainless Steel/Cast Iron
- Prices and stocks are based on present conditions
- Please specify model numbers and the grade of inserts, ie.: LNGT 2020NL-ME,B100

SNGX Inserts

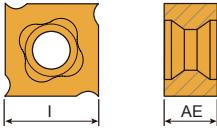

Tolerances (mm)
I=±0.025 AE=±0.025

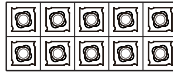

Inserts 10 PCS / Box

Dimensions (mm)		
Insert Code	AE	I
1102	2.3	11.0
1103	2.7	
1203	3.2	12.7
1204	4.0	
12045	4.5	
1205	5.4	
1207	7.0	

Inserts	Order Code	Cutting Rate	Grades									
			Carbide					Cermet		Uncoated		
			B100	C200	C250	F20	F30	CE100	CE60	K10	CE	
 E / ME / M	SNGX 1102-E	25 °										
	SNGX 1103-E											
	SNGX 1203-E											
	SNGX 1204-E											
	SNGX 12045-E											
	SNGX 1205-E											
	SNGX 1207-E											
	SNGX 1102-ME	15 °	⊗									
	SNGX 1103-ME		⊗									
	SNGX 1203-ME		⊗									
	SNGX 1204-ME		⊗									
	SNGX 12045-ME		⊗									
	SNGX 1205-ME		⊗									
	SNGX 1207-ME	⊗										
	SNGX 1102T-M	15 °										
	SNGX 1103T-M											
	SNGX 1203T-M											
	SNGX 1204T-M											
	SNGX 12045T-M											
	SNGX 1205T-M											
	SNGX 1207T-M											

- Steel Stainless Steel Steel/Stainless Steel /Super alloy Cast Iron Aluminum Steel/Cast Iron
- ⊗ Steel/Stainless Steel/Cast Iron
- Prices and stocks are based on present conditions
- Please specify model numbers and the grade of inserts, ie.: SNGX 1102-E,F20

SNGW Inserts

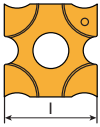

Tolerances (mm)
I=±0.025 AE=±0.025

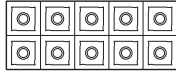

Inserts 10 PCS / Box

Dimensions (mm)		
Insert Code	AE	I
1102	2.3	11.0
1103	2.7	
1203	3.2	
1204	4.0	12.7
12045	4.5	
1205	5.4	
1207	7.0	

Inserts	Order Code	Cutting Rake	Grades									
			Carbide					Cermet		Uncoated		
			B100	C200	C250	F20	F30	CE100	CE60	K10	CE	
 E / ME / M	SNGW 1102-E	25°										
	SNGW 1103-E											
	SNGW 1203-E											
	SNGW 1204-E											
	SNGW 12045-E											
	SNGW 1205-E											
	SNGW 1207-E											
	SNGW 1102-ME	15°	⊙									
	SNGW 1103-ME		⊙									
	SNGW 1203-ME		⊙									
	SNGW 1204-ME		⊙									
	SNGW 12045-ME		⊙									
	SNGW 1205-ME		⊙									
	SNGW 1207-ME	⊙										
	SNGW 1102T-M	15°	■									
	SNGW 1103T-M		■									
	SNGW 1203T-M		■									
	SNGW 1204T-M		■									
	SNGW 12045T-M		■									
	SNGW 1205T-M		■									
	SNGW 1207T-M		■									

- Steel ■ Stainless Steel ⊙ Steel/Stainless Steel /Super alloy ■ Cast Iron ■ Aluminum ■ Steel/Cast Iron
- ⊙ Steel/Stainless Steel/Cast Iron
- Prices and stocks are based on present conditions
- Please specify model numbers and the grade of inserts, ie.: SNGW 1102-E,F20

Insert



SNGW Inserts - R0.4~R3.0

* Fit Insert SNGW...R2.5 and R3.0, cutter have to modified (ask salesman).

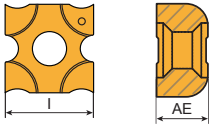

Tolerances (mm)
I=±0.025 AE=±0.025

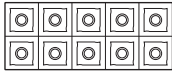

Inserts 10 PCS / Box

Dimensions (mm)				Dimensions (mm)			
Insert Code	AE	I	R	Inserts Code	AE	I	R
1102	2.3	11.0	0.4	12045	4.5	12.7	1.6
1102			0.8	12045			2.0
1103			0.4	1205			0.4
1103	2.7	11.0	0.8	1205	5.4	12.7	0.8
1203			0.4	1205			1.2
1203	3.2	12.7	0.8	1205	7.0	12.7	1.6
1203			1.2	1205			2.0
1204			0.4	1207			2.5
1204	4.0	12.7	0.8	1207	7.0	12.7	0.4
1204			1.2	1207			0.8
1204			1.6	1207			1.2
12045	4.5	12.7	0.4	1207	7.0	12.7	1.6
12045			0.8	1207			2.0
12045			1.2	1207			2.5
				1207			3.0

Inserts	Order Code	Cutting Rake	Grades											
			Carbide					Cermet		Uncoated				
			B100	C200	C250	F20	F30	CE100	CE60	K10	CE			
 ME	SNGW 1102R04-ME	15°	⊙											
	SNGW 1102R08-ME		⊙											
	SNGW 1103R04-ME		⊙											
	SNGW 1103R08-ME		⊙											
	SNGW 1203R04-ME		⊙											
	SNGW 1203R08-ME		⊙											
	SNGW 1203R12-ME		⊙											
	SNGW 1204R04-ME		⊙											
	SNGW 1204R08-ME		⊙											
	SNGW 1204R12-ME		⊙											
	SNGW 1204R16-ME		⊙											
	SNGW 12045R04-ME		⊙											
	SNGW 12045R08-ME		⊙											
	SNGW 12045R12-ME		⊙											
	SNGW 12045R16-ME		⊙											
	SNGW 12045R20-ME		⊙											
	SNGW 1205R04-ME		⊙											
	SNGW 1205R08-ME		⊙											
	SNGW 1205R12-ME		⊙											
	SNGW 1205R16-ME		⊙											
	SNGW 1205R20-ME		⊙											
	SNGW 1205R25-ME		⊙											
	SNGW 1207R04-ME		⊙											
	SNGW 1207R08-ME		⊙											
	SNGW 1207R12-ME		⊙											
	SNGW 1207R16-ME		⊙											
	SNGW 1207R20-ME		⊙											
	SNGW 1207R25-ME		⊙											
SNGW 1207R30-ME	⊙													

- Steel Stainless Steel Steel/Stainless Steel /Super alloy Cast Iron Aluminum Steel/Cast Iron
- Steel/Stainless Steel/Cast Iron
- Prices and stocks are based on present conditions
- Please specify model numbers and the grade of inserts, ie.: SNGW 1102R04-ME,F20

CNGX Inserts

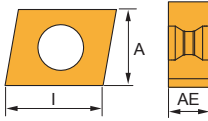

Tolerances (mm)

I=±0.025 AE=±0.025 A=±0.025

Dimensions (mm)			
Insert Code	AE	I	A
1005	5.4	10.0	10
1305		12.7	
1605		16.0	

Inserts	Order Code	Grades										
		Carbide					Cermet	Uncoated				
		B100	C200	C250	F20	F30	CE100	CE60		K10		CE
	CNGX 1005-E											
	CNGX 1305-E											
	CNGX 1605-E											
	CNGX 1005-ME	⊗										
	CNGX 1305-ME	⊗										
	CNGX 1605-ME	⊗										
	CNGX 1005T-M											
	CNGX 1305T-M											
	CNGX 1605T-M											

Inserts 10 PCS / Box

- Steel Stainless Steel Steel/Stainless Steel /Super alloy Cast Iron Aluminum Steel/Cast Iron Steel/Stainless Steel/Cast Iron
- Prices and stocks are based on present conditions
- Please specify model numbers and the grade of inserts, ie.: CNGX 1005-E,F20

Recommendation-LNGT Inserts

LNGT Insert Grade Selection

Material group	Recom. fz (mm/tooth)	Inserts			
		LNGT ... M	LNGT...ME	LNGT...EE	
1	0.04-0.12	B100	B100	-	-
2	0.04-0.10	B100	B100	-	-
3	0.04-0.10	B100	B100	-	-
4	0.04-0.10	B100	B100	-	-
5	0.04-0.08	B100	B100	-	-
6	0.04-0.07	B100	B100	-	-
7	0.03-0.06	-	B100	-	-
8	0.04-0.12	-	B100	-	-
9	0.04-0.10	-	B100	-	-
10	0.04-0.09	-	B100	-	-
11	0.04-0.08	-	B100	-	-
12	0.04-0.12	-	F20	-	-
13	0.04-0.12	-	F20	-	-
14	0.04-0.11	-	F20	-	-
15	0.04-0.10	-	F20	-	-
16	0.06-0.13	-	-	F20	-
17	0.06-0.12	-	-	F20	-
18	0.06-0.11	-	-	F20	-
19	0.06-0.09	-	B100	-	-
20	0.06-0.08	-	B100	-	-
21	0.04-0.06	-	B100	-	-
22	0.04-0.07	-	B100	-	-



Insert

Recommendation-LNGT Inserts

• LNGT Insert Recommended Cutting speed, Vc(m/min)

Material group	Grades						
	B100	C250	F20	CE60	CE	K10	F30
	fz (mm/tooth)						
	0.03 0.05 0.08		0.05 0.09 0.13				
Cutting speed, Vc (m/min)							
1	215 195 168	-	-	-	-	-	-
2	168 151 135	-	-	-	-	-	-
3	151 135 122	-	-	-	-	-	-
4	134 122 109	-	-	-	-	-	-
5	121 109 97	-	-	-	-	-	-
6	109 - -	-	-	-	-	-	-
7	- - -	-	-	-	-	-	-
8	160 - 80	-	-	-	-	-	-
9	160 - 80	-	-	-	-	-	-
10	80 - 50	-	-	-	-	-	-
11	80 - 50	-	-	-	-	-	-
12	-	-	168 142 126	-	-	-	-
13	-	-	151 126 117	-	-	-	-
14	-	-	134 117 109	-	-	-	-
15	-	-	105 97 -	-	-	-	-
16	-	-	1150 950 850	-	-	-	-
17	-	-	950 780 700	-	-	-	-
18	-	-	950 780 700	-	-	-	-
19	50 45 -	-	-	-	-	-	-
20	50 45 -	-	-	-	-	-	-
21	35 40 -	-	-	-	-	-	-
22	50 45 -	-	-	-	-	-	-

• Type Of Inserts

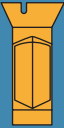
	Insert Code	Width of slot (mm)
	1414	1.4
	2020	2.0
	2525	2.5
	3030	3.0
	4040	4.0
	5050	5.0

Recommendation-LNGT Inserts

f_z (mm / thoooh)

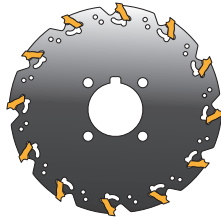

• f_z (mm/tooth)

 AE	f_z (mm/tooth)					
	Material group					
	1 2 3 4	5 6	8 9 10 11	12 13 14 15	16 17 18	19 20 21 22
1.4-1.7 mm	0.02-0.03	0.015-0.025	0.03-0.04	0.02-0.04	0.02-0.04	0.015-0.025
1.8-2.2 mm	0.03-0.05	0.03-0.04	0.03-0.04	0.03-0.06	0.03-0.08	0.02-0.03
2.5-3.0 mm	0.03-0.06	0.03-0.05	0.02-0.03	0.03-0.08	0.03-0.1	0.03-0.04
3.0-3.5 mm	0.04-0.08	0.03-0.06	0.03-0.06	0.04-0.1	0.04-0.1	0.03-0.05
4.0-4.5 mm						
5.0-5.5 mm	0.05-0.1	0.04-0.08	0.04-0.07	0.05-0.12	0.05-0.17	0.04-0.06

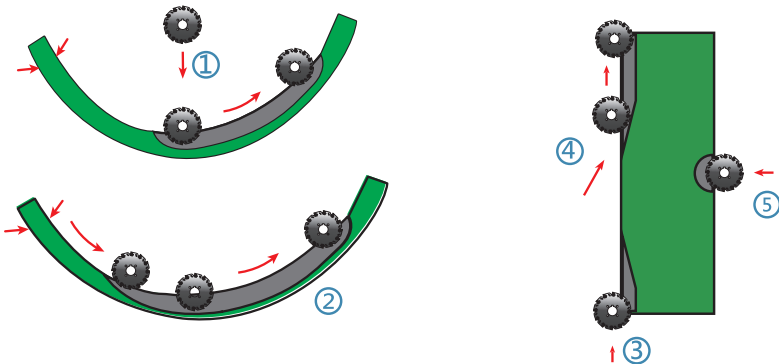

- ① Plunging to mill : F_z reduce to 50%
- ② Ramping to mill : F_z remain 100%
- ③ Mill : F_z remain 100%
- ④ Ramping : F_z remain 100%
- ⑤ Plunging to mill : F_z reduce to 50%



Recommendation-SNGX / SNGW Inserts

• SNGX / SNGW Insert Grade Selection

Material group	Recom. fz (mm/tooth)	Inserts			
		SNGX ... M SNGW ...M	SNGX ... ME SNGW ... ME	SNGX ... EE SNGW ... EE	
1	0.14-0.30	C250/B100	B100	-	-
2	0.14-0.25	C250/B100	B100	-	-
3	0.14-0.22	C250/B100	B100	-	-
4	0.14-0.22	C250/B100	B100	-	-
5	0.14-0.20	C250/B100	B100	-	-
6	0.10-0.15	C250/B100	B100	-	-
7	0.10-0.13	C250/B100	B100	-	-
8	0.14-0.25	-	B100	-	-
9	0.14-0.22	-	B100	-	-
10	0.14-0.20	-	B100	-	-
11	0.10-0.15	-	B100	-	-
12	0.14-0.30	-	F30	-	-
13	0.14-0.22	-	F30	-	-
14	0.14-0.20	-	F30	-	-
15	0.10-0.15	-	F30	-	-
16	0.16-0.30	-	-	F20	-
17	0.16-0.25	-	-	F20	-
18	0.16-0.20	-	-	F20	-
19	0.14-0.20	-	B100	-	-
20	0.14-0.18	-	B100	-	-
21	0.10-0.13	-	B100	-	-
22	0.14-0.20	-	B100	-	-

Recommendation-SNGX / SNGW Inserts

• Recommended Cutting Speed, Vc(m/min)

Material group	Grades														
	B100			C250			F20			CE60	CE	K10	F30		
	fz (mm/tooth)														
	0.1	0.2	0.3	0.1	0.2	0.3	0.1	0.2	0.3				0.1	0.2	0.3
Cutting Speed, Vc (m/min)															
1	186	166	150	166	146	130	-	-	-	-	-	-	-	-	
2	168	150	135	148	130	115	-	-	-	-	-	-	-	-	
3	151	136	122	131	116	102	-	-	-	-	-	-	-	-	
4	136	122	110	116	102	90	-	-	-	-	-	-	-	-	
5	120	110	99	100	90	79	-	-	-	-	-	-	-	-	
6	92	78	-	72	58	-	-	-	-	-	-	-	-	-	
7	-	-	-	-	-	-	-	-	-	-	-	-	-	-	
8	160	-	80	-	-	-	-	-	-	-	-	-	-	-	
9	160	-	80	-	-	-	-	-	-	-	-	-	-	-	
10	80	-	50	-	-	-	-	-	-	-	-	-	-	-	
11	80	-	50	-	-	-	-	-	-	-	-	-	-	-	
12	-	-	-	-	-	-	-	-	-	-	-	140	119	105	
13	-	-	-	-	-	-	-	-	-	-	-	126	105	98	
14	-	-	-	-	-	-	-	-	-	-	-	119	98	91	
15	-	-	-	-	-	-	-	-	-	-	-	91	88	-	
16	-	-	-	-	-	-	1150	950	850	-	-	-	-	-	
17	-	-	-	-	-	-	950	780	700	-	-	-	-	-	
18	-	-	-	-	-	-	950	780	700	-	-	-	-	-	
19	55	45	-	-	-	-	-	-	-	-	-	-	-	-	
20	55	45	-	-	-	-	-	-	-	-	-	-	-	-	
21	46	38	-	-	-	-	-	-	-	-	-	-	-	-	
22	55	45	-	-	-	-	-	-	-	-	-	-	-	-	

• Type Of Inserts

Insert Code	Width of slot (mm)
1203	6
1204	7
12045	8
1205	10
1207	12



Recommendation - CNGX Inserts

• CNGX Insert Grade Selection

Material group	Recom. fz (mm/tooth)	Inserts			
		CNGX ... M	CNGX...ME	CNGX...E	
1	0.2-0.4	C250/B100	B100	-	-
2		C250/B100	B100	-	-
3	0.2-0.35	C250/B100	B100	-	-
4		C250/B100	B100	-	-
5	0.2-0.32	C250/B100	B100	-	-
6		C250/B100	B100	-	-
7	0.15-0.3	C250/B100	B100	-	-
8	0.2-0.4	-	B100	-	-
9		-	B100	-	-
10	0.2-0.33	-	B100	-	-
11		-	B100	-	-
12	0.22-0.4	-	F30	-	-
13		-	F30	-	-
14	0.2-0.35	-	F30	-	-
15		-	F30	-	-
16	0.22-0.42	-	-	F20	-
17		-	-	F20	-
18		-	-	F20	-
19	0.2-0.3	-	B100	-	-
20		-	B100	-	-
21	0.15-0.25	-	B100	-	-
22	0.2-0.25	-	B100	-	-

• Recommended Cutting Speed, Vc(m/min)

Material group	Grades									
	B100		C250		F20		CE60	CE	K10	F30
	fz (mm/tooth)									
	0.1 0.2 0.3		0.1 0.2 0.3		0.1 0.2 0.3					
Cutting Speed, Vc (m/min)										
1	162	140	123	162	140	123	-	-	-	-
2	146	123	105	146	123	105	-	-	-	-
3	120	101	92	120	101	92	-	-	-	-
4	109	92	84	109	92	84	-	-	-	-
5	90	78	70	90	78	70	-	-	-	-
6	63	56	-	64	56	-	-	-	-	-
7	-	-	-	28	-	-	-	-	-	-
8	160	-	70	-	-	-	-	-	-	-
9	160	-	70	-	-	-	-	-	-	-
10	80	-	50	-	-	-	-	-	-	-
11	80	-	50	-	-	-	-	-	-	-
12	-	-	-	-	-	-	-	-	-	-
13	-	-	-	-	-	-	-	-	-	140 119 105
14	-	-	-	-	-	-	-	-	-	126 105 98
15	-	-	-	-	-	-	-	-	-	119 98 91
16	-	-	-	-	-	-	-	-	-	91 84 -
17	-	-	-	-	-	-	805 665 595	-	-	-
18	-	-	-	-	-	-	665 549 490	-	-	-
19	40	37	-	-	-	-	-	-	-	-
20	40	37	-	-	-	-	-	-	-	-
21	35	30	-	-	-	-	-	-	-	-
22	40	37	-	-	-	-	-	-	-	-

Insert

• Type Of Inserts

	Insert Code	Width of slot (mm)
	1005	14-16
	1305	18-24
	1605	25-30



CENTER SERIES

- CENTER/SPOT DRILL IN MILLING AND TURNING



PATENTED

Features Description

The precise eccentricity only $\pm 0.008\text{mm}$ enhances the tool life of taps and drills, Special carbide inserts with unique geometry improve the strength of insert tip.

Center Drill: $\varnothing 1.6 - \varnothing 8 \text{ mm}$

Spot Drill: $\varnothing 8 - \varnothing 16 \text{ mm}$



SPOT DRILL - 390 SYSTEM

PATENTED



Video

Features

Available in
materials



Cost
300~500%
SAVING

Applicable
Machines

Milling / Turning /
Drilling

Efficiency
300%
UP

Durability
300%
UP

Design

Center point eccentricity $\pm 0.008\text{mm}$

1. Plug-and-clamp self-centering design

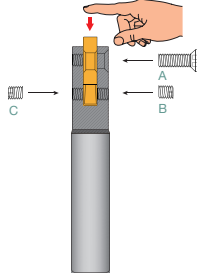

2. Back taper

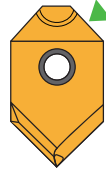

Gives awesome stabilities that conduces to excellent verticality precision.

Product Introduction



Spot Drill

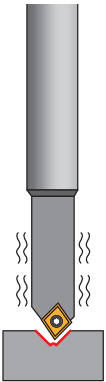

Big eccentricity tolerance minimum $\pm 0.3\text{ mm}$

1. To use this kind of chamfer tool for centering processes is likely break drills and taps often.
2. This chamfer tool works with single flute only, it performs low speed.

23 Inserts

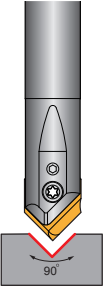

90

A23 Inserts

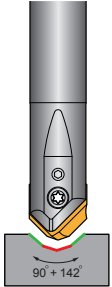

90 + 142

B23 Inserts

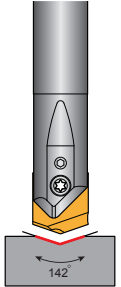

142

Subtle eccentricity tolerance maximum is $\pm 0.008\text{ mm}$

1. Designed with chip breaking teeth both on the front and back side of indexable inserts.
2. The most popular spot drill which has 45° chamfer angle and suitable in various applications: such as spot positioning, V-shape grooving and engraving.
3. Can also be used in round-hole and side corner chamfering with 2 effective flutes.

1. Designed with two point angles 90° + 142°.
2. It performs 45° chamfering and 142° spot positioning in one step.

142° point angle is perfect for all different size of drills.



Operations prior to small / long depth drills and Tapping

Imprecise spot drills

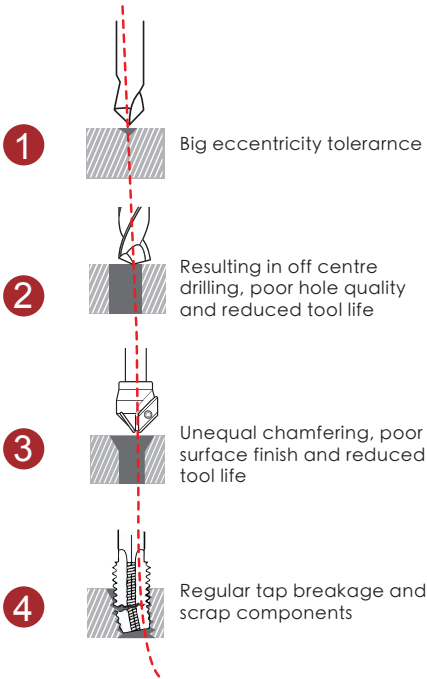

Y.T. accurate spot drills

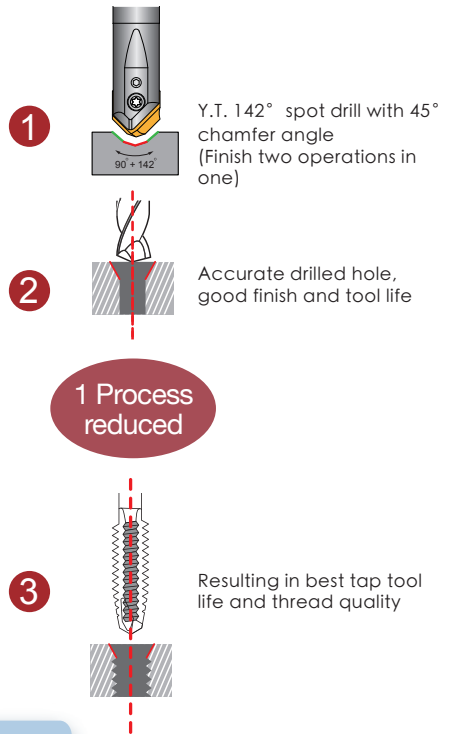

Y.T. 90° Spot Drill With Multipurpose Function

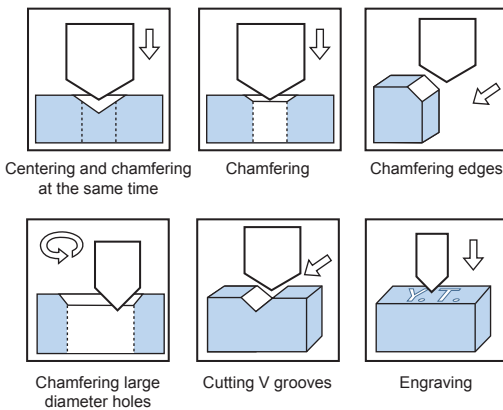

Can be used in M/C and drilling machine



PRODUCT SPECIFICATIONS

Spot Drill Toolholders

- Inserts P. 258 - 259
- Cutting Data P. 260 - 264

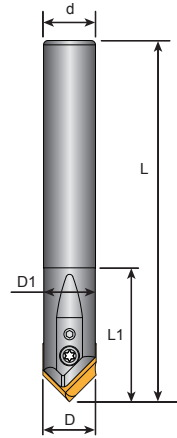

Spot Drill

13

Order Code	Dimensions (mm)						KG	Inserts 23 A23 B23	Screw	Key
	D	D1	d	L	L1	L2				
13-0808-60	8	7.9	8	60	20		0.06	0802	C02506 S025025	T08P L013
13-0808-85				85			0.07			
13-1008-60				60			0.09			
13-1010-65	10	9.9	10	65	20		0.09	1002	C03008 S02503	T09P L013
13-1010-100				100			0.12			
13-1010-150				150			0.12			
13-1210-65	12	11.9	12	65	30		0.12	1203	C03010 S0304	T09P L015
13-1212-80				80			0.15			
13-1212-110				110			0.18			
13-1212-160	12	11.9	12	160	30		0.21	1603	C03512 S0405	T10P L02
13-1612-80				80			0.21			
13-1616-100				100			0.26			
13-1616-130	16	15.8	16	130	35		0.26	1603	C03512 S0405	T10P L02
13-1616-180				180			0.36			



23 Inserts

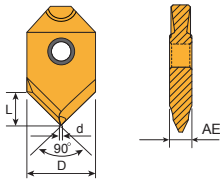

Tolerances (mm)

AE : + 0.01
- 0.02

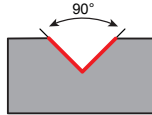

Dimensions (mm)				
D	d	L	AE	angle
8	0.7	4	2.0	90°
10	0.8	5	2.5	
12	0.9	6	3.0	
16	1.0	8	3.0	

Inserts	Order Code	Grades											
		Carbide					Cermet		Uncoated				
		Cl25	B350	C350	F20	F30	CE25	CE100	CE60	K10		CE	
	23-0802-90-E												 Inserts 10 PCS / Box
	23-1002-90-E												
	23-1203-90-E												
	23-1603-90-E												
	23-0802-90-ME		⊙	⊙									
23-1002-90-ME		⊙	⊙										
23-1203-90-ME		⊙	⊙										
23-1603-90-ME		⊙	⊙										

A23 Inserts

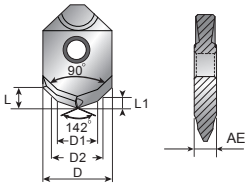

Tolerances (mm)

AE : + 0.01
- 0.02

Chamfering application

Spot application

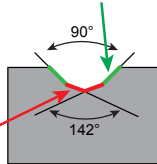

Dimensions (mm)							
D	L	D1	D2	L1	AE	M	angle
8	2.8	3.3	4.2	1.02	2.0	M4 x 0.7	90° 142°
10	3.5	4.2	5.25	1.25	2.5	M5 x 0.8	
12	4.2	5.0	6.3	1.55	3.0	M6 x 1.0	
16	5.6	6.8	8.4	1.97	3.0	M8 x 1.25	
16	5.1	8.5	10.5	2.46	3.0	M10 x 1.5	

Inserts	Order Code	Grades											
		Carbide					Cermet		Uncoated				
		Cl25	B350	C350	F20	F30	CE25	CE100	CE60	K10		CE	
	A23-0802-M4-ME		⊙										 Inserts 10 PCS / Box
	A23-1002-M5-ME		⊙										
	A23-1203-M6-ME		⊙										
	A23-1603-M8-ME		⊙										
	A23-1603-M10-ME		⊙										

- Steel Stainless Steel Steel/Stainless Steel /Super alloy Cast Iron Aluminum Steel/Cast Iron
- Steel/Stainless Steel/Cast Iron
- Prices and stocks are based on present conditions
- Please specify model numbers and the grade of inserts, ie.: A23-0802-M4-ME,B350

B23 Inserts

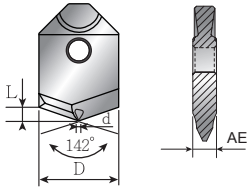

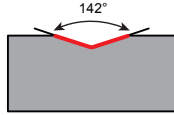

Tolerances (mm)

AE : + 0.01
- 0.02

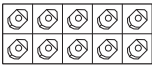

Dimensions (mm)				
D	d	L	AE	angle
8	0.7	1.28	2.0	142°
10	0.8	1.55	2.5	
12	0.9	1.86	3.0	
16	1.0	2.56		

Inserts	Order Code	Grades											
		Carbide					Cermet			Uncoated			
		C125	B350	C350	F20	F30	CE25	CE100	CE60	K10	CE		
	B23-0802-142-ME		☉										 Inserts 10 PCS / Box
	B23-1002-142-ME		☉										
	B23-1203-142-ME		☉										
	B23-1603-142-ME		☉										

- Steel
 ■ Stainless Steel
 ☉ Steel/Stainless Steel /Super alloy
 ■ Cast Iron
 ■ Aluminum
 ■ Steel/Cast Iron
 ☉ Steel/Stainless Steel/Cast Iron
- Prices and stocks are based on present conditions
- Please specify model numbers and the grade of inserts, ie.: B23-0802-142-ME,B350

Spot Drill



Recommended Cutting Data And Insert Grades

- Recommended spot cutting speed in Vc (m/min), fn (mm/rev).
- For spotting  the effective no. of teeth is calculated with 1 flute.

Material group	 Cutting Speed Vc(m/min)	fn (mm/rev)		Grades	
		D: 8~10mm	D: 12~16mm	ME	E
1-2	50-70	0.10 0.13	0.11 0.14	B350/C350	-
3	50-70	0.10 0.13	0.11 0.14	B350/C350	-
4-5-6	45-60	0.08 0.10	0.10 0.12	B350/C350	-
7	25-30	0.06 0.08	0.06 0.08	B350	-
8-9	35-45	0.08 0.10	0.10 0.12	B350	-
10-11	35-40	0.07 0.09	0.09 0.12	B350	-
12-13	70-90	0.12 0.15	0.13 0.16	C350	-
14-15	60-80	0.10 0.14	0.10 0.15	C350	-
16-18	200-300	0.12 0.15	0.13 0.16	-	F20

How to Fit Inserts - Screw A.B.C.

Screwing the Insert

Step 1: • Put the insert into the slot of shank and press it with the finger
 • Fully tighten the screw A first

Step 2: Half tighten the screw B on one side

Step 3: Half tighten the screw C on another side

Step 4: Fully tighten the screw B again (Important)

Step 5: Fully tighten the screw C again (Important)

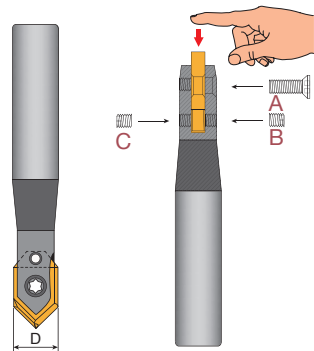

Standard spare parts

Insert dimension D (mm)	Screw A	Screw B/C	Key	Key
				
8	C02506	S025025	T08P	L013
10	C03008	S02503	T09P	L013
12	C03010	S0304	T09P	L015
16	C03512	S0405	T10P	L02

Recommended Cutting Data

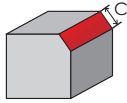
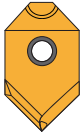

Side Chamfering

- For side chamfering the effective no. of teeth are 2 flutes.

Chamfering Application													
Materials		Steel		Heat Treatment		Stainless Steel		Inconel		Cast Iron		Aluminium	
Using Inserts		C350		C350		B350		B350		C350		F20	
Inserts	C	S (rev/min)	F (mm/min)	S (rev/min)	F (mm/min)	S (rev/min)	F (mm/min)	S (rev/min)	F (mm/min)	S (rev/min)	F (mm/min)	S (rev/min)	F (mm/min)
ø8	1mm	4800	720	2000	240	2400	280	1600	190	3200	640	8000	2000
ø10	1mm	3800	570	1600	190	1900	220	1300	160	2550	510	6300	1500
	2mm	3800	450	1600	160	1900	190	1300	130	2550	400	6300	1260
ø12	1mm	3200	480	1300	150	1600	190	1050	125	2100	420	5300	1250
	2mm	3200	380	1300	130	1600	160	1050	105	2100	340	5300	1050
	3mm	3200	320	1300	100	1600	130	1050	85	2100	250	5300	850
ø16	1mm	2400	360	1000	120	1200	145	800	95	1600	320	4000	960
	2mm	2400	290	1000	100	1200	120	800	80	1600	255	4000	800
	3mm	2400	240	1000	80	1200	100	800	65	1600	190	4000	480
	4mm	2000	160	800	65	1000	80	600	50	1400	140	3500	420

Spot Drill



Recommended Cutting Data

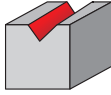
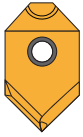

Grooving

V Groove Application													
Materials		Steel		Heat Treatment		Stainless Steel		Inconel		Cast Iron		Aluminium	
Using Inserts		C350		C350		B350		B350		C350		F20	
Inserts	Cut Depth	S (rev/min)	F (mm/min)	S (rev/min)	F (mm/min)	S (rev/min)	F (mm/min)	S (rev/min)	F (mm/min)	S (rev/min)	F (mm/min)	S (rev/min)	F (mm/min)
∅8	2mm	4800	380	1200	95	2400	140	1400	85	4000	640	8000	2400
∅10	2mm	3800	300	950	75	1900	115	1100	65	3200	500	6400	1920
	3mm	3800	230	950	55	1900	750	1100	45	3200	380	6400	1500
∅12	2mm	3200	260	800	65	1600	95	900	55	2650	420	5300	1600
	3mm	3200	190	800	50	1600	65	900	35	2650	320	5300	1300
∅16	2mm	2400	190	600	50	1200	70	700	40	2000	320	4000	1200
	3mm	2400	145	600	35	1200	50	700	30	2000	240	4000	960
	4mm	2400	100	600	25	1200	25	700	20	2000	200	4000	800

Recommended Cutting Data

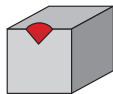

Spotting and Chamfering
in one step

Spot Application													
Materials		Steel		Heat Treatment		Stainless Steel		Inconel		Cast Iron		Aluminium	
Using Insert		C350		C350		B350		B350		C350		F20	
Inserts	Cut Depth	S (rev/min)	F (mm/min)	S (rev/min)	F (mm/min)	S (rev/min)	F (mm/min)	S (rev/min)	F (mm/min)	S (rev/min)	F (mm/min)	S (rev/min)	F (mm/min)
ø8	1mm	2000	300	800	95	1600	160	1000	100	2800	560	6000	1200
	2mm	2000	250	800	80	1600	120	1000	75	2800	490	6000	1050
	3mm	2000	250	800	80	1600	120	1000	75	2800	490	6000	1050
	4mm	2000	200	800	65	1600	80	1000	50	2800	420	6000	900
ø10	1mm	1600	240	650	80	1300	130	800	80	2200	440	4800	960
	2mm	1600	200	650	65	1300	100	800	60	2200	385	4800	840
	3mm	1600	200	650	65	1300	100	800	60	2200	385	4800	840
	4mm	1600	160	650	50	1300	65	800	40	2200	330	4800	720
	5mm	1300	130	500	40	1000	50	650	30	1900	285	4200	630
ø12	1mm	1300	200	550	65	1050	105	650	65	1850	370	4000	800
	2mm	1300	160	550	55	1050	80	650	50	1850	315	4000	700
	3mm	1300	160	550	55	1050	80	650	50	1850	315	4000	700

Spot Drill



Recommended Cutting Data

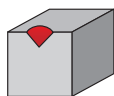

Spotting and Chamfering
in one step

Spot Application													
Materials		Steel		Heat Treatment		Stainless Steel		Inconel		Cast Iron		Aluminium	
Using Inserts		C350		C350		B350		B350		C350		F20	
Inserts	Cut Depth	S (rev/min)	F (mm/min)	S (rev/min)	F (mm/min)	S (rev/min)	F (mm/min)	S (rev/min)	F (mm/min)	S (rev/min)	F (mm/min)	S (rev/min)	F (mm/min)
ø12	4mm	1300	130	550	45	1050	50	650	35	1850	280	4000	600
	5mm	1050	105	400	45	800	40	530	30	1600	240	3500	525
	6mm	1050	85	400	30	800	30	530	20	1600	200	3500	430
ø16	1mm	1000	150	400	45	800	80	500	50	1400	280	3000	600
	2mm	1000	125	400	40	800	60	500	40	1400	245	3000	525
	3mm	1000	125	400	40	800	60	500	40	1400	245	3000	525
	4mm	1000	100	400	30	800	40	500	25	1400	210	3000	450
	5mm	800	80	300	25	600	30	400	20	1200	180	2600	390
	6mm	800	65	300	20	600	25	400	16	1200	150	2600	325
	7mm	800	65	300	20	600	25	400	16	1200	150	2600	325
	8mm	800	50	300	15	600	18	400	12	1200	120	2600	260

CENTER DRILL - 390 SYSTEM

Surface Finish Ra < 0.5 μ m

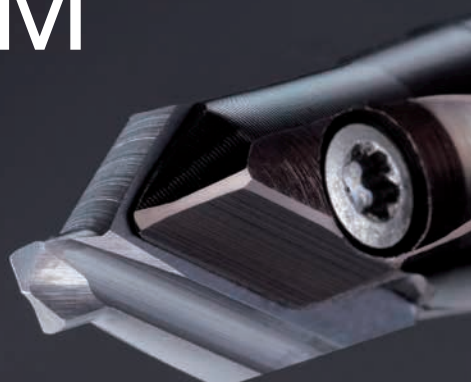
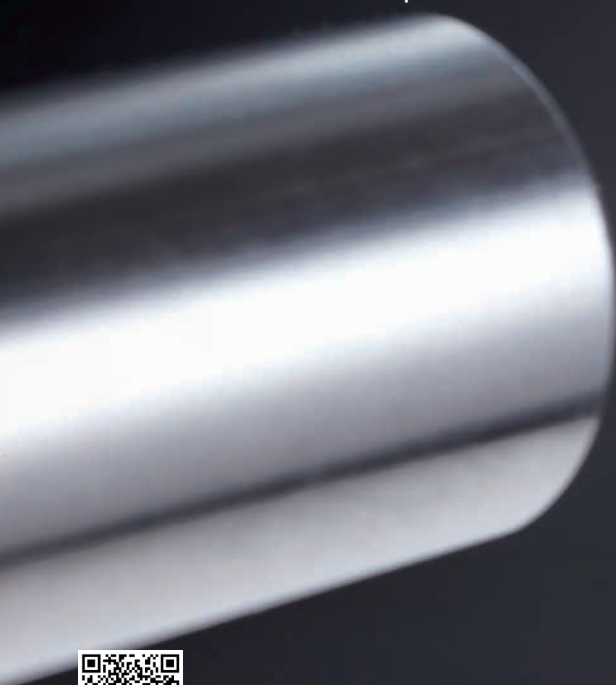

PATENTED



Video

Features

Available in
materials



Cost
300~500%
SAVING

Applicable
Machines
Milling / Turning

Efficiency
300%
UP

Durability
300%
UP



YIH TROUN ENTERPRISE CO., LTD

265

Product Design

One Shank fits 9 different inserts

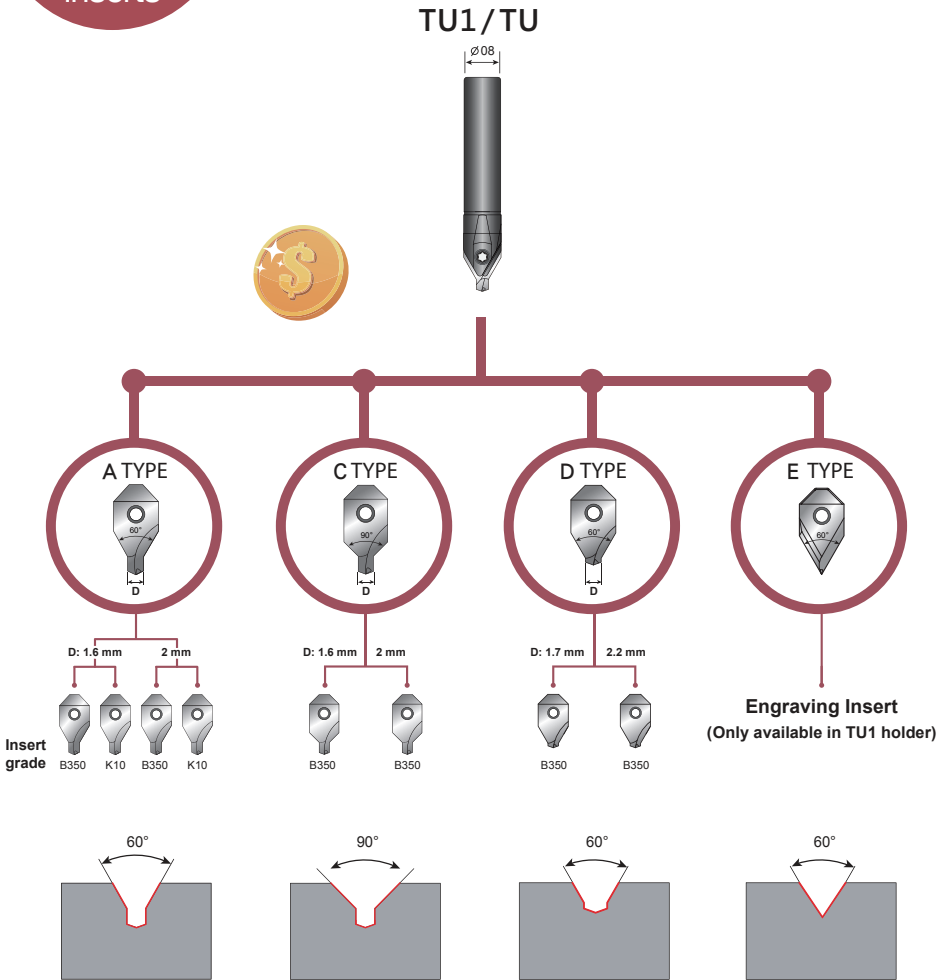

TECHNICAL GUIDE

Indexable center drill

- Extremely accuracy in center positioning, minimized eccentricity $\pm 0.008\text{mm}$.
- Perfect surface finish with $Ra\ 0.36\ \mu\text{m}$, which leads to excellent accuracy.
- Re-centering and length calibrating are not required while changing the new insert.
- Y.T. indexable carbide inserts perform 5 times tool life longer than HSS center drills.
- The same shank fit max. 9 different inserts.

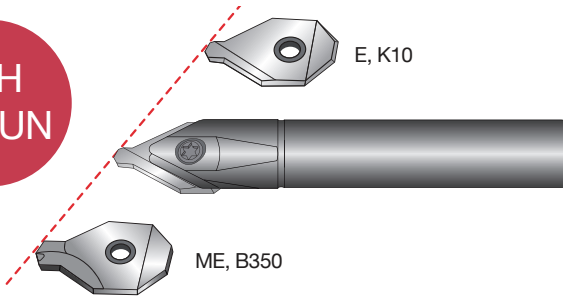

Center Drill

Solid center drill

- Imprecise center accuracy
- Poor tool life
- Require re-calibrating every time
- Poor surface finish

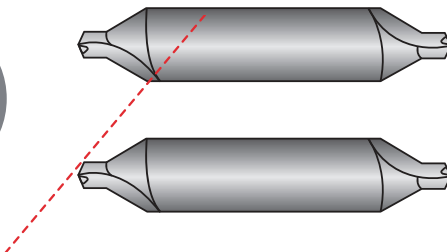





New Design vs. Traditional Type

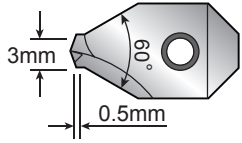

D-type Center Drill:

Designed with a shorter drill bit, suitable for center spotting with 60° chamfer simultaneously prior to hole drilling. It performs a greater machining durability itself and conduce to improve the tool life of drills and taps from its high accuracy.



- 
Efficiency
 400~600% up
- 
Durability
 400~600% up
- 
No broken

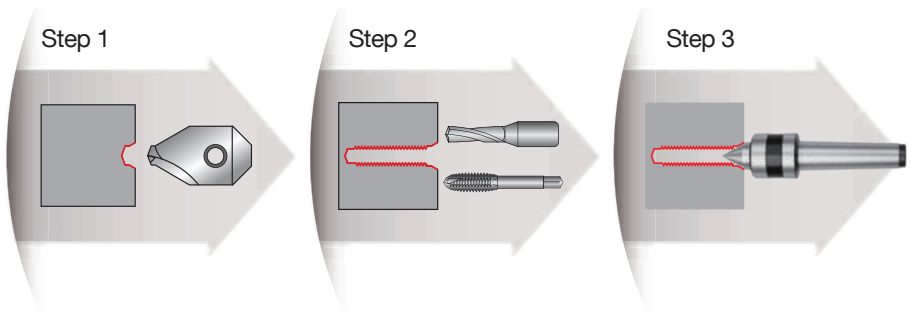

Traditional

Standard center drill: The long pilot length causes pilot broken often and poor tool life in high feed machining.

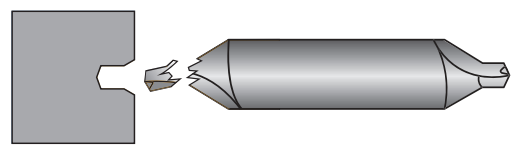
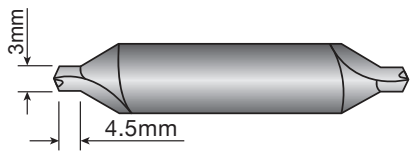

CENTRALIZER-Quick Operation Guide

Apply the centralizer while replacing inserts at the machine

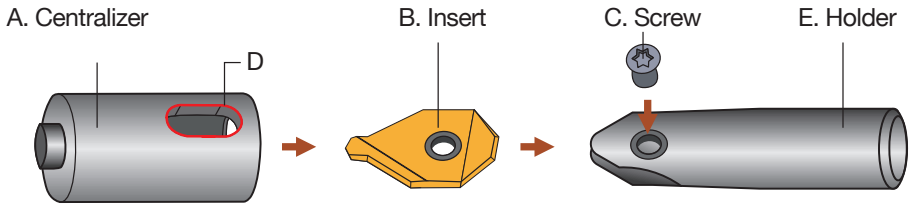

Mounting Steps

- Step 1.** Dismount the worn inserts and put a new one instead into the cavity.
- Step 2.** Put on the centralizer.
- Step 3.** Turn the shank holder, align the screw hole with the opening.
- Step 4.** Slide up the centralizer to push the insert against on the bottom.
- Step 5.** Tighten up the screw.
- Step 6.** Remove the centralizer, carry tool changing and calibrating off in a minute.

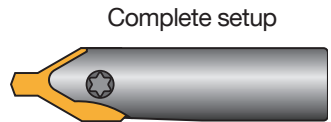
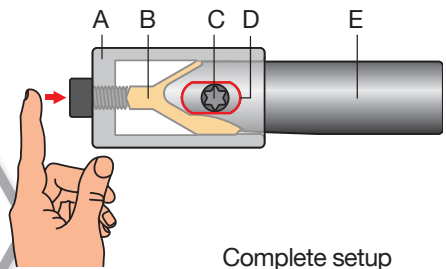

Center Drill

Devices to centralizer the inserts



Video

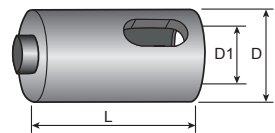

Order Code	D	D1	L
GA-0814	14	8.2	25
GA-1016	16	10.2	30
GA-1218	18	12.2	33
GA-1622	22	16.2	38



Center Drill Toolholders (Milling And Turning)

- Inserts P. 271 - 273
- Cutting Data P. 275
- Centralizer P. 269

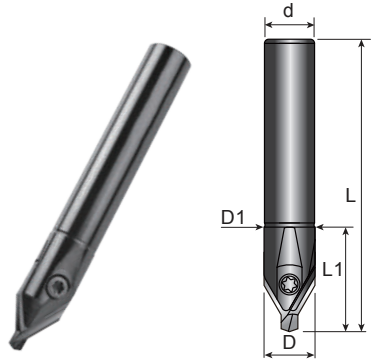

TU 1

Order Code	Dimensions (mm)					KG	Inserts A/C/D/ E24	Screw	Key
	D	D1	d	L	L1				
TU1-0808-60	8.2	8.2	8	60	20	0.08	0802	C02506	T08P
TU1-0808-80				80		0.09			
TU1-1010-65	10.2	10.2	10	65	25	0.09	1002	C03009	T09P
TU1-1212-65	12.2	12.2	12	65	30	0.11	1203	C03010	
TU1-1616-70	16.2	16.2	16	70	35	0.17	1603	C03512	T10P

Center Drill Toolholders (Turning)

- Inserts P. 271 - 273
- Cutting Data P. 275
- Centralizer P. 269

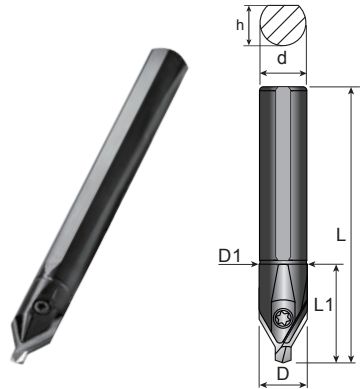

TU

Order Code	Dimensions (mm)						KG	Inserts A/C/ D24	Screw	Key
	D	D1	d	L	L1	h				
TU-0808-85	8.2	8.2	8	85	20	7.5	0.08	0802	C02506	T08P
TU-1010-100	10.2	10.2	10	100	25	9.3	0.11	1002	C03009	T09P
TU-1212-110	12.2	12.2	12	110	30	11.5	0.15	1203	C03010	
TU-1616-130	16.2	16.2	16	130	35	15.5	0.26	1603	C03512	T10P

A24 Inserts

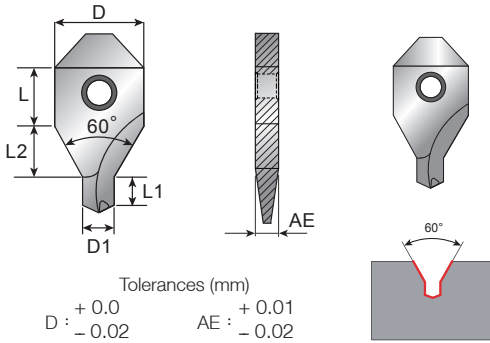

Dimensions (mm)						
D	L	AE	D1	L1	L2	Angle
8.2	6	2.0	1.6	1.6	5.0	60°
			2.0	2.0	5.0	
10.2	7	2.5	2.5	2.2	6.0	
			3.0	2.6	6.0	
			4.0	3.3	7.0	
12.2	7	3.0	5.0	4.0	6.0	
			5.0	4.0	9.0	
16.2	8	3.0	6.0	4.7	8.0	
			8.0	6.5	6.5	

Inserts	Order Code	Grades												
		Carbide					Cermet			Uncoated				
		C125	B350	C350	F20	F30	CE25	CE100	CE60	K10	CE			
	A24-080216-60-E													 Inserts 6 PCS / Box Only for insert: A24-16***
	A24-080220-60-E													
	A24-100225-60-E													
	A24-100230-60-E													
	A24-120340-60-E													
	A24-120350-60-E													
	A24-160350-60-E													
	A24-160360-60-E													
	A24-080216-60-ME		⊗											 Inserts 10 PCS / Box
	A24-080220-60-ME		⊗											
	A24-100225-60-ME		⊗											
	A24-100230-60-ME		⊗											
	A24-120340-60-ME		⊗											
	A24-120350-60-ME		⊗											
	A24-160350-60-ME		⊗											
	A24-160360-60-ME		⊗											
	A24-160380-60-ME		⊗											

- Steel Stainless Steel Steel/Stainless Steel /Super alloy Cast Iron Aluminum Steel/Cast Iron Steel/Stainless Steel/Cast Iron
- Prices and stocks are based on present conditions
- Please specify model numbers and the grade of inserts, ie.: A24-080216-60-E,K10



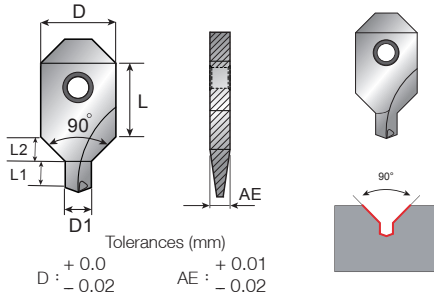

Center Drill

C24 Inserts

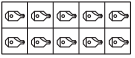

Dimensions (mm)						
D	L	AE	D1	L1	L2	Angle
8.2	8	2.0	1.6	1.6	3.0	90°
			2.0	2.0	3.0	
10.2	10	2.5	2.5	2.2	3.5	
			3.0	2.6	3.5	
12.2	10	3.0	4.0	3.3	4.0	
			5.0	4.0	3.5	
16.2	12	3.0	5.0	4.0	5.5	
			6.0	4.7	5.0	

Inserts	Order Code	Grades										
		Carbide					Cermet			Uncoated		
		C125	B350	C350	F20	F30	CE25	CE100	CE60	K10	CE	
	C24-080216-90-ME		⊗									 Inserts 6 PCS / Box Only for insert: C24-16***
	C24-080220-90-ME		⊗									
	C24-100225-90-ME		⊗									 Inserts 10 PCS / Box
	C24-100230-90-ME		⊗									
	C24-120340-90-ME		⊗									
	C24-120350-90-ME		⊗									
	C24-160350-90-ME		⊗									
C24-160360-90-ME		⊗										

- Steel
 ■ Stainless Steel
 ⊗ Steel/Stainless Steel /Super alloy
 ■ Cast Iron
 ■ Aluminum
 ■ Steel/Cast Iron
 ⊗ Steel/Stainless Steel/Cast Iron
- Prices and stocks are based on present conditions
- Please specify model numbers and the grade of inserts, ie.: C24-080216-90-ME,B350

D24 Inserts



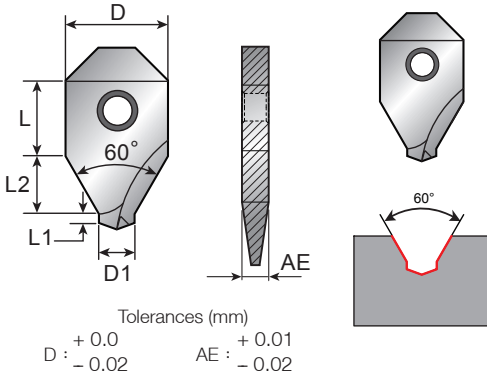

Center drill specially for pre-drilling and pre-tapping



Dimensions (mm)						
D	L	AE	D1	L1	L2	Angle
8.2	6	2.0	1.7	0.6	5.5	60°
			2.2	0.6	5.0	
10.2	7	2.5	2.7	0.6	6.0	
			3.2	0.7	6.0	
			3.7	0.7	5.5	
12.2	7	3.0	4.3	0.8	6.5	
			5.3	1.0	5.5	
			5.3	1.0	9.0	
16.2	8	3.0	5.3	1.0	9.0	
			6.3	1.1	8.0	

Center Drill

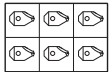
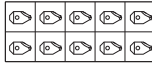
Inserts	Order Code	Grades										
		Carbide					Cermet			Uncoated		
		C125	B350	C350	F20	F30	CE25	CE100	CE60	K10		CE
	D24-080217-60-ME		⊗									
	D24-080222-60-ME		⊗									
	D24-100227-60-ME		⊗									
	D24-100232-60-ME		⊗									Inserts 6 PCS / Box Only for insert: D24-16***
	D24-100237-60-ME		⊗									
	D24-120343-60-ME		⊗									
	D24-120353-60-ME		⊗									
	D24-160353-60-ME		⊗									
	D24-160363-60-ME		⊗									

- ■ Steel ■ Stainless Steel ⊗ Steel/Stainless Steel /Super alloy ■ Cast Iron ■ Aluminum ■ Steel/Cast Iron
- ⊗ Steel/Stainless Steel/Cast Iron
- Prices and stocks are based on present conditions
- Please specify model numbers and the grade of inserts, ie.: D24-080217-60-ME,B350



High Efficiency Metal Engraving Tool

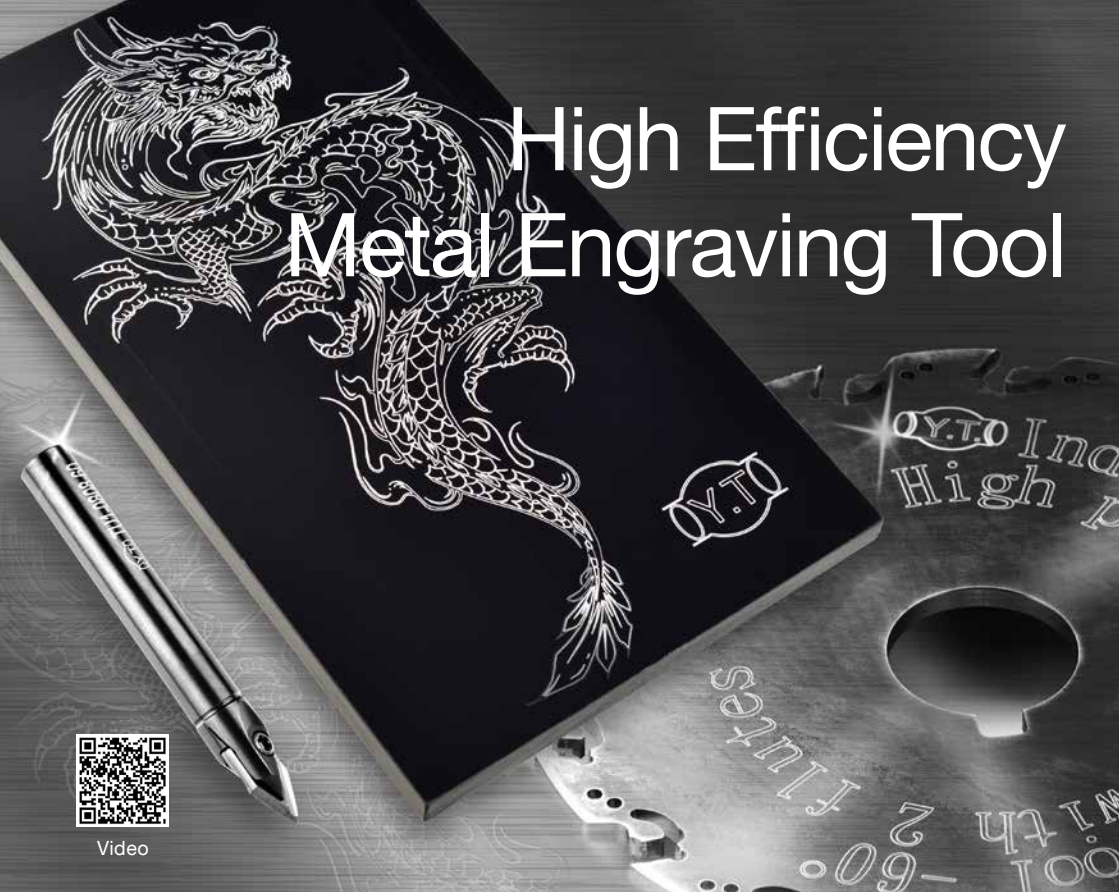

Video

E24 Inserts

- Toolholder P. 270
- Centralizer P. 269
(Centralizer is necessary)

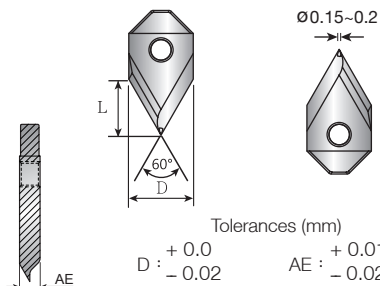

Dimensions (mm)			
D	L	AE	Angle
8.2	4	2.0	60°

Inserts	Order Code	Grades								Toolholder	Centralizer	
		Carbide					Cermet		Uncoated			
		C125	B100	C350	F20	F30	CE100	CE60	K10			CE
	E24-0802-60-E		★								TU1-0808	GA-0814

★ All Materials

• Recommend cutting data : Vc:100m/min (Aluminum Vc:500m/min)
Fn(0.01-0.03mm/rev).

Recommended Cutting Data And Insert Grade

- Center Drill recommended cutting speed, Vc(m/min), fn(mm/ tooth).
The effective no. of teeth is calculated with 1 flute.

Material group	 Cutting Speed Vc(m/min)	CNC lathe M/C Vc(m/min)	fn(mm/rev)		Grades	
			D1:1.5~2.5mm	D1:3~10mm	ME	E
1-2	15-20	50-120	0.03 0.06	0.05 0.10	B350	-
3	12-18		0.03 0.06	0.05 0.10	B350	-
4-5-6	10-15		0.03 0.06	0.05 0.10	B350	-
7	5-10	22-30	0.03 0.06	0.05 0.08	B350	-
8-9	8-12		0.03 0.06	0.05 0.09	B350	-
10-11	5-10		0.03 0.06	0.03 0.08	B350	-
12-13	20-25	60-80	0.05 0.08	0.06 0.13	B350	-
14-15	15-20		0.05 0.08	0.06 0.13	B350	-
16-18	30-50	300-800	0.05 0.08	0.06 0.13	-	K10

Center Drill

Surface Finishing Test Result

Holder	TU-1010-100	Mitutoyo SURFTEST SJ-410 日期 2017/07/05 時間 09:20:32
Insert	24-100225-60-ME, B100	Ra 0.360 μm Rmax 2.056 μm
S	1600 min ⁻¹	Mitutoyo SURFTEST SJ-410 日期 2017/07/05 時間 09:20:32
f	0.05 mm/rev	Ra 14.16 μin Rmax 80.94 μin
Material	ScM440	



TRY ME BOX



**1 shank + 2 inserts +
1 Centralizer gauge**

Available sizes in A24 inserts :
1.6/2.0/2.5/3.0/4.0/5.0/6.0mm

Order Code	Description	Type	Quantity
CD081620B350	TU1-0808-60	Shank: 8mm-60L	1
	A24-080216-60-ME,B350	Insert: 1,6mm for P M K S H	1
	A24-080220-60-ME,B350	Insert: 2,0mm for P M K S H	1
	GA-0814	Centralizer	1
CD102530B350	TU1-1010-65	Shank: 10mm-65L	1
	A24-100225-60-ME,B350	Insert: 2,5mm for P M K S H	1
	A24-100230-60-ME,B350	Insert: 3,0mm for P M K S H	1
	GA-1016	Centralizer	1
CD124050B350	TU1-1212-65	Shank: 12mm-65L	1
	A24-120340-60-ME,B350	Insert: 4,0mm for P M K S H	1
	A24-120350-60-ME,B350	Insert: 5,0mm for P M K S H	1
	GA-1218	Centralizer	1
CD165060B350	TU1-1616-70	Shank: 16mm-70L	1
	A24-160350-60-ME,B350	Insert: 5,0mm for P M K S H	1
	A24-160360-60-ME,B350	Insert: 6,0mm for P M K S H	1
	GA-1622	Centralizer	1



Convenient Durable Efficiency

1 shank + 2 inserts

Available sizes in inserts 23 and A23 :

08/10/12/16mm

90° / 90° + 142°



Order Code	Description	Type	Quantity
SD0823A23B350	13-0808-60	Shank: 8mm-60L	1
	23-0802-90-ME,B350	Insert: 90° for P M S H	1
	A23-0802-M4-ME,B350	Insert: 90° + 142° for P M S H	1
SD1023A23B350	13-1010-65	Shank: 10mm-65L	1
	23-1002-90-ME,B350	Insert: 90° for P M S H	1
	A23-1002-M5-ME,B350	Insert: 90° + 142° for P M S H	1
SD1223A23B350	13-1212-80	Shank: 12mm-80L	1
	23-1203-90-ME,B350	Insert: 90° for P M S H	1
	A23-1203-M6-ME,B350	Insert: 90° + 142° for P M S H	1
SD1623A23B350	13-1616-100	Shank: 16mm-100L	1
	23-1603-90-ME,B350	Insert: 90° for P M S H	1
	A23-1603-M8-ME,B350	Insert: 90° + 142° for P M S H	1



COUNTER BORE SERIES





Features Description

4 In 1 Counter Bore: M3-M12

Only 2 machining process is needed.

Only 2 seconds get the job making counterbore done !

Counter Bore: M8-M36

Counter Bore with chamfer: M8-M36

Patented design with carbide strip on the head to improve cutters tool life.

The most economical insert with 4 cutting edges.

PATENTED

4 IN 1 COUNTER BORE

PATENTED



Video

Patent No.
M473882
M474588
M473881



Patent No.
201310453057.2
201320772697.5



PCT Priority

Features

Available in
materials



Cost
300~500%
SAVING

Applicable
Machines

Milling / Drilling
/ Radial drilling

Efficiency
300%
UP

Durability
300%
UP

Traditional Procedure: 5 Steps

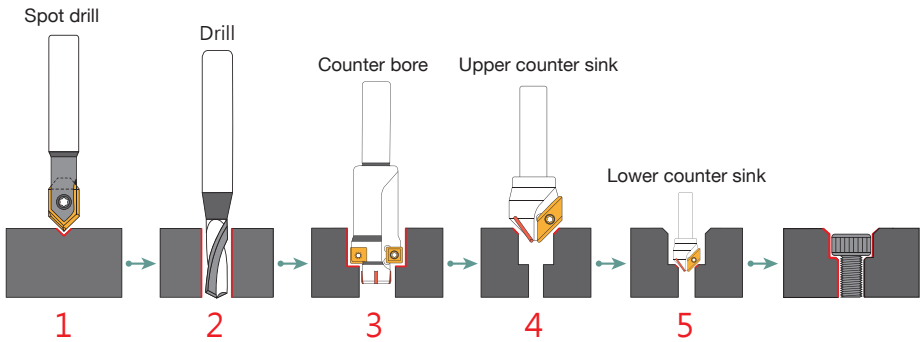

Innovative solution: 2 Steps

Get the job making counterbore within 2 seconds.

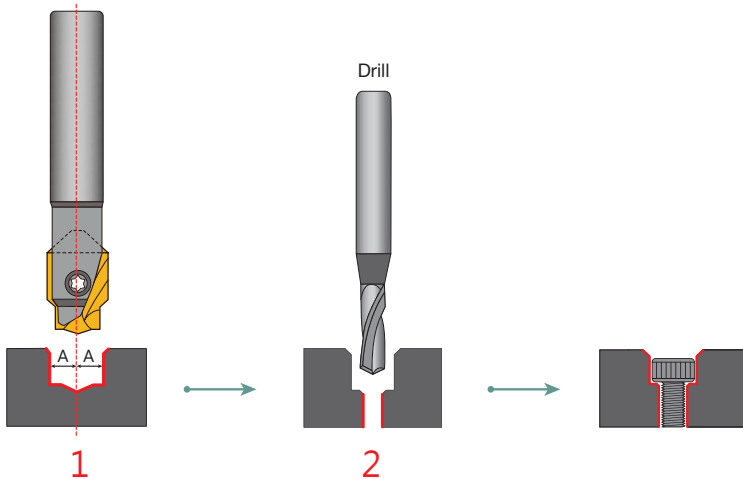

• Finish 4 operations in one.



Product Design

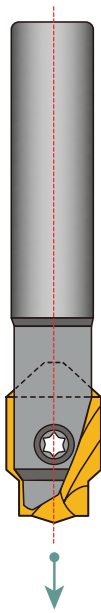

• The same shank fits max. 16 different inserts.

4 main functions

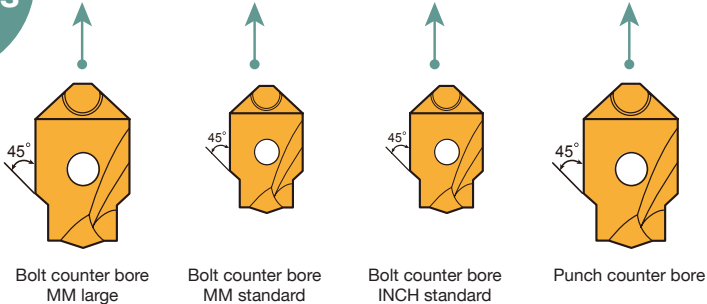

* Screws M3~M12

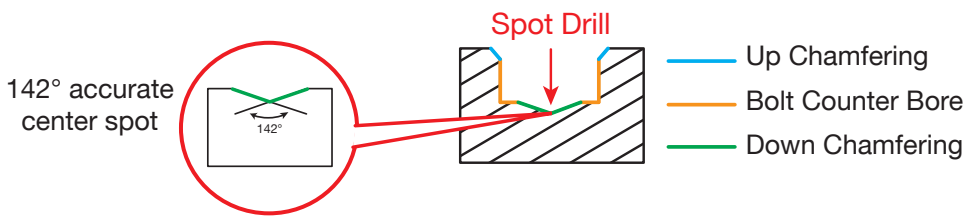

Recommendations and constraints :

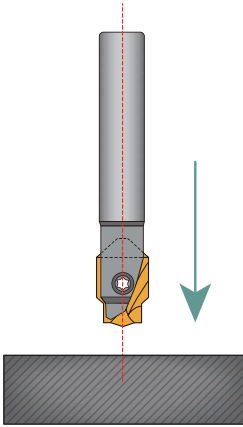

Suitable for vertical machining on flat surface.

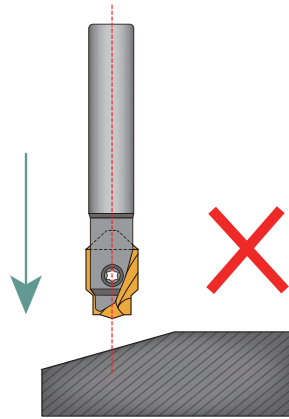

It's not recommended to use 4 in 1 tool on inclined surface.

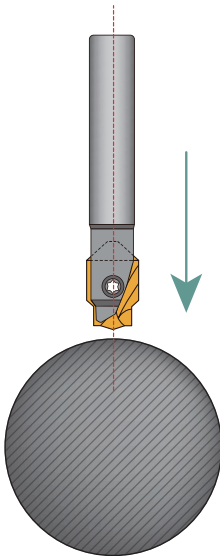

It can be used for round workpiece as long as it's center vertical alignment.

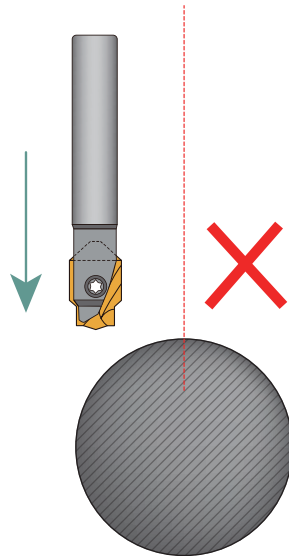

4 in 1 tool is not recommended to be used for curved surface or round workpiece when it's central misalignment.





Machining in M4 screw holes

Testing information:

Material: Steel S45C/ Vc: 70m/min/ Fz: 0.07 mm/ tooth

Toolholder: 14 -1004-80/ Insert: 26 -1004ST-M, B100

Toollife of one insert can machine 2100 holes

PRODUCT SPECIFICATIONS

4 in 1 Counter Bore Shank

- Inserts P. 286 - 288
- Cutting Data P. 290

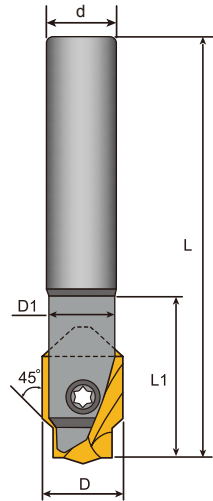

14

Counterbore

Order Code	Counterbore Screw size		Ejector Pin	Dimensions (mm)					KG	Screw	Key
	MM	INCH		D	D1	d	L	L1			
14-0803-70	3.0 3.5	1/8	-	8	7.4	8	70	20	0.08	C02506	T08P
14-0803-90		-					90				
14-1004-80	4.0	3/16	5.0	10	9.4	10	80	25	0.11	C03007	T09P
14-1004-100							100				
14-1206-80	5.0 6.0	-	6.0	12	11.3	12	80	25	0.12	C03008	T09P
14-1206-110		1/4					110				
14-1608-100	7.0 8.0	-	8.0 10.0	16	15.4	16	100	30	0.22	C03509	T10P
14-1608-130		5/16					130				
14-2010-100	10 12	3/8	13.0	20	19.0	20	100	35	0.30	C04011	T15P
14-2010-140							140				



4 in 1 Counter Bore Inserts

MM / INCH standard size dimensions- DIN373

 Inserts 6 PCS / Box
 Only for insert : 26-2010
 26-2012

 Inserts 10 PCS / Box

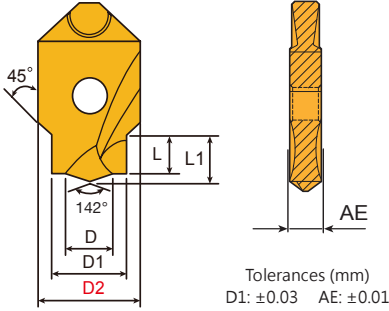

Dimensions (mm)						Counterbore Screw size	
D	D1	D2	L	L1	AE	MM	INCH
3.6	5.8	8	3.1	3.65	2.0	M3.0	1/8
4.1	6.3		3.6	4.25		M3.5	-
4.6	7.4	10	4.2	4.95	2.5	M4.0	-
5.6	9.3		5.3	6.25		M5.0	3/16
6.7	10.4	12	6.4	7.50	3.0	M6.0	1/4
7.7	11.5		7.4	8.70		M7.0	-
8.7	13.5	16	8.4	9.85	3.5	M8.0	5/16
10.8	16.5		10.3	12.15		M10	3/8
13.3	19.0	20	12.3	14.60	3.5	M12	-

* For other sizes, customization is acceptable.

Inserts	Order Code	Grades										Corresponding shank	
		Carbide					Cermet			Uncoated			
		B100	C125	C350	F20	F30	CE25	CE100	CE60	K10	CE		
	26-0803-E												14-0803-70 14-0803-90
	26-0803-ME	⊙											
	26-0803T-M	⊙											
	26-08035-E												
	26-08035-ME	⊙											
	26-08035T-M	⊙											
	26-1004-E												14-1004-80 14-1004-100
	26-1004-ME	⊙											
	26-1004T-M	⊙											
	26-1205-E												14-1206-80 14-1206-110
	26-1205-ME	⊙											
	26-1205T-M	⊙											
	26-1206-E												
	26-1206-ME	⊙											
	26-1206T-M	⊙											
	26-1607-E												14-1608-100 14-1608-130
	26-1607-ME	⊙											
	26-1607T-M	⊙											
	26-1608-E												
	26-1608-ME	⊙											
	26-1608T-M	⊙											
	26-2010-E												14-2010-100 14-2010-140
	26-2010-ME	⊙											
	26-2010T-M	⊙											
	26-2012-E												
	26-2012-ME	⊙											
	26-2012T-M	⊙											



- ⊙ Cast Iron/ Stainless Steel / Super alloy □ Aluminum ■ Steel/ Cast Iron/ Hardness steel
- Prices and stocks are based on present conditions
- Please specify model numbers and the grade of inserts, ie.: 26-0803-E, F20

4 in 1 Counter Bore Inserts (Big)

MM large size dimensions- DIN373

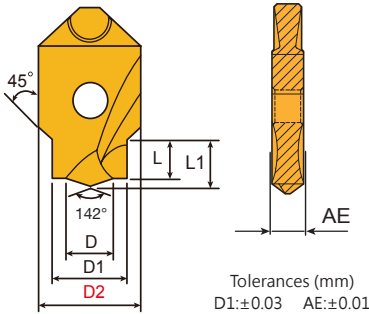

 Inserts 6 PCS / Box
Only for insert : 26-2010S

 Inserts 10 PCS / Box

Dimensions (mm)						Counterbore Screw size
D	D1	D2	L	L1	AE	MM
3.8	6.5	8	3.1	3.70	2.0	M3.0
4.8	8.0	10	4.2	5.00	2.5	M4.0
5.8	10	12	5.3	6.25	3.0	M5.0
6.9	11		6.4	7.50		M6.0
9.3	15	16	8.4	9.95		M8.0
11.3	18	20	10.3	12.20	3.5	M10

* For other sizes, customization is acceptable.

Inserts	Order Code	Grades										Corresponding shank		
		Carbide					Cement			Uncoated				
		B100	C125	C350	F20	F30	CE25	CE100	CE60	K10	CE			
	26-0803S-E													14-0803-70 14-0803-90
	26-0803S-ME	⊙												
	26-0803ST-M	⊙	■											
	26-1004S-E													14-1004-80 14-1004-100
	26-1004S-ME	⊙												
	26-1004ST-M	⊙	■											
	26-1205S-E													14-1206-80 14-1206-110
	26-1205S-ME	⊙												
	26-1205ST-M	⊙	■											
	26-1206S-E													
	26-1206S-ME	⊙												
	26-1206ST-M	⊙	■											
	26-1608S-E													14-1608-100 14-1608-130
	26-1608S-ME	⊙												
	26-1608ST-M	⊙	■											
26-2010S-E													14-2010-100 14-2010-140	
26-2010S-ME	⊙													
26-2010ST-M	⊙	■												

- ⊙ Cast Iron/ Stainless Steel / Super alloy ■ Aluminum ■ Steel/ Cast Iron/ Hardness steel
- Prices and stocks are based on present conditions
- Please specify model numbers the and grade of inserts, ie.: 26-0803S-E, F20



Counterbore

4 in 1 Ejector Pin Counter Bore Inserts

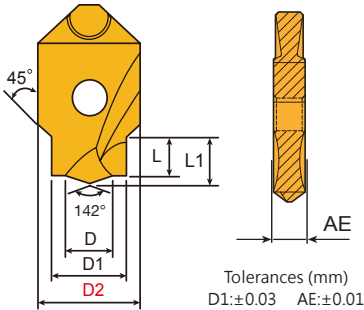

 Inserts 6 PCS / Box
 Only for insert : 27-2013T

 Inserts 10 PCS / Box

Dimensions (mm)						Ejector Pin Screw Size
D	D1	D2	L	L1	AE	MM
5.5	9	10	5	5.85	2.5	5.0
6.5	10	12		6.05	3.0	6.0
8.5	12	16		6.40		8.0
10.5	14			6.75		10
13.5	17	20		7.25	3.5	13

* For other sizes, customization is acceptable.

Inserts	Order Code	Grades										Corresponding shank
		Carbide					Cermet			Uncoated		
		B100	C125	C350	F20	F30	CE25	CE100	CE60	K10	CE	
	27-1005T-M											14-1004-80 14-1004-100
	27-1206T-M											14-1206-80 14-1206-110
	27-1608T-M											14-1608-100
	27-1610T-M											14-1608-130
	27-2013T-M											14-2010-100 14-2010-140

-  Steel/ Cast Iron/ Hardness steel
- Prices and stocks are based on present conditions
- Please specify model numbers the and grade of inserts, ie.: 27-1005T-M, B100

How to Fit Insert - Screw A

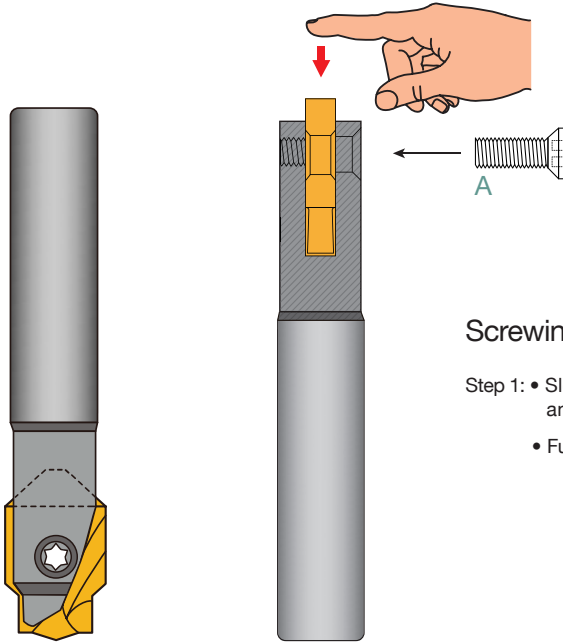

Screwing the Inserts

- Step 1:
- Slot the insert into the shank and push it against the bottom
 - Fully tighten the screw A

Standard spare parts

Insert Dimension D2 (mm)	Screw A	Key
		
8	C02506	T08P
10	C03007	T09P
12	C03008	
16	C03509	T10P
20	C04011	T15P



Recommended Cutting Data And Insert Grade

The effective no. of teeth is calculated with 1 flute.

Material group	 Cutting Speed Vc (m/min)	fn (mm/rev)				Grades		
		142°				E	ME	M
		(D2) 8	(D2) 10	(D2) 12	(D2) 16-20			
1-2	50-70	0.06 0.08	0.06 0.08	0.07 0.09	0.07 0.09	-	-	B100
3	50-70	0.06 0.08	0.06 0.08	0.07 0.09	0.07 0.09	-	-	B100
4-5-6	45-60	0.05 0.07	0.05 0.07	0.06 0.08	0.06 0.08	-	-	B100
7	25-30	0.04 0.06	0.04 0.06	0.05 0.07	0.05 0.07	-	-	B100
8-9	35-45	0.06 0.08	0.06 0.08	0.07 0.09	0.07 0.09	-	B100	-
10-11	35-40	0.05 0.07	0.05 0.07	0.06 0.08	0.06 0.08	-	B100	-
12-13	70-90	0.12 0.15	0.12 0.15	0.13 0.16	0.13 0.16	-	B100	-
14-15	60-80	0.11 0.14	0.11 0.14	0.12 0.15	0.12 0.15	-	B100	-
16-18	100	0.14 0.19	0.14 0.19	0.15 0.20	0.15 0.20	F20	-	-

- While applying it as a spot drill the RPM and FEED can be increased 50%.

Bolt counter bore dimensions (DIN 373 - ISO 4205)

Unit: mm

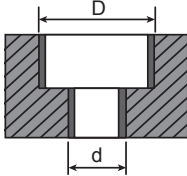
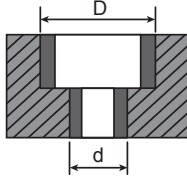
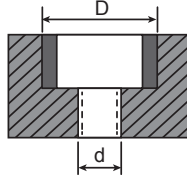
Screw Dimensions	Standard (D x d)	Large (D x d)	Screw (D x d)
Dimension			
M1.0	2.1 x 1.1	2.2 x 1.2	2.2 x 0.75
M1.2	2.4 x 1.3	2.5 x 1.4	2.5 x 0.95
M1.4	2.7 x 1.5	2.8 x 1.6	2.8 x 1.1
M1.5-M1.6	3.2 x 1.7	3.3 x 1.8	3.3 x 1.25
M1.7	3.7 x 1.8	3.8 x 1.9	3.8 x 1.3
M2.0	4.2 x 2.2	4.3 x 2.4	4.3 x 1.6
M2.2	4.6 x 2.4	4.8 x 2.6	4.8 x 2.6
M2.3	5.0 x 2.7	5.2 x 2.9	5.0 x 1.9
M2.5-M2.6	5.4 x 2.8	5.5 x 3.0	5.5 x 2.1
M3.0	5.8 x 3.2	6.0 x 3.4	6.0 x 2.5
M3.5	6.3 x 3.7	6.5 x 3.9	6.5 x 2.9
M4.0	7.4 x 4.3	8.0 x 4.5	8.0 x 3.3
M5.0	9.3 x 5.3	10.0 x 5.5	10.0 x 4.2
M6.0	10.4 x 6.4	11.0 x 6.6	11.0 x 5.0
M8.0	13.5 x 8.4	15.0 x 9.0	15.0 x 6.8
M10	16.5 x 10.5	18.0 x 11	18.0 x 8.5
M12	19.0 x 13	20.0 x 14	20.0 x 10.2
M14	24.0 x 15	24.0 x 16	-
M16	26.0 x 17	26.0 x 18	-

Counterbore



INDEXABLE COUNTER BORE

PATENTED



Video

Features

Available in materials



Cost
300~500%
SAVING

Applicable
type is
available
max. 300mm

Applicable
Machines
Milling / Drilling
/ Radial drilling

Efficiency
300%
UP

Durability
300%
UP

Product Design



Counter bore tools application for bolts, nuts & screws

 Patent No. ZL 01 2 23413.3

 PCT Priority

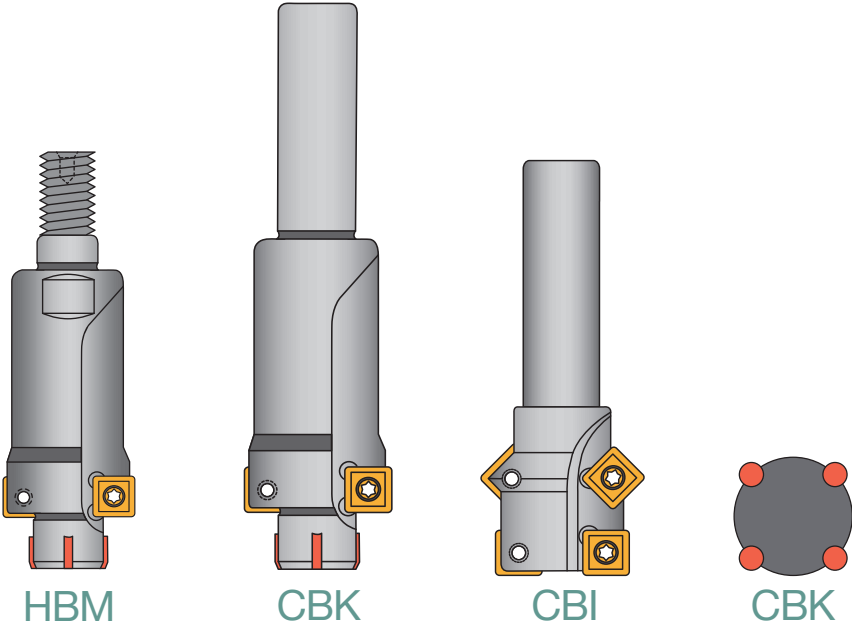

Counterbore

Screw ranges M8~M36

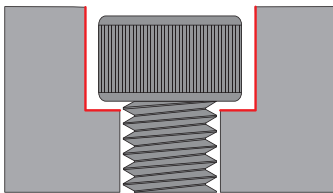

counterbore

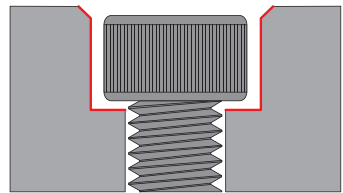

counterbore + chamfer



PRODUCT SPECIFICATIONS

Counterbore Toolholders

- Inserts P. 297
- Cutting Data P. 297

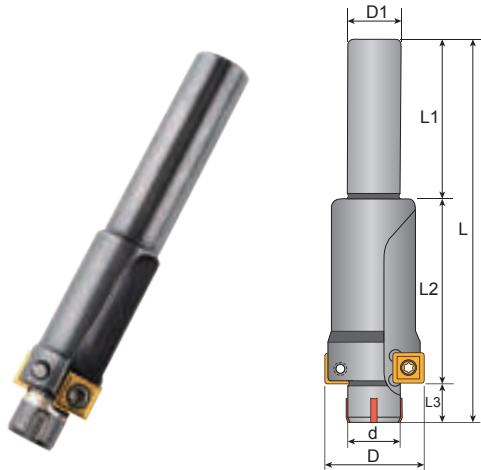

CBK

DIN 373

Order code	Dimensions (mm)							Z	 KG	MAX RPM	Inserts SDET	Screw	Key
	D	d	D1	L	L1	L2	L3						
CBK-08	14	8.4	10	70	30	32	8	2	0.09	25000	060208	C025045	T08P
CBK-08S	15	8.9											
CBK-10	18	10.9											
CBK-10S	20	13.4											
CBK-12	22	14.9	12	80	35	37			0.16	22000	09T308	C04007	T15P
CBK-12S	24	15.4											
CBK-14S	25	17.4											
CBK-16	26	17.4											
CBK-16S	27	17.4	90	38	44	0.24	17000	C04008					

* Use on drilling machine.

Counterbore Combi Cutters

- Inserts P. 297
- Cutting Data P. 297

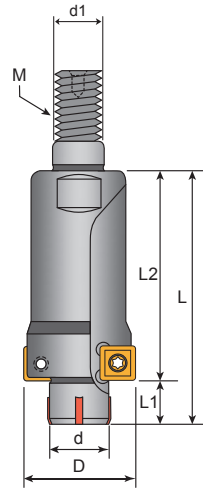

Counterbore

HBM

DIN 373

Order code	Dimensions (mm)							Z	KG	MAX RPM	Inserts SDET	Screw	Key
	D	d	L	L1	L2	M	d1						
HBM-16	26	17.4	48	8	40	16	22	2	0.23	17000	09T308	C04008	T15P
HBM-18	29	19.4	53		45								
HBM-20	33	21.9	56		48								
HBM-22	36	23.4	60	10	50	16	22	3	0.40	15000	09T308	C04008	T15P
HBM-24	40	25.9	62		52								
HBM-30	50	32.9	62		52								
HBM-36	58	38.8	62	52	52	16	22	3	0.65	10000	09T308	C04008	T15P

* Use on drilling machine.



Counterbore + Chamfer Toolholders

- Inserts P. 297
- Cutting Data P. 297

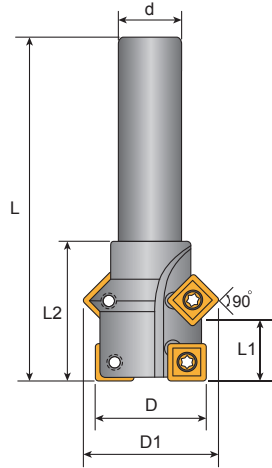

CBI

DIN 373

Order Code	Dimensions (mm)						Z	Zc	MAX RPM	Inserts SDET	Screw	Key	
	D	d	D1	L	L1	L2							
CBI-08	15	10	20.0	65	9	23	4	2	0.09	060208	C025045	T08P	
CBI-10	18		22.0		11				0.09				
CBI-12	20	23.8	13	0.12									
CBI-14	24	12	31.4	70	15	30			0.17	22000	09T308	C04007	T15P
CBI-16	26		33.4		16.5				0.20				
CBI-18	29	16	35.4	80	19.5	36			0.25	16000	09T308	C04008	T15P
CBI-20	33		37.4		21				0.27				
CBI-22	36	20	40.4	90	23.5	40			0.41	15000	09T308	C04011	T15P
CBI-24	40		44.4		25				0.45				
CBI-30	50	25	53.4	100	34	50			0.71	14000	09T308	C04011	T15P
CBI-36	58		61.4		38		0.94						

* Use on CNC machine.

SDET Inserts

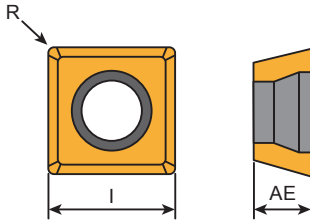

Tolerances (mm)
 I AE
 ±0,03 ±0,025

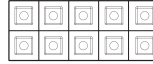

Inserts 10 PCS / Box

Code	Dimensions (mm)		
	I	AE	R
060208	6.0	2.3	0.3
09T308	9.0	3.97	0.5

Inserts	Order Code	Grades								
		Carbide					Metal cermet		Uncoated	
		B100	C200	C250	F20	F30	CE25	CE60	K10	CE
	SDET060208N-ME	☉								
	SDET09T308TN-M	☉								
	SDET09T308TN-ME	☉								

- Steel ■ Stainless Steel ☉ Steel/Stainless Steel /Super alloy ■ Cast Iron ■ Aluminum ■ Steel/Cast Iron
 ☉ Steel/Stainless Steel/Cast Iron
- Prices and stocks are based on present conditions
- Please specify model numbers and the grade of inserts, i.e.: SDET060208N-ME,B100

Recommended Cutting Data and Grade

- Recommended Cutting Speed, Vc(m/min), fz(mm/ tooth)

Material group	Cutting Speed Vc (m/min)	fz (mm/tooth)		Insert Grade Selection	
		M8 - M12	M14 - M36	M	ME
1-2	40-70	0.06 0.10	0.10 0.15	B100	B100
3	35-60	0.06 0.10	0.08 0.12	B100	B100
4-5-6	30-55	0.06 0.10	0.08 0.10	B100	B100
7	20-30	0.06 0.08	0.06 0.08	B100	B100
12-13	40-70	0.08 0.12	0.10 0.15	F30	F30
14-15	35-65	0.08 0.10	0.10 0.15	F30	F30



CHAMFER KING SERIES



Video

Features Description

The indexable countersink with carbide insert can be used in all kinds of machines, include drilling machine, electric hand tool...etc. The patented unique design "carbide strip" enhance the cutter toollife. Available from $\varnothing 4$ - $\varnothing 110$ mm.



INDEXABLE CHAMFER KING

PATENTED

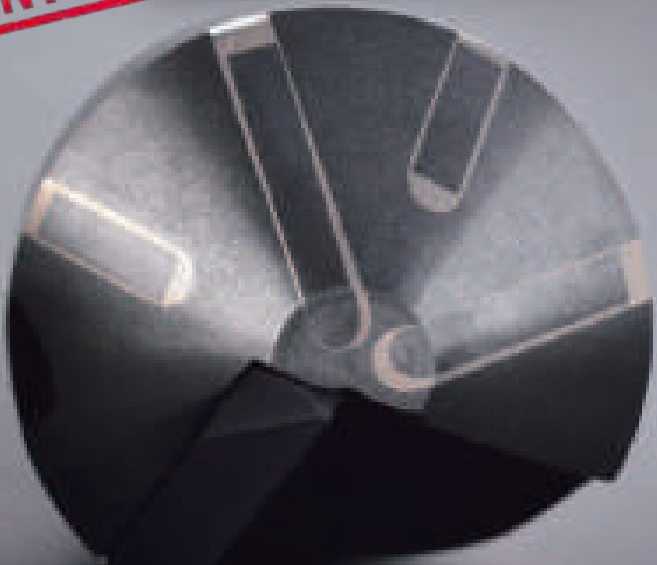

Video

Features

Available in materials

P K M
N S H

Cost
300~500%
SAVING

Adapter type is available
max. 300mm

Applicable Machines
Milling / drilling / lathe / electric hand tool

Efficiency
300%
UP

Durability
500~1000%
UP

Product Design

CUTTING.
RANGE
Ø4.0~Ø110 mm

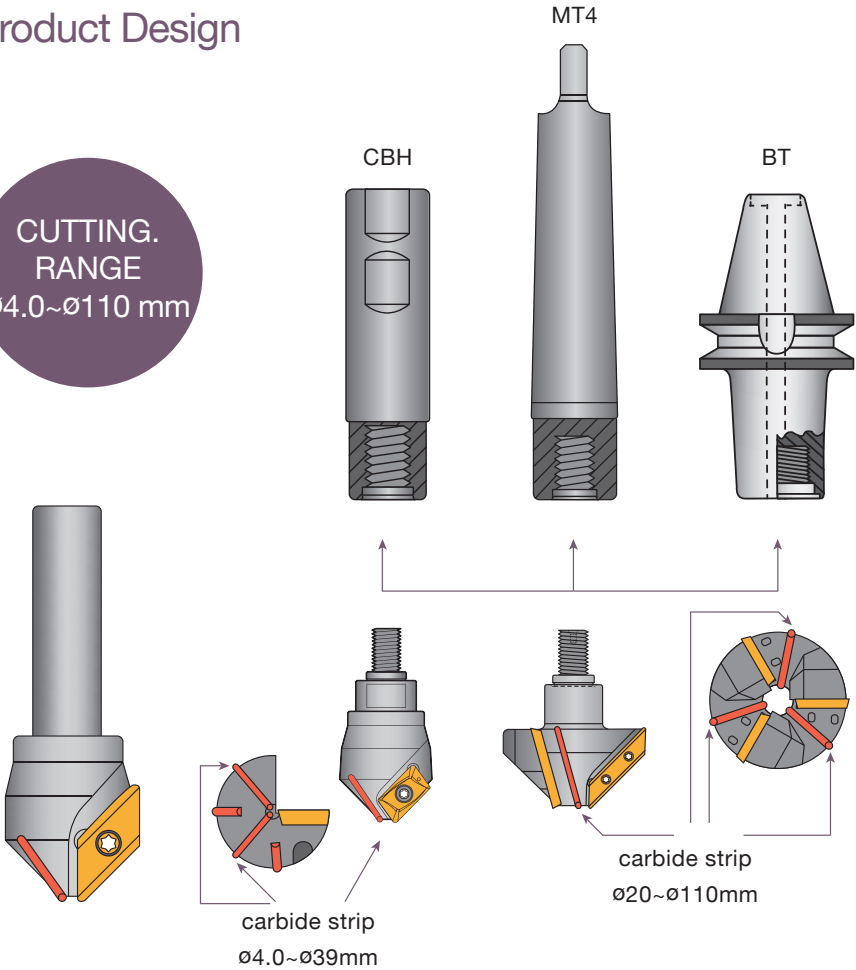

Carbide Strip Cutter With Carbide Inserts:

- Special design for unstable drilling machines and electric drills. It's working well even in lower RPM.
- Carbide strips support better tool life.
- The carbide insert performs a better tool life. It was designed with 2 cutting edges, one insert grade suitable for all materials, tend to be more economical.
- Patented carbide strip cutter design provides an excellent chamfering surface.



New coming shank

The shank with three flat designs is more suitable for drilling machine (three-jaw chuck) which achieves stable clamping and longer tool life.



▲ Optimal surface finishing

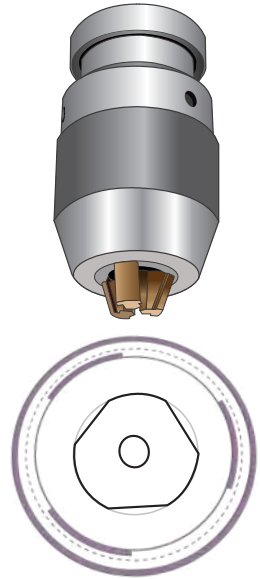

▲ Top view of the shank

Geometries Application



Standard chamfer with 90°

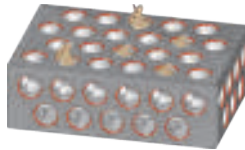

- Excellent Design
- No burrs.



Chamfer cutter with longer shank



Chamfer with 120° used for tap holes, which reduce the loss of threads.



Chamfer with 60° used for deburring before "pin". 60° chamfer is easier than 90° or 120° to locate the pin.

Applicable Machine And Tools

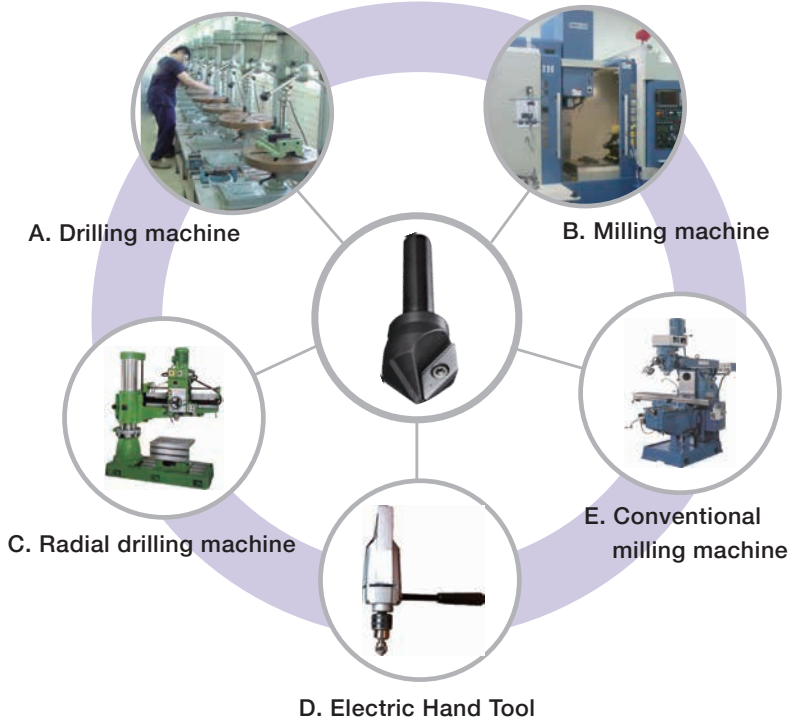

Cost Effective Solution

Coated carbide insert provides excellent tool life. Insert with 2 cutting edges maximizes tool cost-saving.

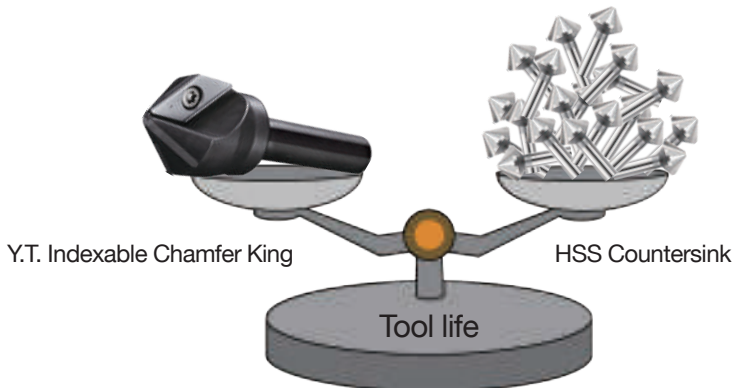

PRODUCT SPECIFICATIONS

Chamfer King Toolholders

- Inserts P. 308
- Cutting Data P. 309 - 310

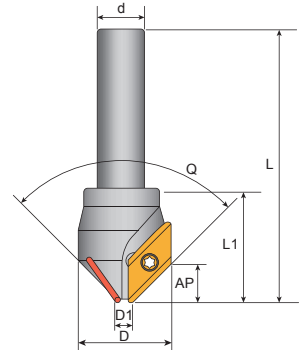

CI

- 60°

Order Code	Dimensions (mm)						Q	Z	KG	MAX RPM	Inserts XDGT	Screw	Key
	D1	D	d	L	AP	L1							
CI-17-60°	7	17	10	65	8.5	27	60°	1	0.12	35000	120308	C03506	T10P
CI-31-60°	15.5	31	12	78	13	35			0.24	25000	190408	C04011	T15P

- 90°

Order Code	Dimensions (mm)						Q	Z	KG	MAX RPM	Inserts ADGT/XDGT	Screw	Key	
	D1	D	d	L	AP	L1								
CI-12-90°	4	10	10	60	3	14	90°	1	0.08	45000	060204	C018035	T06P	
CI-12-90° -L				90					0.10					
CI-22-90°	5.5	22	65	8	27	0.14			35000	120308	C03506	T10P		
CI-36-90°	15	36	12	78	10	38			2	0.32	25000	190408	C04011	T15P
CI-36-90° -2										0.33				

- 100°

Order Code	Dimensions (mm)						Q	Z	KG	MAX RPM	Inserts ADGT/XDGT	Screw	Key	
	D1	D	d	L	AP	L1								
CI-12-100°	4	10	10	60	3	14	100°	1	0.05	45000	060204	C018035	T06P	
CI-24-100°	5	24		65	7.5	27			0.15					35000
CI-38-100°	15	38	12	78	10	38			2	0.40	25000	190408	C04011	T15P
CI-38-100° -2										0.41				

- 120°

Order Code	Dimensions (mm)						Q	Z	KG	MAX RPM	Inserts XDGT	Screw	Key
	D1	D	d	L	AP	L1							
CI-26-120°	7	26	10	65	5	27	120°	1	0.18	35000	120308	C03506	T10P
CI-39-120°	11	39	12	78	8	35			0.36				

- Insert is included with purchase of a chamfer king.

Chamfer King Toolholders

- Combi holders P. 307
- Inserts P. 308
- Cutting Data P. 309 - 310

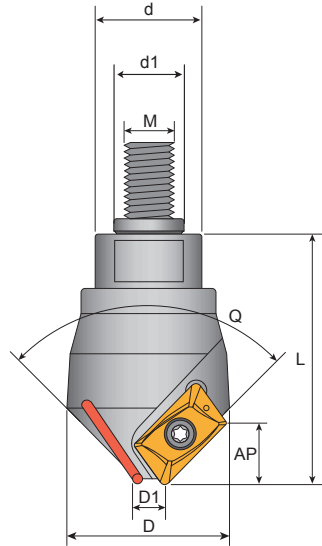

HCI

- 60°

Order Code	Dimensions (mm)							Q	Z	KG	MAX RPM	Inserts XDGT	Screw	Key
	D1	D	d	d1	L	AP	M							
HCI-17-60°	7	17	12	6.5	37	8.5	6	60°	1	0.12	35000	120308	C03506	T10P
HCI-31-60°	15.5	31	16	8.5	45	13	8			0.24	25000	190408	C04011	T15P

- 90°

Order Code	Dimensions(mm)							Q	Z	KG	MAX RPM	Inserts ADGT/XDGT	Screw	Key
	D1	D	d	d1	L	AP	M							
HCI-12-90°	4	10	10	6.5	24	3	6	90°	1	0.08	45000	060204	C018035	T06P
HCI-22-90°	5.5	22	12		37	8				0.14	35000	120308	C03506	T10P
HCI-36-90°	15	36	16	8.5	48	10	8			0.32	25000	190408	C04011	T15P

- 120°

Order Code	Dimensions(mm)							Q	Z	KG	MAX RPM	Inserts XDGT	Screw	Key
	D1	D	d	d1	L	AP	M							
HCI-26-120°	7	26	12	6.5	37	5	6	120°	1	0.18	35000	120308	C03506	T10P
HCI-39-120°	11	39	16	8.5	45	8	8			0.36	25000	190408	C04011	T15P

- Insert is included with purchase of a chamfer king.



Chamfer King Toolholders

- Combi holders P. 307
- Insert P. 308
- Cutting Data P. 309 - 310

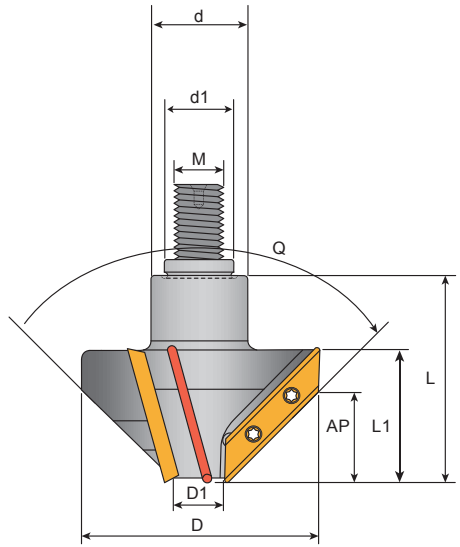

HCI

- 90°

Order Code	Dimensions (mm)									Z	KG	MAX RPM	Inserts XDGT	Screw	Key
	D1	D	d	d1	L	AP	L1	M	Q						
HCI-76-90°	20	76	30	22	65	28	41	16	90°	3	0.85	13700	400408	C04011	T15P
HCI-110-90°	55	110									1.55	10900			

Note:

- For clunker radial drilling machine which is too stiff to position at the hole center of workpiece it might cause vibration and poor surface finishing during machining.

- For workpieces which are heavy and difficult to align the toolcenter, it might cause vibration and results in chatter marks on the chamfering surface.



Chamfer King Combi Toolholders

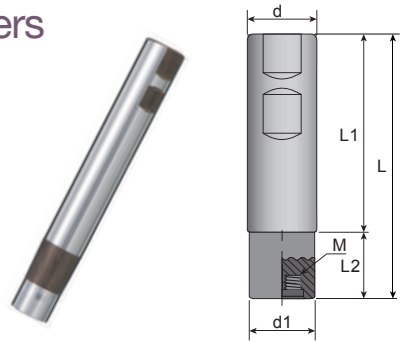

CBH

Order Code	Dimensions (mm)						
	d	d1	L1	L2	L	M	KG
CBH-1009-100	10	9	60	20	80	M6	0.05
CBH-1211-120	12	11	80		100		0.09
CBH-1211-140			100		120		0.11
CBH-1616-100	16	16	-	-	70	M8	0.11
CBH-1615-120		15	70	20	90		0.14
CBH-1615-150			95	25	120		0.18
CBH-3232-120	32	32	-	-	80	M16	0.48
CBH-3230-140		30	80	20	100		0.56
CBH-3230-200			130	30	160		0.92
CBH-3230-240			170		200		1.16
CBH-3230-300			210	50	260		1.53

MTH

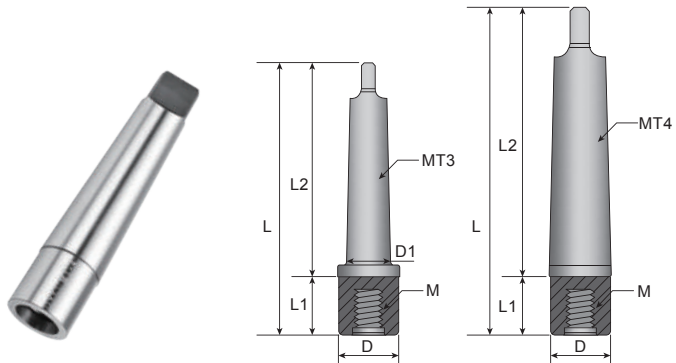

Chamfer

Order Code	Dimensions (mm)							
	D	D1	L	L1	L2	M	MT	KG
MTH-3	30	23.83	140	40	100	M16	3	0.50
MTH-4	31.6	-	165		125	M16	4	0.60





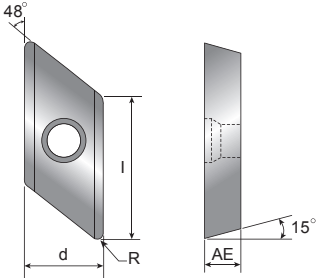

XDGT Chamfer King Insert



Tolerances (mm)

d AE
 ± 0.015 ± 0.015

Code	Dimensions (mm)				
	l	d	AE	R	Angle
120308	13	8.3	3.10	0.8	48°
190408	16	10.45	4.45		
400408	40		4.70		

Inserts	Order Code	Grades											
		Coated					Cermet			Uncoated			
		B100	C200	C250	F20	F30	CE25	CE100	CE60	K10	CE		
	XDGT120308TR-ME-C	★											 Inserts 10 PCS / Box
	XDGT190408TR-ME	★											
	XDGT400408TR-ME	★											

★ All Materials

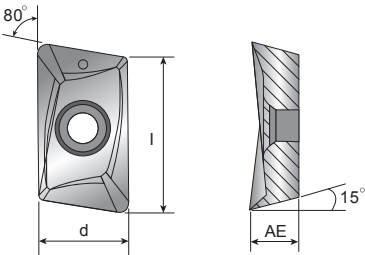

ADGT Chamfer King Insert



Tolerances (mm)

d AE
 ± 0.015 ± 0.015

Code	Dimensions (mm)		
	d	l	AE
060204	4.15	6.5	2.6

Inserts	Order Code	Grades											
		Coated					Cermet			Uncoated			
		B100	C200	C250	F20	F30	CE25	CE100	CE60	K10	CE		
	ADGT060204TR-ME-C	★											 Inserts 10 PCS / Box

★ All Materials

TECHNICAL GUIDE

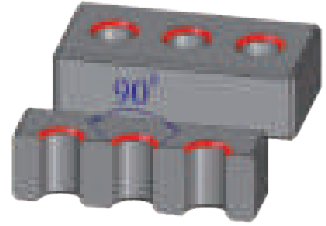

• Cutting data for hole countersinking

Material group																						
Dia. of Hole (ϕ mm)	Steel		Harden steel	Stainless steel	Cast iron			Aluminum			Titanium alloy Ni based superalloy Co-based superalloys											
	1	2	3	4	5	6	7	8	9	10	11	12	13	14	15	16	17	18	19	20	21	22
	Vc: 20 m/min Fn: 0.1 mm/rev				Vc: 15 m/min Fn: 0.12 mm/rev				Vc: 50 m/min Fn: 0.15 mm/rev				Vc: 20 m/min Fn: 0.1 mm/rev									
	RPM rev/min		Feed mm/min		RPM rev/min		Feed mm/min		RPM rev/min		Feed mm/min		RPM rev/min		Feed mm/min							
		1 Tooth	3 Teeth			1 Tooth	3 Teeth			1 Tooth	3 Teeth			1 Tooth	3 Teeth							
5~7	1062		106	-		796	96	-		2654	398	-		796	80	-						
8~10	708		71	-		531	64	-		1769	265	-		531	53	-						
11~13	531		53	-		398	48	-		1327	199	-		398	40	-						
14~16	425		42	-		318	38	-		1062	159	-		318	32	-						
17~19	354		35	-		265	32	-		885	133	-		265	27	-						
20~22	303		30	91		227	27	82		758	114	341		227	23	68						
23~25	265		27	80		199	24	72		663	100	299		199	20	60						
26~28	236		24	71		177	21	64		590	88	265		177	18	53						
29~31	212		21	64		159	19	57		531	80	239		159	16	48						
32~34	193		19	58		145	17	52		483	72	217		145	14	43						
35~37	177		18	53		133	16	48		442	66	199		133	13	40						
38~40	163		16	49		122	15	44		408	61	184		122	12	37						
41~43	152		-	45		114	-	41		379	-	171		114	-	34						
44~46	142		-	42		106	-	38		354	-	159		106	-	32						
47~49	133		-	40		100	-	36		332	-	149		100	-	30						
50~52	125		-	37		94	-	34		312	-	141		94	-	28						
53~55	118		-	35		88	-	32		295	-	133		88	-	27						
56~58	112		-	34		84	-	30		279	-	126		84	-	25						

Chamfer



Technical Guide

Material group																								
Dia. of Hole (ϕ mm)	Steel			Harden steel	Stainless steel		Cast iron			Aluminum			Titanium alloy Ni based superalloy Co-based superalloys											
	1	2	3	4	5	6	7	8	9	10	11	12 13 14 15			16 17 18			19 20 21 22						
	Vc:20 m/min Fn:0.1 mm/rev						Vc:15m/min Fn:0.12mm/rev						Vc:50m/min Fn:0.15mm/rev						Vc:20m/min Fn:0.1mm/rev					
	RPM		Feed mm/min		RPM	Feed mm/min		RPM		Feed mm/min		RPM	Feed mm/min		RPM	Feed mm/min								
rev/min	1 Tooth	3 Teeth	rev/min	1Tooth		3Teeth	rev/min	1Tooth	3Teeth	rev/min	1Tooth		3Teeth	rev/min		1Tooth	3Teeth							
59~61	106	-	32	80	-	29	265	-	119	80	-	24												
62~64	101	-	30	76	-	27	253	-	114	76	-	23												
65~67	97	-	29	72	-	26	241	-	109	72	-	22												
68~70	92	-	28	69	-	25	231	-	104	69	-	21												
71~73	88	-	27	66	-	24	221	-	100	66	-	20												
74~76	85	-	25	64	-	23	212	-	96	64	-	19												
77~79	82	-	24	61	-	-	204	-	92	61	-	18												
80~82	79	-	24	59	-	-	197	-	88	59	-	18												
83~85	76	-	23	57	-	-	190	-	85	57	-	17												
86~88	73	-	22	55	-	-	183	-	82	55	-	16												
89~91	71	-	21	53	-	-	177	-	80	53	-	16												
92~94	68	-	21	51	-	-	171	-	77	51	-	15												
95~97	66	-	20	50	-	-	166	-	75	50	-	15												
98~100	64	-	19	48	-	-	161	-	72	48	-	14												
101~103	62	-	19	47	-	-	156	-	70	47	-	14												
104~106	61	-	18	45	-	-	152	-	68	45	-	14												
107~109	59	-	18	44	-	-	147	-	66	44	-	13												
110	58	-	17	43	-	-	145	-	65	43	-	13												

CHAMFER MILLING CUTTERS SERIES



PATENTED

Features

Available in materials



Cost
100~300%
SAVING

Applicable
Machines
CNC Milling machine

Efficiency
300%
UP

Durability
300%
UP



Chamfer Milling Cutters

- Inserts P. 325
- Cutting Data P. 326 - 327

C

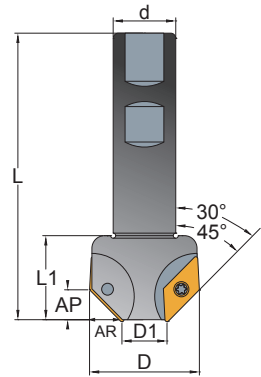

Order Code	Dimensions (mm)							Z	 KG	MAX RPM	Inserts XDGT	Screw	Key
	D	D1	d	L	L1	AP	AR						
C-1124-30°	24	10	20	80	30	10	5	2	0.23	35000	120308	C03506	T10P
C-1633-30°	33	16	25	95	35	14	7.5		0.42	25000	190408	C04008	T15P
C-2260-30°	60	22	32	120	55	33	18.5	3	0.88	8500	400408	C04011	
C-1128-45°	28	10	20	80	30	8	8	2	0.28	35000	120308	C03506	T10P
C-1740-45°	40	17	25	95	35	11	11		3	0.48	25000	190408	C04008
C-1770-45°	70	17	32	110	50	28	28	0.96		8500	400408	C04011	

Product Applications

Type of operation

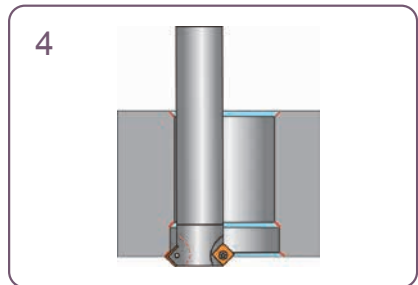
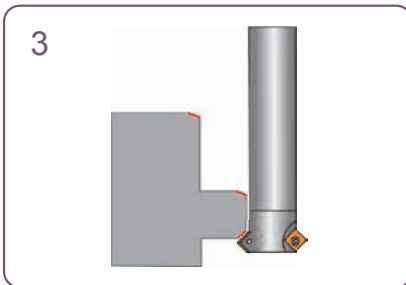
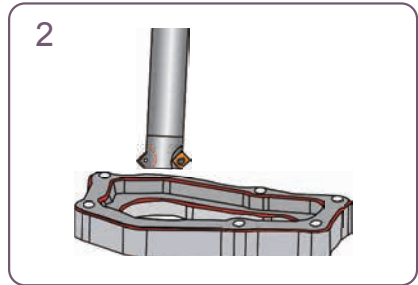
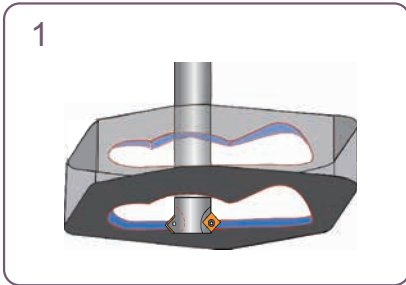
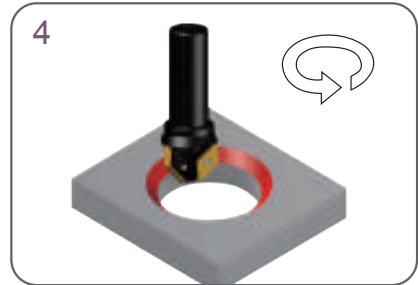
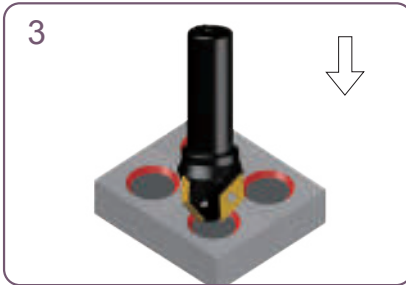
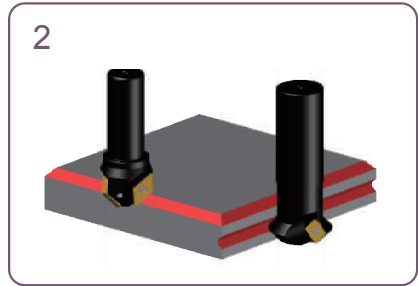
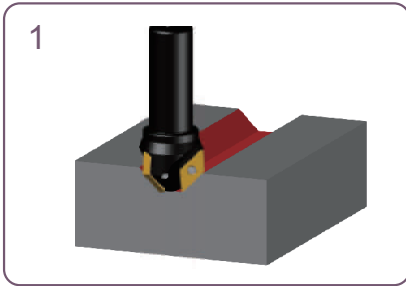

Dual Chamfer Milling Cutters

- Inserts P. 315
- Cutting Data P. 315
- Combi Toolholders P. 335 - 336

MC/HMC

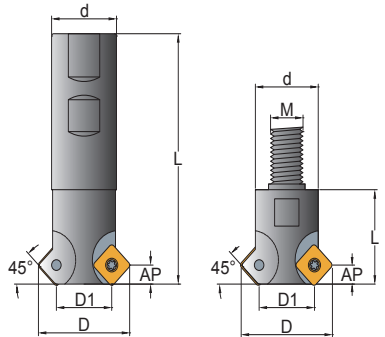

Order Code	Dimensions (mm)						Z	KG	MAX RPM	Inserts SDET	Screw	Key
	D	D1	d	L	AP	M						
MC-1218	18	11	12	90	3	-	2	0.12	35000	060208	C025045	T08P
MC-1625	25	19	16	100		-	3	0.21	25000			
MC-2032	32	22	20		6	-	2	0.31	17000	09T308	C04008	T15P
HMC-18	18	11	11	20	3	6	2	0.06	35000	060208	C025045	T08P
HMC-25	25	19	15	30		8	3	0.09	25000			
HMC-32	32	22	19			6	10	2	0.17	17000	09T308	C04008

SDET Inserts

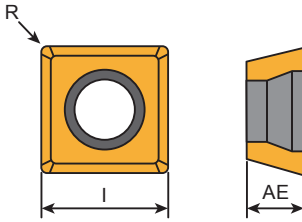

Tolerances (mm)
 I AE
 ±0.03 ±0.025

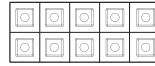

Inserts 10 PCS / Box

Code	Dimensions (mm)		
	I	AE	R
060208	6.0	2.3	0.3
09T308	9.0	3.97	0.5

Inserts	Order Code	Grades								
		Carbide					Metal cermet		Uncoated	
		B100	C200	C250	F20	F30	CE25	CE60	K10	CE
	SDET060208N-ME	⊗								
	SDET09T308TN-M	⊗								
	SDET09T308TN-ME	⊗								

- Steel Stainless Steel Steel/Stainless Steel/Super alloy Cast Iron Aluminum Steel/Cast Iron
- Steel/Stainless Steel/Cast Iron
- Prices and stocks are based on present conditions
- Please specify model numbers and the grade of inserts, i.e.: SDET060208N-ME,B100

Recommended Cutting Data Insert Grades

Material Group	Recom. fz (mm/tooth)	Cutting Speed Vc (m/min)	Grades		
			SDET... M	SDET...ME	
1	0.08-0.20		-	B100	-
2	0.08-0.18	130 160 185	-	B100	-
3	0.08-0.18		-	B100	-
4	0.08-0.15	120 140 160	-	B100	-
5	0.06-0.13		-	B100	-
6	0.06-0.12	100 120 140	-	B100	-
7	0.08-0.18		B100	B100	-
8	0.08-0.15	65 80 90	-	B100	-
9	0.07-0.13		-	B100	-
10	0.06-0.12	60 70 80	-	B100	-
11	0.10-0.22		-	B100	-
12	0.10-0.22	100 120 140	-	F30	-
13	0.10-0.15		-	F30	-
14	0.10-0.15		-	F30	-
15	0.05-0.20		-	F30	-
16	0.05-0.20	400 500 600	-	-	-
17	0.06-0.10		-	-	-
18	0.06-0.15		-	-	-
19	0.05-0.08		-	B100	-
20	0.05-0.08	30 40 50	-	B100	-
21	0.06-0.10		-	B100	-
22	0.05-0.06		-	B100	-

Chamfer



CORNER ROUNDING CUTTER-390 SYSTEM



PATENTED

Patent No.
M473882
M474588
M473881

Patent No.
201310453057.2
201320772697.5

 PCT Priority



Video

Features

Available in
materials



Cost
300~500%
SAVING

Applicable
Machines
Milling

Efficiency
300%
UP

Durability
300%
UP

Product Design

390 SYSTEM

- Max.eccentricity: $\pm 0.008\text{mm}$
Accurate center positioning achieves excellent radius surface.
- 2 effective teeth.
- One shank fits max. 10 different inserts.
- The shank in $\varnothing 25\text{mm}$ are applicable with big radius inserts R6. R7. R8. R9. R10. that achieves marvellous productivity.

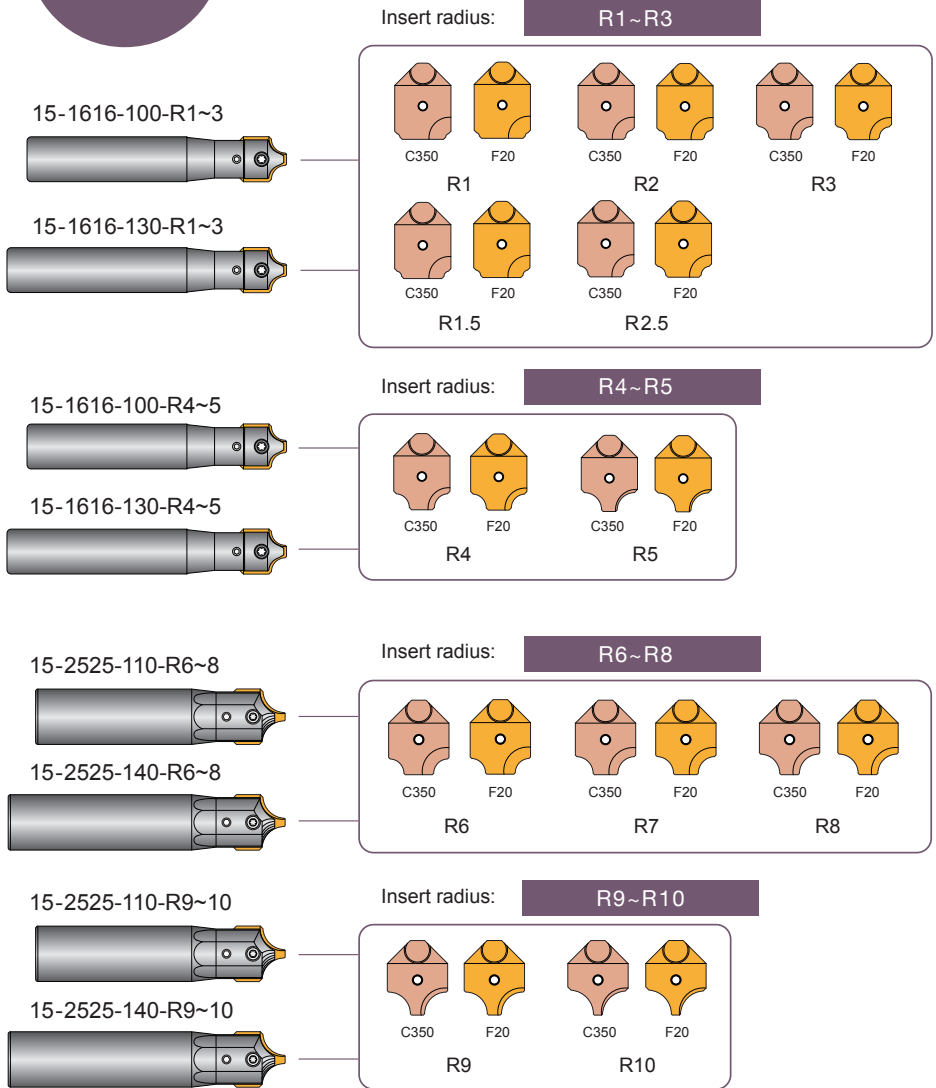

Chamfer



Indexable Corner Rounding Toolholders

- Inserts P. 319
- Cutting Data P. 321

15

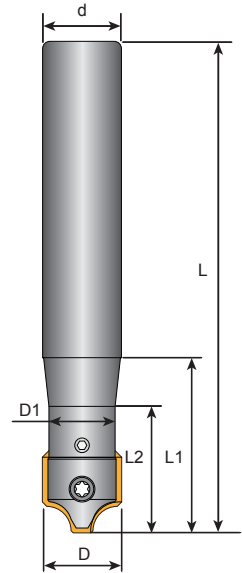

Order Code	Dimensions (mm)						KG	Inserts	Screw	Key
	D	D1	d	L	L1	L2				
15-1616-100-R1-3	16	14	16	100	35	25	0.21	R1-3	C03511 S0404	T10P L02
15-1616-130-R1-3				130			0.27			
15-1616-100-R4-5				100			0.21	R4-5		
15-1616-130-R4-5				130			0.27			
15-2525-110-R6-8	25	22	25	110	40	30	0.44	R6-8	C04017 S0508	T15P L025
15-2525-140-R6-8				140			0.58			
15-2525-110-R9-10				110			0.44	R9-10		
15-2525-140-R9-10				140			0.58			

25 Carbide Inserts



Inserts 6 PCS / Box
Only for insert :25-25***



Inserts 10 PCS / Box

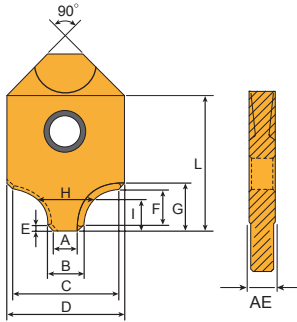

Tolerances (mm)

D : ± 0.05 AE : $\begin{matrix} +0.01 \\ -0.02 \end{matrix}$

Dimensions (mm)											
R	A	B	C	D	E	F	G	H	I	L	AE
1.0	12.0	13.29	15.17	16.30	0.64	0.96	2.33	13.86	1.30	21.5	3.0
1.5	11.0	12.29	15.16		0.67	1.47	2.85	13.15	1.69		
2.0	10.0	11.30	15.15		0.68	1.97	3.36	12.27	2.09		
2.5	9.00	10.31			0.67	2.47	3.85	11.74	2.39		
3.0	7.94	9.28	15.14		0.64	3.01	4.39	10.98	2.74		
4.0	6.00	7.29	15.09		0.67	3.97	5.37	9.58	3.45		
5.0	4.92	5.14	15.04	0.66	4.99	6.36	8.04	4.17			
6.0	11.2	12.38	24.15	25.15	0.58	5.96	7.16	15.84	4.76	30.0	3.5
7.0	9.20	10.30	24.08		0.55	6.96	8.14	14.35	5.44		
8.0	7.06	8.20	24.32		0.54	7.97	9.13	12.95	6.20		
9.0	4.80	5.93	23.98		0.56	9.00	10.18	11.22	6.93		
10.0	3.00	3.78	23.96		0.59	10.0	11.23	9.70	7.69		

Inserts	Order Code	Grades									
		Carbide					Cermet			Uncoated	
		C125	C200	C350	F20	F30	CE25	CE100	CE60	K10	CE
	25-1603-R1.0-E										
	25-1603-R1.5-E										
	25-1603-R2.0-E										
	25-1603-R2.5-E										
	25-1603-R3.0-E										
	25-1603-R4.0-E										
	25-1603-R5.0-E										
	25-2503-R6.0-E										
	25-2503-R7.0-E										
	25-2503-R8.0-E										
	25-2503-R9.0-E										
	25-2503-R10-E										
	25-1603-R1.0-ME			☉							
	25-1603-R1.5-ME			☉							
	25-1603-R2.0-ME			☉							
	25-1603-R2.5-ME			☉							
	25-1603-R3.0-ME			☉							
	25-1603-R4.0-ME			☉							
	25-1603-R5.0-ME			☉							
	25-2503-R6.0-ME			☉							
	25-2503-R7.0-ME			☉							
	25-2503-R8.0-ME			☉							
	25-2503-R9.0-ME			☉							
	25-2503-R10-ME			☉							

- Steel Stainless Steel ☉ Steel/Stainless Steel/Super alloy Cast Iron Aluminum Steel/Cast Iron
- ☉ Steel/Stainless Steel/Cast Iron

- Prices and stocks are based on present conditions
- Please specify model numbers and the grade of inserts, ie.: 25-1603-R1.0-E,F20

How to Fit Insert - Screw A.B.C.

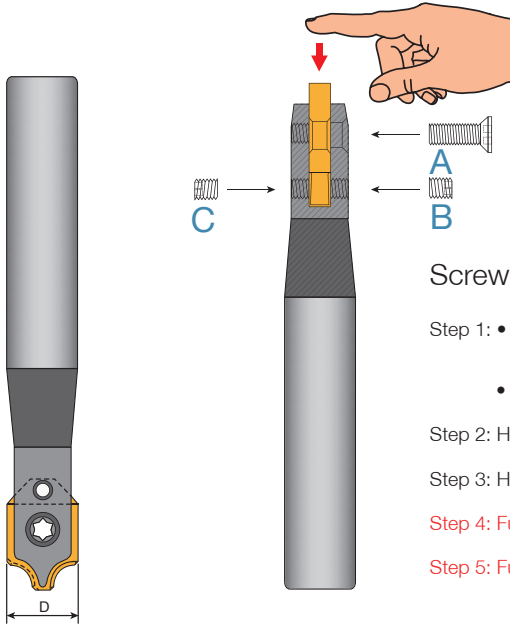

Screwing the Inserts

- Step 1: • Slot the insert into the shank and push against on the bottom.
 - Fully tighten the screw A first
- Step 2: Half tighten the screw B on one side
- Step 3: Half tighten the screw C on other side
- Step 4: Fully tighten the screw B again (Important)
- Step 5: Fully tighten the screw C again (Important)

Standard spare parts

Insert dimension D (mm)	Screw A	Screw B/C	Key	Key
 16				
25	C03510	S0404	T10P	L02
25	C04017	S0508	T15P	L025

Recommended Cutting Data And Insert Grades

Material group	Recom. fz (mm/tooth) AR/Dc = 10%	Grades	
		ME	E
1	0.10-0.12	C350	-
2	0.10-0.12	C350	-
3	0.08-0.12	C350	-
4	0.07-0.10	C350	-
5	0.07-0.10	C350	-
6	0.06-0.08	C350	-
7	0.05-0.06	C350	-
8	0.10-0.12	C350	-
9	0.10-0.12	C350	-
10	0.08-0.10	C350	-
11	0.08-0.10	C350	-
12	0.12-0.15	C350	-
13	0.12-0.15	C350	-
14	0.10-0.12	C350	-
15	0.10-0.12	C350	-
16	0.08-0.10	-	F20
17	0.08-0.10	-	F20
18	0.08-0.10	-	F20

- Recommended cutting speed, Vc(m/min), Fz(mm/ tooth) in CHAMFERING process. The effective no. of teeth is calculated with 2 flutes.

Material group	Grades						
	C250	C350			CE60	F20	
		0.07	0.10	0.14			
1	-	207	186	167	-	-	
2	-	186	167	150	-	-	
3	-	167	150	135	-	-	
4	-	150	135	120	-	-	
5	-	135	120	109	-	-	
6	-	120	108	97	-	-	
7	-	48	43	-	-	-	
8	-	160	-	80	-	-	
9	-	160	-	80	-	-	
10	-	80	-	50	-	-	
11	-	80	-	50	-	-	
12	-	170	145	125	-	-	
13	-	155	125	115	-	-	
14	-	110	90	82	-	-	
15	-	110	90	-	-	-	
16	-	-	-	-	1080	900 780	
17	-	-	-	-	950	900 770	
18	-	-	-	-	950	900 770	

Chamfer



DOVETAIL MILLING CUTTERS SERIES

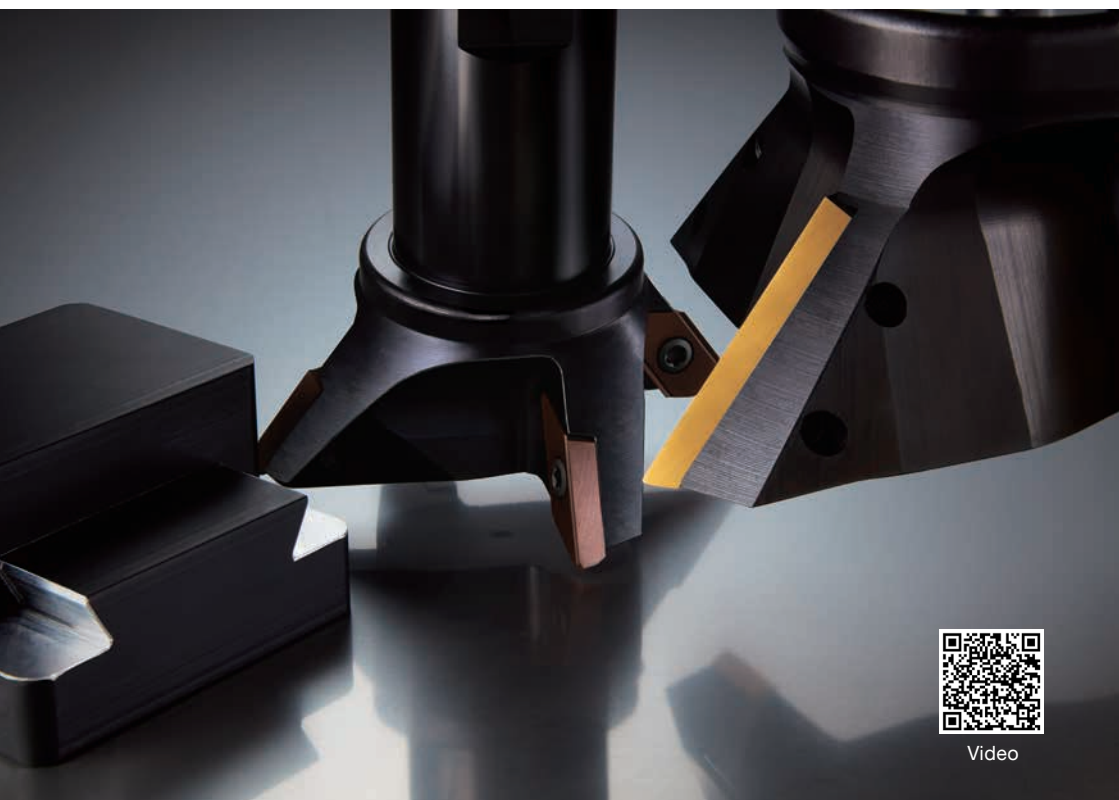

Video

Features

Available in materials



Cost
100~300%
SAVING

Applicable
Machines
CNC Milling machine

Efficiency
300%
UP

Durability
300%
UP

PRODUCT SPECIFICATIONS

Dovetail Toolholders

- Inserts P. 325
- Cutting Data P. 326 - 327

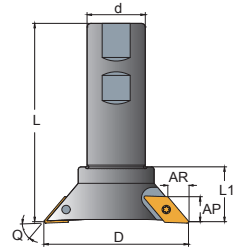
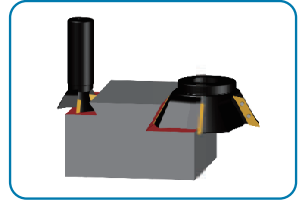

XD

Order Code	Dimensions (mm)							Z	KG	MAX. RPM	Inserts XDGT	Screw	Key
	D	d	Q	L	AP	AR	L1						
XD2040-45	40	20	45	100	9.5	7	30	2	0.31	17000	120308	C03506	T10P
XD2040-50			50		10	8							
XD2040-55			55		10.5	7							
XD2040-60			60		11	6							
XD3260-45	60	32	45	110	13	10	30	3	0.76	7500	190408	C04008	T15P
XD3260-50			50		14	11							
XD3260-55			55		15	10							
XD3260-60			60		16	9							
XD3280-45	80	32	45	110	13	10	30	4	0.97	6500	190408	C04008	T15P
XD3280-50			50		14	11							
XD3280-55			55		15	10							
XD3280-60			60		16	9							

Dovetail



Dovetail Milling Cutters

- Inserts P. 325
- Cutting Data P. 326 - 327

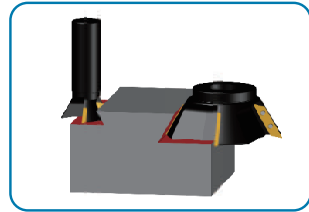

Big "AP" is available with insert XDGT40. Achieve better surface finishing.

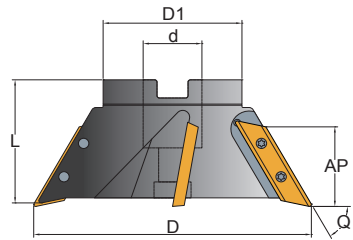

XV

Order Code	Dimensions (mm)						Z	KG	MAX. RPM	Inserts XDGT	Screw	Key
	D	D1	d	L	AP	Q						
XV120-45-25.4	120	60	25.4	55	30	45	4	1.28	6000	400408	C04011	T15P
XV120-50-25.4					31	50						
XV120-55-25.4					33	55						
XV120-60-25.4					35	60						
XV120-45-27			27		30	45						
XV120-50-27					31	50						
XV120-55-27					33	55						
XV120-60-27					35	60						

XDGT Inserts

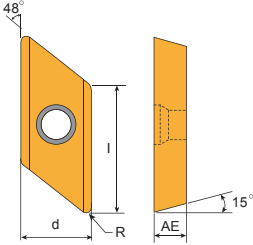

Tolerances (mm)

d ± 0.015 AE ± 0.015

Code	Dimensions (mm)				
	l	d	AE	R	Angle
120308	13	8.3	3.10	0.8	48°
190408	16	10.45	4.45		
400408	40		4.70		

Inserts	Order Code	Grades												
		Coated					Cermet			Uncoated				
		B100	C200	C250	F20	F30	CE25	CE100	CE60	K10		CE		
	XDGT120308R-E												 Inserts 10 PCS / Box	
	XDGT120308R-ME	⊙												
	XDGT120308TR-M	⊙												
	XDGT190408R-E													
	XDGT190408R-ME	⊙												
	XDGT190408TR-M	⊙												
	XDGT400408R-E													 Inserts 2 PCS / Box
	XDGT400408R-ME	⊙												
	XDGT400408TR-M	⊙												

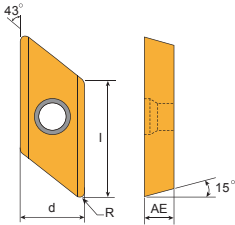

Tolerances (mm)

d ± 0.015 AE ± 0.015

* Only for 45° Dovetail Holder

Code	Dimensions (mm)				
	l	d	AE	R	Angle
120308N	11	8.3	3.10	0.8	43°
190408N	15	10.45	4.45		
400408N	40		4.70		

Inserts	Order Code	Grades												
		Coated					Cermet			Uncoated				
		B100	C200	C250	F20	F30	CE25	CE100	CE60	K10		CE		
	XDGT120308NR-E												 Inserts 10 PCS / Box	
	XDGT120308NR-ME	⊙												
	XDGT120308NTR-M	⊙												
	XDGT190408NR-E													
	XDGT190408NR-ME	⊙												
	XDGT190408NTR-M	⊙												
	XDGT400408NR-E													 Inserts 2 PCS / Box
	XDGT400408NR-ME	⊙												
	XDGT400408NTR-M	⊙												

- Steel Stainless Steel Steel/Stainless Steel/Super alloy Cast Iron Aluminum Steel/Cast Iron Steel/Stainless Steel/Cast Iron
- Prices and stocks are based on present conditions
- Please specify model numbers the and grade of inserts, ie.: XDGT120308R-E, F20



XDGT Insert Grade Selection

Material group	Recom. fz (mm/tooth)	Grades			
		XDGT ... M	XDGT ... ME	XDGT ... E	
1	0.08-0.25	-	B100	-	-
2	0.08-0.25	-	B100	-	-
3	0.08-0.25	-	B100	-	-
4	0.08-0.25	-	B100	-	-
5	0.06-0.20	-	B100	-	-
6	0.06-0.20	-	B100	-	-
7	0.08-0.15	-	B100	-	-
8	0.08-0.15	-	B100	-	-
9	0.07-0.15	-	B100	-	-
10	0.06-0.15	-	B100	-	-
11	0.10-0.15	-	B100	-	-
12	0.10-0.25	-	F30	-	-
13	0.10-0.25	-	F30	-	-
14	0.10-0.20	-	F30	-	-
15	0.05-0.20	-	F30	-	-
16	0.05-0.25	-	-	F20	-
17	0.06-0.25	-	-	F20	-
18	0.06-0.25	-	-	F20	-
19	0.05-0.08	-	B100	-	-
20	0.05-0.08	-	B100	-	-
21	0.06-0.08	-	B100	-	-
22	0.05-0.08	-	B100	-	-

Recommended Cutting Data

• Recommended Cutting speed, Vc(m/min)

Material group	Grades																	
	B100			C250			F20			CE60		CE		K10		F30		
	fz (mm/tooth)																	
	0.08	0.15	0.20	0.08	0.15	0.20	0.08	0.15	0.25							0.08	0.15	0.25
Cutting Speed, V _c (m/min)																		
1	192	152	136	-	-	-	-	-	-	-	-	-	-	-	-	-	-	-
2	168	132	116	-	-	-	-	-	-	-	-	-	-	-	-	-	-	-
3	136	118	100	-	-	-	-	-	-	-	-	-	-	-	-	-	-	-
4	124	104	84	-	-	-	-	-	-	-	-	-	-	-	-	-	-	-
5	108	92	-	-	-	-	-	-	-	-	-	-	-	-	-	-	-	-
6	92	72	-	-	-	-	-	-	-	-	-	-	-	-	-	-	-	-
7	32	28	-	-	-	-	-	-	-	-	-	-	-	-	-	-	-	-
8	108	89	79	-	-	-	-	-	-	-	-	-	-	-	-	-	-	-
9	92	76	66	-	-	-	-	-	-	-	-	-	-	-	-	-	-	-
10	76	60	54	-	-	-	-	-	-	-	-	-	-	-	-	-	-	-
11	54	45	-	-	-	-	-	-	-	-	-	-	-	-	-	-	-	-
12	-	-	-	-	-	-	-	-	-	-	-	-	-	-	-	170	145	125
13	-	-	-	-	-	-	-	-	-	-	-	-	-	-	-	155	125	115
14	-	-	-	-	-	-	-	-	-	-	-	-	-	-	-	110	90	-
15	-	-	-	-	-	-	-	-	-	-	-	-	-	-	-	90	70	-
16	-	-	-	-	-	1080	900	780	-	-	-	-	-	-	-	-	-	-
17	-	-	-	-	-	950	900	770	-	-	-	-	-	-	-	-	-	-
18	-	-	-	-	-	1080	900	780	-	-	-	-	-	-	-	-	-	-
19	50	40	-	40	32	-	-	-	-	-	-	-	-	-	-	-	-	-
20	35	30	-	28	24	-	-	-	-	-	-	-	-	-	-	-	-	-
21	50	40	-	40	32	-	-	-	-	-	-	-	-	-	-	-	-	-
22	50	40	-	40	32	-	-	-	-	-	-	-	-	-	-	-	-	-

• Type Of Inserts

	Code	Length of insert edge (mm)
	120308	11
	190408	18
	-	-
	-	-

	Code	Length of insert edge (mm)
	400408	39
	-	-
	-	-
	-	-





ALUMINIUM ALLOY FACE MILLING CUTTER



Features

Available in
materials

N

Cost
150%
SAVING

Applicable
Machines
CNC Milling machine

Efficiency
150%
UP

Durability
150%
UP

Product Design

Clamping By A Catridge Centre-Lock Clamping

Designed with adjustable catridges by which inserts held in position and fine-tunable.

Octagon insert with 8 cutting edges, the best choice for economical cost



Light aluminum alloy cutter in better stability, specially for machining non-ferrous metals in high cutting speed. It performs excellent surface finishing.

Surface Finish $Ra < 1.5 \mu m$

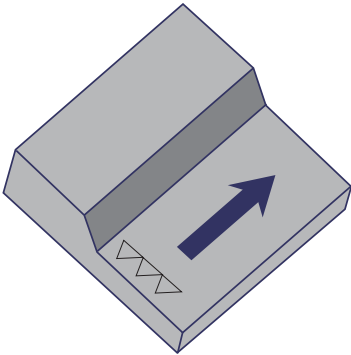

Alu-
Face Milling



Features Description

The importance of spindle accuracy in face milling.

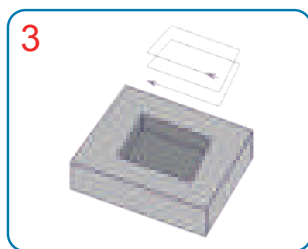
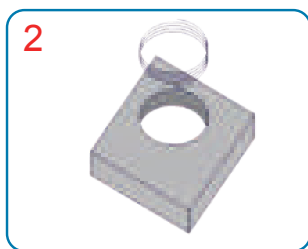
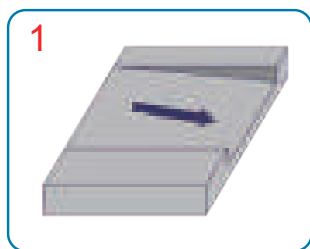
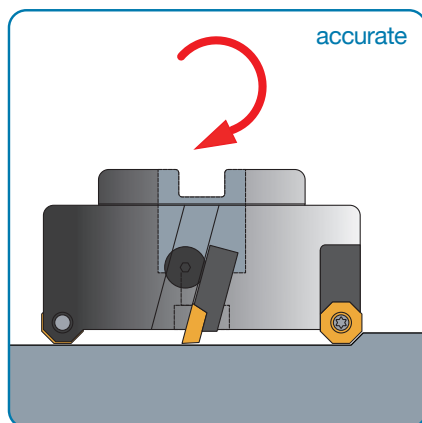
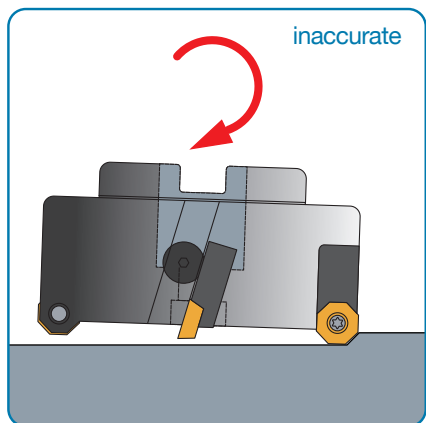

PRODUCT SPECIFICATIONS

Aluminium Alloy Face Milling Cutters

- Inserts P. 332
- Cutting Data P. 333

MO

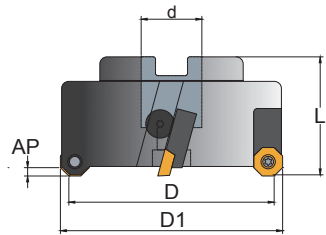

Order Code	Dimensions (mm)					Z	KG	MAX RPM	Inserts ODGT	Screw	Key
	D	D1	d	L	AP						
MO-080R-AL-C-22	80	92	22	50		5	0.68	4600	050408	C04011	T15P
MO-100R-AL-C-27	100	112	27			6	1.01	4100			
MO-125R-AL-C-27	125	137	27			7	1.60	3600			
MO-160R-AL-C-32	160	172	32	60	3	8	2.85	3100			
MO-200R-AL-C-40	200	212	40			10	4.35	2800			
MO-250R-AL-C-40	250	262				12	5.45	2500			
MO-300R-AL-C-40	300	312				14	7.95	2200			

Alu-
Face Milling





ODGT Insert



Tolerances ±0.03 (mm)

Dimensions (mm)			
Code	AE	I	AP
050408	4.7	12.7	3.5

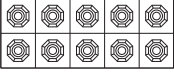
Inserts	Order Code	Grades									
		Carbide					Cermet		Uncoated		
		B100	C200	C250	F20	F30	CE100	CE60	K10		CE
	ODGT050408N-E										

Inserts 10 PCS / Box

- Steel
 Stainless Steel
 Steel/Stainless Steel /Super alloy
 Cast Iron
 Aluminum
 Steel/Cast Iron
- Steel/Stainless Steel/Cast Iron
- Prices and stocks are based on present conditions
- Please specify model numbers the and grade of inserts, ie.: ODGT050408N-E,K10

Standard Spare Parts

For Cutter					
MO-080~300	OD05AR	C04011	SL16	M0515	S0610

Recommended Insert Grades

Material group	Recom. fz (mm/tooth)	Grades			
		ODGT05 ... M	ODGT05...ME	ODGT05...E	
1	-	-	-	-	-
2	-	-	-	-	-
3	-	-	-	-	-
4	-	-	-	-	-
5	-	-	-	-	-
6	-	-	-	-	-
7	-	-	-	-	-
8	-	-	-	-	-
9	-	-	-	-	-
10	-	-	-	-	-
11	-	-	-	-	-
12	-	-	-	-	-
13	-	-	-	-	-
14	-	-	-	-	-
15	-	-	-	-	-
16	0.06-0.13	-	-	K10	-
17	0.06-0.12	-	-	K10	-
18	0.06-0.11	-	-	K10	-
19	-	-	-	-	-
20	-	-	-	-	-

Recommended Cutting Data

• Recommended Cutting speed, V_c (m/min)

Material group	Grades						
	B100	C250	F20	CE60	CE	K10	F30
	fz (mm/tooth)						
						0.13	0.25
Cutting Speed, V_c (m/min)							
1	-	-	-	-	-	-	-
2	-	-	-	-	-	-	-
3	-	-	-	-	-	-	-
4	-	-	-	-	-	-	-
5	-	-	-	-	-	-	-
6	-	-	-	-	-	-	-
7	-	-	-	-	-	-	-
8	-	-	-	-	-	-	-
9	-	-	-	-	-	-	-
10	-	-	-	-	-	-	-
11	-	-	-	-	-	-	-
12	-	-	-	-	-	-	-
13	-	-	-	-	-	-	-
14	-	-	-	-	-	-	-
15	-	-	-	-	-	-	-
16	-	-	-	-	-	1200 1000 850	-
17	-	-	-	-	-	1050 850 750	-
18	-	-	-	-	-	1200 1000 850	-
19	-	-	-	-	-	-	-
20	-	-	-	-	-	-	-
21	-	-	-	-	-	-	-
22	-	-	-	-	-	-	-

• Surface Finishing

Order Code	Feed mm / Rev <=	Ra um
ODGT050408	1.5	<1.5

Alu-
Face Milling



COMBIMASTER TOOLHOLDERS



Features

Maximum
Run Out At
3XD Is 5 μ m

Cost
150%
SAVING

Applicable
Machines
CNC Milling machine

Efficiency
150%
UP

Durability
150%
UP

PRODUCT SPECIFICATIONS

Combimaster Toolholders

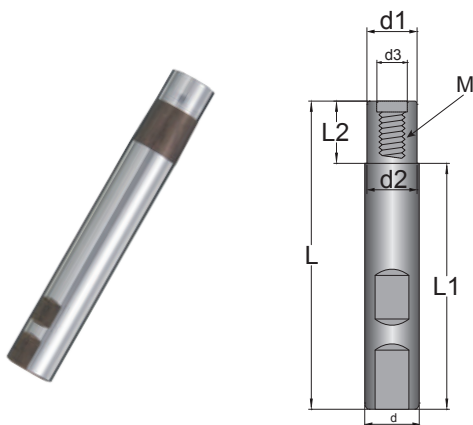

CBH

Order Code	Dimensions (mm)								KG
	d	d1	d2	d3	L1	L2	L	M	
CBH-1010-80	10	10	10	6.5	-	-	60	M6	0.04
CBH-1009-100		9	9		60	20	80		0.05
CBH-1212-80	12	12	12		60	20	100		120
CBH-1211-100		11	11	80	100			0.09	
CBH-1211-120				100	120			0.11	
CBH-1211-140				120	140			0.11	
CBH-1616-100	16	16	16	8.5	-	-	70	M8	0.14
CBH-1615-120		15	15		70	20	90		0.14
CBH-1615-150					95	25	120		0.18



Combimaster Toolholders

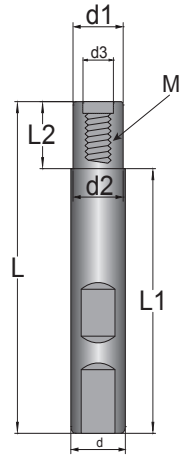

CBH

Order Code	Dimensions (mm)								
	d	d1	d2	d3	L1	L2	L	M	KG
CBH-2020-100	20	20	20	10.5	-	-	70	M10	0.16
CBH-2019-120		19	19		70	20	90		0.21
CBH-2019-160		95	25		120	0.28			
CBH-2523-130	25	23	23	14	70	20	90	M12	0.31
CBH-2523-170					100	130	0.46		
CBH-2523-210					140	30	170		0.60
CBH-2523-240					170	200	0.72		
CBH-2525-110		25	25		-	-	70		0.25
CBH-3232-120	32	32	32	22	-	-	80	M16	0.48
CBH-3230-140					80	20	100		0.56
CBH-3230-200			30		130	30	160		0.92
CBH-3230-240		30			170	50	200		1.16
CBH-3230-280			32		190	240	1.42		
CBH-3230-300					210	260	1.53		
CBH-4240-220	42	40	40	28	130	20	150	M18	
CBH-50.849-215	50.8	49	49	36				M25	2.14
CBH-50.849-265					170	30	200		2.93

Combimaster Toolholders

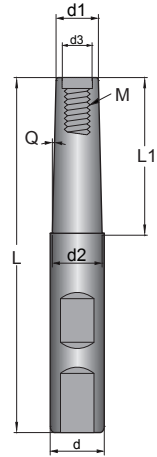

CBH

Order Code	Dimensions (mm)								
	d	d1	d2	d3	L1	L	M	Q	KG
CBH-1209-120	12	9	11.9	6.5	40	100	M6	2°	0.10
CBH-1611-120	16	11	15.5		60	130			M8
CBH-1611-150								2.5°	
CBH-2015-160	20	15	19.5	8.5	70	150	M8	2°	0.25
CBH-2015-180					80	200			0.30
CBH-2015-230					0.43				
CBH-2519-180	25	19	24	10.5	70	150	M10		0.47
CBH-2519-220					90	190			0.62
CBH-3223-200	32	23	28	14	75	160	M12		0.81
CBH-3223-240			31.5		80	200			1.10
CBH-4232-280	42	32	41.5	22	110	240	M16		2.10
CBH-4232-340					120	300			2.63
CBH-4232-410					150	370		3.00	

Accessories



APPENDIX

- RELEVANT INFORMATION





Features Description

In the following appendix you can find the trouble shooting solutions, material classification groups and choose the proper inserts grade, and cutting calculation data.

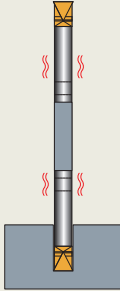

Troubleshooting

	Problem	Possible cause	Solution
	Flank wear	<ol style="list-style-type: none"> 1. Cutting speed too high 2. Feed, fz too low, 3. chip is too thin 4. Insufficient coolant 	<ol style="list-style-type: none"> 1. Reduce the cutting speed 2. Increase feed rate 3. Increase coolant flow rate 4. Climb milling 5. use coated insert
	Chipping of cutting edge	<ol style="list-style-type: none"> 1. Chip is too thick 2. Vibration 	<ol style="list-style-type: none"> 1. Reduce feed rate or increase RPM 2. Use the tangential arc method 3. Improve stability, minimize tool overhang 4. Increase number of infeed passes 5. Check toolholder run-out or insert mounting tolerance 6. Use conventional milling
	Material build up on the cutting edge	<ol style="list-style-type: none"> 1. Unsuitable carbide grade 2. Cutting zone temperature is too low 3. Very sticky material, such as low-carbon steel, stainless steels, and aluminum 	<ol style="list-style-type: none"> 1. Use a coated carbide grade 2. Increase the cutting speed 3. Increase feed rate 4. Increase coolant flow rate
	Excessive wear causing short tool life	<ol style="list-style-type: none"> 1. Vibration 2. Chips re-cutting 3. Burr formation on component 4. Poor surface finish 5. Heat generation 6. Excessive noise 	<ol style="list-style-type: none"> 1. Increase feed rate 2. Reduce the cutting speed 3. Down milling 4. Effectively evacuate chips with compressed air or cutting fluid 6. Check recommended cutting data

	Problem	Possible cause	Solution
	Vibration/runout	<ol style="list-style-type: none"> 1. Weak fixturing 2. Tool overhang too long 3. Feed rate is too high 	<ol style="list-style-type: none"> 1. Use correct cutting data 2. Check clamping of the workpiece and tool 3. Minimize overhang 4. Check tool holder run out 5. Choose a tool with fewer teeth 6. Increase number of infeed passes 7. Use up-milling in finishing
	Insufficient thread accuracy	Tool deflection	<p>Reduce feed rate Execute a "zero" cut, and make sure the tool in correct center line</p>



Material Classification Groups

• Steel

mat. group		The material group of workpieces								
W.- Nr	EN	EN-Nr	DIN	BS	AFNOR	JIS				
1	1.1133	G 28 Mn6 C10	1.1165	20 Mn5	120 M 19	20 M 5	SMnC 420			
	1.1165		30 Mn5	120 M 36						
	1.0301	C22+N	1.0401	C 10	045 M 10	AF 34 C 10; XC 10	SMn 1 H; SCMn 2			
	1.0401		C 15	080 M 15						
	1.0402		C 22	050 A 20	AF3 7 C 12; XC 18					
	1.0406		C 25	070 M 26						
	1.1121		C 15R	1.1141	Ck 10	040 A 10	C 20			
	1.1141		C 22E	1.1151	Ck 15	080 M 15				
	1.1151		S235JR	1.0037	Ck 22	040 A 22	AF 50 C 30	S 25 C		
	1.1158			Ck 25	060 A 25					
	1.0037			S235JRG2	1.0038	St 37-2	4360-40 C	XC 10	S 10 C; S 9 CK	
	1.0116			S275J0H	1.0149	St 37-3				
	1.0044	S275J2G3		1.0144	St 44-2	4360-43 B	E 24-3; E 24-4	S 15 C; S 15 CK		
	1.0144				St 44-3 N	4360-43 C				
2	1.0721	10 S 20		1.0721	10 S 20	210 M 15	10 F 1	SUM 32		
	1.0722	15 SMn13		1.0725	10 SPb 20	210 A 15	10 PbF 2			
	1.0723		15 S 20	212 M 36						
	1.0726		35 S 20	1.0726	46 S 20	212 M 44	35 MF 4			
	1.0727		46 S 20	1.0727	60 S 20	220 M 07	45 MF 4			
	1.0728	60 S 20	1.0728	9 S 20	230 M 07		60 MF 4			
	1.0711	11 SMn30	1.0715	9 SMn 28	240 M 07	S 250	SUM 21			
	1.0715		11 SMn37	1.0736	9 SMn 36				S 300	
	1.0736		11 SMnPb30	1.0718	9 SMnPb 28	S 250 Pb	SUM 22			
	1.0718		11 SMnPb37	1.0737	9 SMnPb 36				S 300 Pb	
	1.0737						SUM 22 L			
	3		1.5622	G 28 Mn6+QT	1.1165	14 Ni 6	1503-245-420		16 N 6	SB 450 M SMn 438 (H); SCMn 3
		1.5423	16 Mo 5							
		1.1167	36 Mn 5		150 M 36	40 M 5				
1.1157		40 Mn 4	080 A 30		35 M 5					
1.0528		C35+N	C 30		060 A 35	C 30	S 30 C			
1.0501			C 35		080 M 40	AF 55 C 35				
1.0511		C40+N	C 40		080 M 46	AF 60 C 40	S 40 C			
1.0503		E 335	C 45		080 M 40	AF 65 C 45	S 45 C			
1.0540		C50+N	C 50		080 M 50	C 50	S 50 C			
1.1178		C 30E	1.1178		Ck 30	060 A 30	S 30 C			
1.1181		C 35E	1.1181		Ck 35	080 M 36	S 35 C			
1.1186		C 40E	1.1186		Ck 40	080 M 40	S 40 C			
1.1206		C 50E	1.1206		Ck 50	080 M 50	XC 38 H1;XC 32			
1.1203		C 55E	1.1203		Ck 55	070 M 55				
1.0570	S355JR	1.0570	St 52-3	4360-50 C	XC 42 H1	S 55 C				
1.0535	E 360	1.0070	St 70-2		XC 48 H1	SM 50 YA				
4	1.5680	13 CrMo 4 5	1.7335	12 Ni 19	1501-620 Gr. 27	Z 18 N 5	SNC 415 (H) SNC 815 (H) SCR 415 (H) SCM 415 (H)			
	1.7012		13 Cr 2	1503-660-440				15 CD 3.5		
	1.7335		13 CrMo 4 4	14 NiCr 10	655 M 13	523 M 15		14 NC 11		
	1.7715		14 MoV 6 3						14 NiCr 14	12 NC 15
	1.5732		14 NiCr 10							
	1.5752		14 NiCr 14	15 CrMo 5	12 CD 4					
	1.7015		15 Cr 3			15 CrMoV 5 9		SNC 22		
	1.7262		15 CrMo 5						S 107	16 NC 6
	1.8521		15 CrMoV 5 9	1501-240	15 D 3					
	1.5919	15 CrNi 6	10 NC 12			SCR 415				
	1.5415	15 Mo 3					15 CD 4.5			
	1.2735	15 NiCr 14		16 MC 5						
	1.7337	16 CrMo 44	1501-620 Gr. 27		16 NC 6					
	1.7131	16 MnCr 5				527 M 17	18 NCD 6			
	1.7139	16 MnCrS 5		820 A 16						
	1.5920	16 MnCr 5	20 CrMo 2							
	1.6587	16 MnCrS 5			20 CrMo 5	20 NC 6				
	1.7311	18 CrNi 8		20 MnCr 5			SMnC 420 (H)			
	1.7264	18 CrNiMo 6	20 MnCrS 5					SMnC 21H		
1.7147	20 CrMo 5	20 MoCr 4								
1.7149	20 MnCr 5			20 MoCrS 4						
1.7321	20 MnCrS 5		21 MnCr 5		20 NC 5					
1.7323										
1.2162										

• Steel

The material group of workpieces

UNI	SS	AISI/ASTM	UNS	Condition	Misc. Brands	Structure	Form
G 22 Mn 3		1022; 1518	G10220				
C 10		1330	G13300				
C 15; C 16	1350	1010	G10100				
C 20; C 21	1450	1015	G10170				
C 25		1023	G10200				
C 10	1265	1025					
15; C 16	1370	1010	G10100				
C 20		1015	G10170				
C 25		1022					
Fe 360 B	1311	1025	G10250				
Fe 360 D FF	1312; 1313						
Fe 430 B FN	1412	A 573 Gr. 58					
Fe 430 D FF	1412; 1414	A 570 Gr. 40					
		A 573 Gr. 70					
CF 10 S 20		1108					
CF 10 SPb 20		11 L 08					
	1922						
	1957	1140	G11400				
	1973	1146	G11460				
CF 9 S 22		1212	G12120				
CF 9 SMn 28	1912	1213	G12130				
CF 9 SMn 36		1215	G12150				
CF 9 SMnPb 28	1914	12 L 13	G12134				
CF 9 SMnPb 36	1926	12 L 14	G12144				
14 Ni 6		A 350-LF 5					
16 Mo 5	2120	4520	G45200				
		1335	G13350				
		1039	G10390				
C 35	1550	1035	G10350				
C 40		1040					
C 45	1650	1045	G10430				
		1049					
		1030					
C 35	1572	1035	G10340				
C 40		1040					
		1050					
C 50		1055					
Fe 510 B; C; D	2172; 2132						
Fe 690	1655	1055					
		2515					
14 CrMo 4 5	2216	A 182-F11; F12					
16 NiCr 11		3415					
		3310; 9314	G 33106				
		5015	G 50150				
12 CrMo 4							
16 CrNi 4		4320					
16 Mo 3	2912	A 204 Gr. A					
		P6	T 51605				
14 CrMo 4 5	2216	A 387 Gr.12 Cl.2					
16 MnCr 5	2511	5115	G51170				
18 NiCrMo 7							
20 MnCr 5							
		5120	G51200				
		5120 H					

• Steel

The material group of workpieces							
mat. group	W.- Nr	EN	EN-Nr	DIN	BS	AFNOR	JIS
4	1.6523	20 NiCrMoS 2 2	1.6526	21 NiCrMo 2	805 M 20	20 NCD 2	SNCM 220 (H)
	1.7271			23 CrMoB 3 3			
	1.7218			25 CrMo 4			
	1.7325	25 CrMo 4	1.7218	25 MoCr 4	1717 CDS 110	25 CD 4 S	SCM420;SCM430
	1.7326			25 MoCrS 4			
	1.7030			28 Cr 4			
	1.6513	28 Cr4	1.7030	28 Cr 4	530 A 30		SNCM 431
	1.7707			28 NiCrMo4			
	1.6580			30 CrMoV 9			
	1.8519	31 CrMoV 9	1.8519	30 CrNiMo 8	823 M 30	30 CND 8	SNC 836
	1.5755			31 CrMov 9			
	1.7020			31 NiCr 14			
	1.7361	34 Cr 4	1.7033	32 Cr 2	653 M 31	30 NC 11	SCr 430 (H)
	1.7033			32 CrMo 12			
	1.7220			34 Cr 4			
	1.2330	34 CrMo 4	1.7220	34 CrMo 4	722 M 24	530 A 32	30 CD 12
	1.5864			35 CrMo 4			
	1.6511			35 NiCr 18			
	1.5736	36CrNiMo4+TA		36 CrNiMo 4	816 M 40	708 A 37	35 CD 4
	1.5710			36 NiCr 10			
	1.7034			36 NiCr 6			
	1.5122	38 Cr2	1.7003	37 Cr 4	640 A 35	530 A 36	35 NC 6
	1.7003			37 MnSi 4			
	1.5120			38 Cr 2			
	1.8523	41 Cr 4	1.7035	38 MnSi 4	897 M 39		38 C 2
	1.2311			39 CrMoV 13 9			
	1.2312			40 CrMnMo 7			
	1.2738	42 CrMo 4	1.7225	40 CrMnMoS 8 6	530 M 40	708 M 40	40 CMD 8S
	1.7035			40 CrMnNiMo 8			
	1.7223			41 Cr4			
	1.7045	42 CrMo 4	1.7225	42 Cr 4	708 A 40	530 A 40	42 C 4
	1.7225			42 CrMo 4			
	1.7561			42 CrV 6			
	1.5223	50 CrV 4	1.8159	42 MnV 7	708 M 40		42 CD 4 TS
	1.3563			43 CrMo 4			
	1.3561			44 Cr 2			
	1.7006	50 MnSi4	1.5131	46 Cr 2	735 A 50		42 C 2
	1.5121			46 MnSi 4			
	1.3565			48 CrMo 4			
	1.7228	55 Cr 3	1.7176	50 CrMo 4	708 A 47		SCM 445 (H)
	1.8159			50 CrV 4			
	1.5131			50 MnSi 4			
	1.5141	55 SiCr7	1.7100	53 MnSi 4	527 A 60	250 A 53	SUP 10
	1.7176			55 Cr3			
	1.0904			55 Si 7			
	1.2103	C 45W	1.0601	58 SiCr 8	800 A 62		SUP 9(A)
	1.0961			60 SiCr 7			
1.2101	62 SiMnCr4						
1.1730	C 60W	1.1191	C 45W	527 A 60	250 A 53	SUP 7	
1.1820			C 55W				
1.0601			C 60				
1.1740	C 70W1	1.1231	C 60W	080 A 62		SK7	
1.1744			C 67W				
1.1520			C 70W2				
1.1620	C 80W1	1.1248	C 70W1	080 A 62		SK 3; SK 5;	
1.1750			C 80W2				
1.1525			C 75W				
1.1625	C 85W	1.1191	C 80W1	BW 1 A		SK 6	
1.1830			C 80W2				
1.1191			C 85W				
1.1221	C 85W	1.1221	C 85W	BW 1 B		SK 5	
1.1231			Ck 45				
1.1248			Ck 60				
1.8159	C 67S	1.1231	Ck 67	080 A 62		S 45 C	
1.0060			Ck 75				
			GS-50 CrV 4				
	E 335	1.0060	St 60-2	4360-SSE; SSC		S 58 C	
			St 60-2				
	E 335	1.0060		4360-SSE; SSC		SM 58	

• Steel

The material group of workpieces							
UNI	SS	AISI/ASTM	UNS	Condition	Misc. Brands	Structure	Form
20 NiCrMo 2	2506	8620	G86170				
25 CrMo 4 (KB)	2225	4130 5130	G41300				
30 NiCrMo 8							
32 CrMo 12	2240						
34 Cr 4 (KB)		5132	G51320				
35 CrMo 4	2234	4135; 4137	G41350				
35 CrMo 4	2234	4135	T 51620				
38 NiCrMo 4 (KB)		9840	G98400				
35 NiCr 9		3435					
38 Cr 4		3135					
38 Cr 2		5135					
36 CrMoV 13 9							
41 Cr 4		P 20					
41 CrMo 4	2244	P 20+S	G51400				
42 Cr 4	2244	P 20+Ni	G41420				
42 CrMo 4	2244	5140	G41400				
		4142; 4140					
		5140					
		4142; 4140					
45 Cr 2		5045					
		5045					
51 CrV 4	2230	4150	G41470				
		6150	H61500				
55 Cr 3	2253	5155	G51550				
55 Si 8	2085; 2090	9255					
60 SiCr 8		9262					
C60		1060	G10600				
C 80 KU		W1	T72301				
C 80 KU		W 108					
C 45	1672		G10420				
C 60	1665; 1678	1064	G10640				
C 70	1770	1070	G10700				
C 75	1774; 1778	1078; 1080	G10780				
		6150H					
Fe 590; Fe 60-2							



• Steel

mat. group	The material group of workpieces						
	W.-Nr	EN	EN-Nr	DIN	BS	AFNOR	JIS
4	1.4006	X 12 Cr 13	1.4006	X 10 Cr 13	410 S 21	Z 12 C 13	SUS 410
	1.4724	X 10 CrAl 13	1.4724	X 10 CrAl 13	BH 12	Z 10 C 13	SUS 405
	1.4762	X 10 CrAl 24	1.4762	X 10 CrAl 24		Z 10 CAS 24	SUH 442
	1.4006	X 12 Cr 13	1.4006	X 12 Cr 13	410 S 21		SUS 410
	1.4104	X 14 CrMoS 17	1.4104	X 12 CrMoS 17	411 S 29	Z 10 CF 17	SUS 430 F
	1.4005	X 12 CrS 13	1.4005	X 12 CrS 13	416 S 21	Z 12 CF 13	SUS 416
	1.4024	X 12 Cr 13	1.4024	X 15 Cr 13	420 S 29	Z 12 C 13	SUS 410 J 1
	1.4521	X 2 CrMoTi18 2	1.4521	X 2 CrMoTi18 2			
	1.4521	X 2 CrMoTi18 2	1.4521	X 2 CrMoTi18 2			
	1.4003	X 2 CrNi 13	1.4003	X 2 CrNi 12			
	1.4313	X 3 CrNiMo 13 3	1.4313	X 5 CrNi 13 4	425 C 11	Z 5 CN 13.4	SCS 5
	1.4512	X 5 CrTi 12	1.4512	X 5 CrTi 12	409 S 19	Z 6 CT 12	SUH 409
	1.4000	X 6 Cr 13	1.4000	X 6 Cr 13	403 S 17	Z 6 C 12	SUS 403
	1.4016	X 6 Cr 17	1.4016	X 6 Cr 17	430 S 15	Z 8 C 17	SUS 430
	1.4002	X 6 CrAl 13	1.4002	X 6 CrAl 13	405 S 17	Z 6 CA 13	SUS 405
	1.2341	X 6 CrMo 4	1.2341	X 6 CrMo 4			
	1.4510	X 6 CrTi 17	1.4510	X 6 CrTi 17		Z 8 CT 17	SUS 430 LX
1.4511	X 3 CrNb 17	1.4511	X 8 CrNb 17		Z 8 CNb 17	SUS 430 LX	
5	1.7380	10 CrMo 9 10	1.7380	10 CrMo 9 10	1501-622 Gr. 31; 45	10 CD 9. 10	
	1.3505	100 Cr 6	1.3505	100 Cr 6	534 A 99	100 C 6	SUJ 2
	1.2510			100 MnCrW 4	BO 1	90 MWCV 5	SKS 3
	1.2833			100 V 1	BW 2	Y1 105 V	SKS 43
	1.2419	105 WCr 6	1.2419	105 WCr 6		105 WC 13	SKS 31
	1.2210	107 CrV 3	1.2210	115 CrV 3		100 C 3	
	1.2516			120 WV 4	BF 1	110 WC 20	
	1.7735	14 CrMoV 6 9	1.7735	14 CrMoV 6 9		20 CDV 5.07	
	1.5860			14 NiCr 18			
	1.7709			21 CrMoV 5 7			
	1.6746			32 NiCrMo 14 5	830 M 31	35 NCD 14	
	1.8504	34 CrAl 6	1.8504	34 CrAl 6			
	1.8507			34 CrAlMo 5	905 M 31	30 CAD 6.12	
	1.8550	34 CrAlNi 7	1.8550	34 CrAlNi 7		34 CAND 7	
	1.8506			34 CrAlS 5			
	1.6582	34 CrNiMo 6	1.6582	34 CrNiMo 6	817 M 40	35 NCD 6	SNCM 447
	1.6546			40 NiCrMo 2 2	311-Type 7	40 NCD 2	SNCM 240
	1.6565			40 NiCrMo 6	311-Type 6		SNCM 439
	1.8509	41 CrAlMo 7 10	1.8509	41 CrAlMo 7	905 M 39	40 CAD 6.12	SACM 645
	1.2542			45 WCrV 7	BS 1		
	1.2721			50 NiCr 13			
	1.8161			58 CrV 4			
	1.2826			60 MnSiCr 4			
	1.2550			60 WCrV 7		55 WC 20	
	1.7103			67 SiCr 5			
	1.2108			90 CrSi 5			
	1.1273			90 Mn 4			
	1.2842	90 MnCrV 8	1.2842	90 MnCrV 8	BO 2	90 MV 8	
	1.1545	C 105U	1.1545	C 105 W1		Y1 105	
	1.1645			C 105 W2		Y1 105	SK 3
	1.1654			C 110 W			
	1.1663			C 125 W		Y2 120	SK 2
	1.1673			C 135 W		Y2 140	SK 1
1.1274	C 100S	1.1274	Ck 101	060 A 96		SUP 4	
1.2887			GS-34 CoCrMoV 19 12				
1.2392			G-X 28 CrMoV 5 1				
1.2606			G-X 37 CrMoW 5 1				
1.4749	X 18 CrN 28	1.4749	X 18 CrN 28		Z 18 C 25		
1.2764			X 19 NiCrMo 4				
1.4021	X 20 Cr 13	1.4021	X 20 Cr 13	420 S 37	Z 20 C 13	SUS 420 J1	
1.4935	X 20 CrMoWV 12 1	1.4935	X 20 CrMoWV 12 1				
1.4057	1	1.4057	X 20 CrNi 17 2	431 S 29	Z 15 CN 16.02	SUS 431	
1.4923	X 20 CrNi 17 2	1.4923	X 22 CrMoV 12 1	762	Z 21 CDV 12		
1.4028	X 22 CrMoV 12 1	1.4028	X 30 Cr 13	420 S 45	Z 30 C 13	SUS 420 J 2	
1.2316	X 30 Cr 13	1.2316	X 36 CrMo 17		Z 35CD17		
1.4418	X 38 CrMo 16	1.4418	X 4 CrNiMo 16 5		Z 6 CND 16.05.01		
1.4031	X 4 CrNiMo 16 5	1.4031	X 40 Cr 13	(420 S 45)	Z 40 C 14	SUS 420	
	X 39 Cr 13						

• Steel

The material group of workpieces							
UNI	SS	AISI/ASTM	UNS	Condition	Misc.Brands	Structure	Form
X 12 Cr 13 X 10 CrAl 12 X 16 Cr 26	2302	410; CA-15 405 446	S41000 S40500 S44600			Martensite Ferrite	
X 10 CrS 17 X 12 CrS 13	2302 2383 2380	410 S 430 F 416	S41000 S43020 S41600 J91201			Martensite Ferrite Martensite Martensite	
X 6 CrNi 13 04 X 6 CrTi 12 X 6 Cr 13 X 8 Cr 17 X 6 CrAl 13	2326 2326 2385 2301 2320	444 444 309 409 L 403 430 405	S40977 S41500 S40900 S41008 S43000 S40500		F6NM	Ferrite Ferrite Ferrite Martensite Ferrite Ferrite Ferrite	
X 6 CrTi 17 X 6 CrNb 17		430 Ti 430 Nb	S43036			Ferrite Ferrite	
12 CrMo 9 10 100 Cr 6 95 MnWCr 5 KU 102 V 2 KU 107 WCr 5 KU 107 CrV 3 KU 110 W 4 KU	2218 2258 2140	A 182-F22 52100 O1 W 210 L2	J 21890 G51986 T31501 T 72302 T61202				
34 CrAlMo 7		A 355 CI. D	K 23545 K 52440 K 23745				
35 NiCrMo 6 (KW) 40 NiCrMo 2 (KB)	2541	4340 8740	G87400				
41 CrAlMo 7 45 WCrV 8 KU	2940 2710	4340 A 355 CI. A S1	K 24065 T41901				
55 WCrV 8 KU							
90 MnVCr 8 KU C 100 KU C 100 KU	1880	O2 W 110	T31502				
C 120 KU C 140 KU	1870	W 112 1095	G10950				
X 20 Cr 13	2322	446	S44600			Ferrite	
X 16 CrNi 16 X 22 CrMoV 12 1 X 30 Cr 13 X 38 CrMo 16 1 KU	2303 2321-03 2317 2304	420 431 420 422	S42000 S42200 S43100 J91153			Martensite Martensite Martensite Martensite Martensite	
X 40 Cr 14	2387 2304,2314	- 420	- S40280			Martensite Martensite	



• Steel

The material group of workpieces							
mat. group	W.-Nr	EN	EN-Nr	DIN	BS	AFNOR	JIS
5	1.4034	X 45 Cr 13	1.4034	X 45 Cr 13	(420 S 45)	Z 40 C 14	
	1.4873	X 45 CrNiW 18 9	1.4873	X 45 CrNiW 18 9	331 S 40	Z 35 CNWS 18.09	SUH 31
	1.2767	X 45 NiCrMo 4	1.2767	X 45 NiCrMo 4	EN 20B	45 NCD 17	
	1.4109	X 70 CrMo 15	1.4109	X 65 CrMo 14		Z 70 D 14	SUS 440A
	1.4747	X 80 CrNiSi 20	1.4747	X 80 CrNiSi 20	443 S 65	Z 80 CSN 20.02	SUH 4
1.4112	X 90 CrMoV 18	1.4112	X 90 CrMoV 18	409 S 19	Z 2 CND 18 05	SUS 440 B	
6	1.2711	54 NiCrMoV 6	1.2711	54 NiCrMoV 6	BH 224	55 NCDV 6	
	1.2713			55 NiCrMoV 6		55 NCDV 7	SKT 4
	1.2744			57 NiCrMoV 7 7			
	1.2762			75 CrMoNiW 6 7			
	1.2369			81 CrMov 42 16			
	1.2880			G-X 165 CrCoMo 12			
	1.2601			G-X 165 CrMoV 12			
	1.2201			G-X 165 CrV 12			
	1.3207	HS 10-4-3-10	1.3207	S 10-4-3-10	BT 42	Z 130 WKCDV 10-4-3-10	SKH 57
	1.3318	HS 12-1-2	1.3318	S 12-1-2			
	1.3302	HS 12-1-4	1.3302	S 12-1-4			
	1.3202	HS 12-1-4-5	1.3202	S 12-1-4-5			
	1.3355	HS 18-0-1	1.3355	S 18-0-1	BT 1		SKH 2
	1.3265	HS 18-1-2-10	1.3265	S 18-1-2-10	BT 5	Z 80 WCV 18-04-01	SKH 4 A
	1.3257	HS 18-1-2-15	1.3257	S 18-1-2-15			
	1.3255	HS 18-1-2-5	1.3255	S 18-1-2-5	BT 4		SKH 3
	1.3247	HS 2-10-1-8	1.3247	S 2-10-1-8	BM 42	Z 80 WKCW 18-05-04-0	SKH 51
	1.3346	HS 2-9-1	1.3346	S 2-9-1	BM 1	Z 110 DKCWV 09-08-04	
	1.3348	HS 2-9-2	1.3348	S 2-9-2		Z 85 DCWV 08-04-02-0	
	1.3249			S 2-9-2-8	BM 34	Z 100 DCWV 09-04-02-	
	1.3333	HS 3-3-2	1.3333	S 3-3-2			
	1.3343	HS 6-5-2	1.3343	S 6-5-2	BM 2		SKH 9; SKH 51
	1.3243	HS 6-5-2-5	1.3243	S 6-5-2-5		Z 85 WDCV 06-05-04-0	SKH 53
	1.3344	HS 6-5-3	1.3344	S 6-5-3	BM 4	Z 85 WDKCV 06-05-04-02	SKH 52; SKH 53
	1.3345	S 6-5-3C	1.3345	S 6-5-3C		Z 120 WDCV 06-05-04-	SKH 55
	1.3246	HS 7-4-2-5	1.3246	S 7-4-2-5			
	1.2363	X 100 CrMoV 5	1.2363	X 100 CrMoV 5 1	BA 2	Z 110 WKCDV 07-05-04	SKD 12
	1.4125	X 105 CrMo 17	1.4125	X 105 CrMo 17	BD 2	Z 100 CDV 5	SUS 440 C
	1.2379	X 155 CrVMo 12 1		X 155 CrVMo 12 1	BD 2	Z 100 CD 17	SKD 11
	1.2601			X 165 CrMoV 12		Z 160 CDV 12	
	1.2709			X 2 NiCoMoTi 18 9 5	BD 3		SKD 1
	1.2080	X 210 Cr 12	1.2080	X 210 Cr 12		Z 2 NKD 19-09	SKD 2
1.2436			X 210 CrW 12		Z 200 C.12		
1.2706			X 3 NiCrMo 18 8 5			SKD 4	
1.2567			X 30 WCrV 5 3	BH 21	E-Z 2 NKD 18	SKD 5	
1.2581			X 30 WCrV 9 3		Z 32 WCV 5		
1.2885			X 32 CrMoCoV 3 3 3	BH 10	Z 30 WCV 9	SKD 7	
1.2365			X 32 CrMoV 3 3	BH 11		SKD 6	
1.2343			X 38 CrMoV 5 1		Z 32 DCV 28		
1.2367			X 38 CrMoV 5 3	BH 13	Z 38 CDV 5	SKD61	
1.2344	X 40 CrMoV 5 1	1.2344	X 40 CrMoV 5 1		Z 40 CDV 5		
Hardened steel							
7	1.3401	X 120 Mn 12	1.3401	X 120 Mn 12	BW 10	Z 120 M 12	SC MnH 1
Stainless steel							
8	1.4305	X 8 CrNiS 18 9	1.4305	X 10 CrNiS 18 9	303 S 31	Z 10 CNF 18.09	SUS 303
	1.4310	X 9 CrNi 18 8	1.4310	X 12 CrNi 17 7	301 S 21	Z 12 CN 17.07	SUS 301
	1.4300	X 12 CrNi 18 8	1.4300	X 12 CrNi 18 8	302 S 25	Z 12 CN 18	SUS 302
	1.4546	X 5 CrNiNb 18 10	1.4546	X 5 CrNiNb 18 10	347 S 31		
	1.4301	X 5 CrNi 18 9	1.4301	X 6 CrNi 18 10	304 S 31	Z 6 CN 18.09	SUS 304
	1.4948	X 6 CrNi 18 11	1.4948	X 6 CrNi 18 11	304 S 51	Z 6 CN 18.09	SUS 304 H
	1.4303	X 4 CrNi 18 11	1.4303	X 6 CrNi 18 12	305 S 19	Z 8 CN 18.11 FF	SUS 305
	1.4550	X 6 CrNiNb 18 10	1.4550	X 6 CrNiNb 18 10	347 S 31	Z 6 CnNb 18.10	SUS 347
9	1.4583	X 5 CrNiMoNb 19 11 2	1.4583	X 10 CrNiMoNb 18 12	318 C 17	Z 6 CNDNb 17.13	SCS 22
	1.4335		1.4335		310 S 24	Z 12 CN 25.20	SUH 310; SUS 310 S
	1.4541	X 12 CrNi 25 21	1.4878	X 12 CrNi 25 21	321 S 51	Z 6 CNT 18.12	SUS 321
	1.4962	X 6 CrNiTi 18 10	1.4962	X 12 CrNiTi 18 9		Z 6 CnNb 18.10	
	1.4828	X 12 CrNiWTi 16 3	1.4828	X 12 CrNiWTi 16 3	309 S 24	Z 17 CNS 20.12	SUH 309
	1.4306	X 15 CrNiSi 20 12	1.4306	X 15 CrNiSi 20 12	304 S 12	Z 2 CN 18.10	SUS 304 L
	1.4404	X 2 CrNi 19 11	1.4404	X 2 CrNi 19 11	316 S 11	Z 2 CND 17.12.02	SUS 316 L
	1.4435	X 2 CrNiMo 17 12 2	1.4435	X 2 CrNiMo 17 13 2	316 S 12	Z 2 CND 17.13	SCS 16; SUS 316 L
	1.4438	X 3 CrNiMo 18 14 3	1.4438	X 2 CrNiMo 18 14 3	317 S 12	Z 2 CND 19.15.4	SUS 317L
		X 2 CrNiMo 18 15 4		X 2 CrNiMo 18 16 4			

• Steel

The material group of workpieces							
UNI	SS	AISI/ASTM	UNS	Condition	Misc. Brands	Structure	Form
X 45 CrNiW 18 9 42 NiCrMo 15 7	[2304]	- - SAE HNV 3 6F7 440 A	S44002			Martensite Martensite	
X 80 CrSiNi 20 X CrTi 12	2327	SAE HNV 6 440 B	S65006 S44003	sol. treated		Martensite PH Martensite	
HS 10-4-3-10		6F2 L6	T61206				
HS 18-0-1 HS 18-1-2-10		T15 T1 T5	T12015 T12001 T12005				
HS 18-1-1-5 HS 2-9-1-8 HS 1-8-1 HS 2-9-2	2782	T4 M42 H41; M1 M7 M33;M34	T12004 T11342 T11301 T11307 T11333				
HS 3-3-2 HS 6-5-2 HS 6-5-2-5 HS 6-5-3	2722 2723	M2 M35 M3 Cl.2 M3 M41	T11302 T11323 T11323 T11341			Martensite	
HS 7-4-2-5 X 100 CrMoV 5 1 KU X 105 CrMo 17 X 155 CrVMo 12 1 KU X 166 CrMoW 12 KU	2260 2310	A2 440 C D2	T30102 S44004 T30402				
X 210 Cr 13 KU X 215 CrW 12 1 KU	2312	18 MAR 300 D3	T30403 K 93120				
X30 WCrV 5 3 KU X30 WCrV 9 3 KU		H21	T20821				
30 CrMoV 12 12 KU X37 CrMoV 5 1 KU		H10 H11	T20810 T20811				
X 40 CrMo 5 1 1 KU	2242	H13	T20813				
Hardened steel							
	2183	A128 Grade A					
Stainless steel							
X 10 CrNi 18 09 X 12 CrNi 17 07	2346 (2331) 2331	303 301 302	S30300 S30100 S30200			Austenite Austenite Austenite	
X 6 CrNiNb 18 11 X 5 CrNi 18 11 X 5 CrNi 18 10 KW X 7 CrNi 18 10 X 6 CrNiNb 18 11	2333 2333 2333 2338	348 304; 304 H 304 H 308; 305 347	S34800 S30400 S30480 S30500 S34700			Austenite Austenite Austenite Austenite Austenite	
X 6 CrNiMoNb 17 13 X 6 CrNi 26 20 X 6 CrNiTi 18 11	2361 2337	318 310 S 321; 321H 347 H 309	S31008 S32100 S34700 S30900 S30403			Austenite Austenite Austenite Austenite Austenite	
X 3 Cr Ni 18 11 X 2 CrNiMo 17 12 2 X 2 CrNiMo 17 13 2 X 2 CrNiMo 18 16	2348 2353 2367	304 L 316 L 316 L 317 L	S31603 S31603 S31703			Austenite Austenite Austenite Austenite	



• Stainless steel

mat. group	The material group of workpieces						
	W.-Nr	EN	EN-Nr	DIN	BS	AFNOR	JIS
9	1.4311	X 2 CrNiN 18 10	1.4311	X 2 CrNiN 19 11	304 S 62	Z 2 CN 18. 10 Az	SUS 304 LN
	1.4436	X 5 CrNiMo 17 13 3	1.4436	X 5 CrNiMo 17 13 3	316 S 33	Z 6 CND 18.12.03	SUS 316
	1.4308	X 5 CrNi 19 10	1.4308	X 6 CrNi 18 9	304 C 15	Z 6 CN 18.10M	SUS 13
	1.4580	X 6 CrNiMoNb 17 12 2	1.4580	X 6 CrNiMoNb 17 12 2	318 S 17	Z 6 CNDNb 17.12	
	1.4571	X 6 CrNiMoTi 17 12 2	1.4571	X 6 CrNiMoTi 17 12 2	320 S 31	Z 6 CNDT 17.12	SUS 316 Ti
10	1.4841	X 15 CrNiSi 25 20	1.4841	X 15 CrNiSi 25 20	314 S 25	Z 15 CNS 25.20	SUH 310
	1.4401	X 5 CrNiMo 17 12 2	1.4401	X 5 CrNiMo 18 10	316 S 31	Z 3 CND 17.11.1	SUS 316
11	1.4547	X 1 CrNiMoN 20 18 7	1.4547	X 1 CrNiMoN 20 18 7	X1CrNiMoN2018 7	Incoloy 800	NCF 800
	1.4563	X 1 NiCrMoCuN 31 27 4	1.4563	X 1 NiCrMoCuN 31 27 4			
	1.4876	X 10 NiCrAlTi 32 20	1.4876	X 10 NiCrAlTi 32 20	Z 10 NC 32 21	Z 3 CHD 25.07 Az	SUH 330
	1.4864	X 12 NiCrSi 35 16	1.4864	X 12 NiCrSi 36 16			
	1.4410	X 2 CrNiMoN 25 7 4	1.4410	X 2 CrNiMoN 25 7 4	NA 17	Z 3 CHD 25.07 Az	SUS 316 LN
	1.4507	X 2 CrMoNiCuN 25 6 3	1.4507	X 2 CrMoNiCuN 25 6 3			
	1.4501	X 2 CrNiMoCuWN 25 7 4	1.4501	X 2 CrNiMoCuWN 25 7 4	316 S 61	Z 3 CND 17.12 Az	SUS 316 LN
	1.4406	X 2 CrNiMoN 17 11 2	1.4406	X 2 CrNiMoN 17 11 2			
	1.4429	X 2 CrNiMoN 17 13 3	1.4429	X 2 CrNiMoN 17 12 2	316 S 62	Z 3 CHD 18.14.05Az	(SUS 316LN)
	1.4439	X 2 CrNiMoN 17 13 5	1.4439	X 2 CrNiMoN 17 13 3			
	1.4462	X 2 CrNiMoN 22 5 3	1.4462	X 2 CrNiMoN 17 13 3	332 S 15	Z 2 CHD 22.05 Az	SUS 329 J 3L
	1.4462	X 2 CrNiMoN 22 5	1.4462	X 2 CrNiMoN 22 5			
	1.4652	X 1 CrNiMoN 25 22 8	1.4652	X 2 CrNiMoN 22 5	318 S 13	Z 2 CHD 22.05 Az	SUS 329 J 3L
	1.4362	X 2 CrNiN 23 4	1.4362	X 2 CrNiMoN 25 22 7			
	1.4539	X 2 NiCrMoCu 25 20 5	1.4539	X 2 CrNiN 23 4	904 S 13	Z 2 NCDU 25 20	SUS 329 J 1
	1.4539	X 1 NiCrMoCu 25 20 5	1.4539	X 2 NiCrMoCu 25 20 5			
	1.4540	X 4 CrNiCuNb 16 4	1.4540	X 2 NiCrMoCu 25 20 5	Z 4 CNUNb 16.4 M	Z 3 CND 25.7 Az	SUS 24;SUS 630
	1.4460	X 3 CrNiMo 27 5 2	1.4460	X 4 CrNiCuNb 16 4			
1.4542	X 5 CrNiCuNb 16 4	1.4548	X 4 CrNiMo 27 5 2	Z 6 CNU 17.4			
			X 5 CrNiCuNb 17 4				

Cast iron

12	0.6100	EN-GJL-100	0.6100	GG-10	Grade 100	Ft 10 D	FC 100
	0.6150	EN-GJL-150	0.6150	GG-15	Grade 150	Ft 15 D	FC 150
	0.7033	EN-GJS-350-22	0.7033	GGG-35.3	Grade 350/22	FGS 370-17	FCD 350-22L
	0.7040	EN-GJS-400-15	0.7040	GGG-40	Grade 420/12	FGS 400-12	FCD 400-18L
	0.7043	EN-GJS-400-18	0.7043	GGG-40.3	Grade 370/17	FGS -370-17	
13	0.6200	EN-GJL-200	0.6200	GG-20	Grade 220	Ft 20 D	FC 200
	0.6250	EN-GJL-250	0.6250	GG-25	Grade 260	Ft 25 D	FC 250
	0.7050	EN-GJS-500-7	0.7050	GGG-50	Grade 500/7	FGS 500-7	FCD 500-7
	0.7060	EN-GJS-600-3	0.7060	GGG-60	Grade 600/3	FGS 600-3	FCD 600-3
	0.7660	EN-GJSA-XNiCr20-2	0.7660	GGG-NiCr 20 2	Grade S2	FGS Ni20 Cr2	
14	0.7661	EN-GJSA-XNiCr20-3	0.7661	GGG-NiCr 20 3	Grade S2B	FGS Ni20 Cr3	
	0.7652	EN-GJLA-XNiMn 13-7	0.7652	GGG-NiMn 13 7	Grade S6	FGS Ni13 Mn7	
	0.6660	EN-GJLA-XNiCr 20-2	0.6660	GGL-NiCr 20 2	Grade F2	FGL Ni20 Cr2	
	0.6661	EN-GJLA-XNiCr 20-3	0.6661	GGL-NiCr 20 3		FGL Ni20 Cr3	
	0.6657	EN-GJMB-600-3	0.8165	GTS-65-02	P 570/3	P 570/3	PCMP60-03
15	0.6300	EN-GJL-300	0.6300	GG-30	Grade 300	Ft 30 D	FC 300
	0.7070	EN-GJS-700-2	0.7070	GGG-70	Grade 700/2	FGS 700-2	FCD 700-2
	0.6655	EN-GJLA-XNiCuCr15-6-2	0.6655	GGL-NiCuCr 15 6 2	Grade F1	FGL Ni15 Cu6 Cr2	
	0.6655	EN-GJLA-XNiCuCr15-6-3	0.6656	GGL-NiCuCr 15 6 3		FGL Ni15 Cu6 Cr3	
	0.6657	EN-GJLA-XNiCuCr15-6-3	0.8170	GTS-70-02	P 690/2	P 690/2	PCMP70-02
15	0.6350	EN-GJL-350	0.6350	GG-35	Grade 350	Ft 35 D	FC 350
	0.6040	-	0.6040	GG-40	Grade 400	Fgl 400	
	0.7080	EN-GJS-800-2	0.7080	GGG-80		FGS 800-2	FCD 800-2
	0.7670	EN-GJSA-XNi22	0.7670	GGG-Ni 22		FGS Ni22	
	0.7683	EN-GJSA-XNi35	0.7683	GGG-Ni 35		FGS Ni35	
	0.7677	-	0.7677	GGG-NiCr 30 1		FGS Ni30 Cr1	
	0.7676	EN-GJSA-XNiCr30-3	0.7676	GGG-NiCr 30 3	Grade S3	FGS Ni30 Cr3	
	0.7683	EN-GJSA-XNiCr35-3	0.7683	GGG-NiCr 35 3		FGS Ni35 Cr3	
	0.7673	EN-GJSA-XNiMn23-4	0.7673	GGG-NiMn 23 4	Grade S2M	FGS Ni23 Mn4	
	0.7665	EN-GJSA-XNiSiCr20-5-2	0.7665	GGG-NiSiCr 20 5 2		FGS Ni20 Si5 Cr2	
	0.7680	EN-GJSA-XNiSiCr30-5-5	0.7680	GGG-NiSiCr 30 5 5		FGS Ni30 Si5 Cr5	
	0.6676	EN-GJSA-XNiCr30-3	0.6676	GGL-NiCr 30 3	Grade F3	FGL Ni30 Cr3	
0.6667	EN-GJSA-XNiSiCr20-5-3	0.6667	GGL-NiSiCr 20 5 3		FGL Ni20 Si5 Cr3	A1200	
0.6680	-	0.6680	GGL-NiSiCr 30 5 5		FGL Ni30 Si5 Cr5	(A1050)	

• Stainless steel

The material group of workpieces							
UNI	SS	AISI/ASTM	UNS	Condition	Misc.Brands	Structure	Form
X 2 CrNiN 18 11 X 5 CrNiMo 17 13 2	2371 2343 2333	304 LN 316 CF8	S30453 S31600			Austenite Austenite Austenite Austenite	
X 6 CrNiMoNb 17 12 X 6 CrNiMoTi 17 12	2350	316 Cb 316 Ti	S31640			Austenite Austenite	
X 16 CrNiSi 25 20 X 5 CrNiMo 17 12	2347	314; 310 316	S31000 S31600	314 S 25 316 S 31		Austenite Austenite	
X 1 CrNiMoN 20 18 7	2778		S31254 N08028 N08800	Sol. treated	254 SMO Sanicro 28 Alloy 800	Super austenite Super austenite PH	
X 2 CrNiMoN 25 7 4	2328	330 F 53 255 F 55	N08330 S32750 S32550 S32760		Incoloy DS SAF 2507 Ferralium Zeron 100	Austenite Super duplex Super duplex Super duplex	
X 2 CrNiMoN 17 12 X 2 CrNiMoN 17 13 3	2375	316 LN 316 LN (316 LN) 329 LN	S 31653 S31653 (S31653)			Austenite Austenite Austenite	
X 2 CrNiMoN 22 5 X 2 CrNiMoN 22 5	2377 2377	329 LN 318	S31803 S32205 S32654		SAF 2205 SAF 2205 654 SMO	Duplex Duplex Super austenite	
	2327 2562 2564	- 904L CN7M	S32304 N08904		SAF 2304	Duplex Super austenite Super austenite	
X 3 CrNiMo 27 5 2	2324	XM-12 329 630	S15500 S32900 S17400	Sol. treated Sol. treated	15-5-PH 17-4-PH	PH Duplex Super austenite	

Cast iron

G10 G15	01 10-00 01 15-00 07 17-15	A18 20 B A48 25 B	F11401 F11601			GCI GCI DCI	
GS 400-12 GSO 42/17 B 35-12 P 45-06 P 55-04	07 17-02 07 17-12 08 15-00 08 52-00 08 54-00	60-40-18 60-40-18 A47 32510 A220 45008 A220 60004	F32800 F32800 F22200 F23130 F24130			DCI DCI Martensite Martensite Martensite	
G20 G25 GS 500-7 GS 600-3	01 20-00 01 25-00 07 27-02 07 32-03	A48 30 B A48 35 B A536 80-55-6 A476 80-60-03 A436 Type D-2 A436 Type D-2B	F12101 F12401 F33800 F34100 F43000 F43001			GCI GCI DCI DCI Austenite Austenite Austenite Austenite Martensite	
	07 72-00 05 23-00	- A436 Type 2 A436Type 2b	- F41002 F41003				
P65-02	08 56-00	A220 70003	F24830				
G30 GS 700-2	01 30-00 07 37-01	A48 45 B A536 100-70-03 A436 Type 1 A436 Type 1b	F13101 F34800 F41000 F41001			GCI DCI Austenite Austenite Martensite	
P 70-02	08 62-00	A220 90001	F26230				
G35 GS 800-2	01 35-00 01 40-00	A48 50 B A278 60 B A536 120-90-02 A439 Type D-2B A439 Type D-5 A436 Type D-3A A436 Type D-3 A436 Type D-5B A439 Type D-2M Nicrosilal Spheronic A439 Type D-4 A436 Type 3 Nicrosilal A436 Type D-4	F13502 F14102 F36200 F43006 F43004 F43003 F43007 F43010 - F43005 F41001			GCI GCI Martensite Austenite Austenite Austenite Austenite Austenite Austenite Austenite Austenite Austenite Austenite Austenite	



• Non-Ferrous metal

mat. group	The material group of workpieces						
	W.- Nr	EN	EN-Nr	DIN	BS	AFNOR	JIS
16	3.0205	AW-1200	Al99	Al99	1C/1200	A-4/1200	A1200
	3.0255	AW-1050A	Al99.5	Al99.5	1B/1050A	A-5/1050A	(A1050)
	3.0275	AW-1070	Al99.7	Al99.7		A-7/1070	
	3.0285	AW-1080	Al99.8	Al99.8	1A	A-8/1080	
	3.1305			AlCu2.5Mg0.5	2L69	A-U2G	
	3.1655	AW-2011	AlCuBiPb	AlCuBiPb	FC1/2011	A-U5PbBi/2011	A2011
	3.1325	AW-2024	AlCuMg1	AlCuMg1	H14	A-U4G/2024	A2017
	3.1355			AlCuMg2	2L97/98	A-U4G1	
	3.1255	AW-2014	AlCuSiMn	AlCuSiMn	H15/2014	A-U4SG/2014	
	3.3315	AW-5005A	AlMg1	AlMg1	N41/5005	A-G0.6	
	3.3316			AlMg1.5		A-G1.5	
	3.3211	AW-6061	AlMg1SiCu	AlMg1SiCu	H20	(6061)	A6061
	3.3523	AW-5052	AlMg2.5	AlMg2.5	(N4)	A-G2.5C/5052	A5052
	3.3537	AW-5454	AlMg2.7Mn	AlMg2.7Mn	N51/5454	A-G2.5MC/5454	A5454
	3.3525	AW-5251	AlMg2Mn0.3	AlMg2Mn0.3	N4 /5251	A-U2M	
	3.3527	AW-5049	AlMg2Mn0.8	AlMg2Mn0.8		A-G2Mn0.8	
	3.3535	AW-5754	AlMg3	AlMg3		A-G3M	
	3.3345			AlMg3			A5082
	3.3547	AW-5083	AlMg4.5Mn	AlMg4.5Mn	N8/5083	A-G4.5MC	
	3.3545	AW-5086	AlMg4Mn	AlMg4Mn	(N5/6)	A-G4MC-5086	
	3.3206	AW-6060	AlMgSi0.5	AlMgSi0.5	(H9)/(6060)	A-GS/6060	
	3.3210	AW-6063	AlMgSi0.7	AlMgSi0.7	(H10)	A-GSUC/6061	(A6063)
	3.2315	AW-6082	AlMgSi1	AlMgSi1	H30/6082	A-SGM0.7/6082	
	3.0615			AlMgSiPb		A-SGPb	
	3.0505	AW-3105	AlMn0.5Mg0.5	AlMn0.5Mg0.5	N31		
	3.0525	AW-3005	AlMn0.5Mg0.5	AlMn0.5Mg0.5		A-MG0.5/3005	-
	3.0515	AW-3103	AlMn1	AlMn1	N3/3103		
	3.0517	AW-3003	AlMn1Cu	AlMn1Cu		A-M1/3003	A3003
	3.0526	AW-3004	AlMn1Mg1	AlMn1Mg1		A-M1G/3004	-
	3.4335	AW-7020	AlZn4.5Mg1	AlZn4.5Mg1	H17/7020	A-Z5G/7020	
	3.4345			AlZnMgCu0.5		A-Z4GU	
	3.4365	AW-7075		AlZnMgCu1.5	2L95/96	A-Z5GU/7075	A7075
	3.1841	AC-21100	AlCu4Ti	G-AlCu4Ti			
	3.1371	AC-21000	AlCu4TiMg	G-AlCu4TiMg	2L91/92	A-U5GT	
	3.3541	AC-51100	AlMg3	G-AlMg3		A-G3T	
	3.3241			G-AlMg3Si			
	3.3261	AC-51400	AlMg5(Si)	G-AlMg5			
	3.3555	AC-51400	AlMg5	G-AlMg5	LM5		
	3.3292	AC-51200	AlMg9	G-AlMg9			
	3.2381	AC-43400	AlSi10Mg(Fe)	G-AlSi10Mg	LM9	A-S10G	
	3.2341	AC-42000		G-AlSi5Mg	LM25	A-S7G	
	3.2151	AC-45000	AlSi6Cu4	G-AlSi6Cu4			
	3.2371	AC-42100	AlSi7Mg	G-AlSi7Mg	2L99	A-S7GO3	
	3.2161	AC-46200	AlSi8Cu3(Si)	G-AlSi8Cu3			
	3.2373	AC-43200	AlSi9Mg	G-AlSi9Mg		A-S10G	
	3.5106			G-MgAg3Se2Zr1			
	3.5314	MG-P-62	MgAl3Zn	G-MgAl3Zn	MAG-E-111	G-A3-Z1	
	3.5662	MC 21230	MgAl6Mn	G-MgAl6Mn			
	3.5612	MG-P-63	MgAl6Zn	G-MgAl6Zn	MAG-E-121	G-A6-Z1	
	3.5812	MG-P-61	MgAl8Zn	G-MgAl8Zn	MAG1-M	G-A9	
	3.5812	MC 21110	MgAl8Zn1	G-MgAl8Zn1	A82	G-A92	
	3.5912	MC 21120	MgAl9Zn	G-MgAl9Zn1	MAG3	G-A92	
	3.5200			G-MgMn2	MAG-E-101	G-M2	
3.5103	MB 65110	MgSe3Zn2Zr1	G-MgSe3Zn2Zr1	MAG6-TE	ZRE1		
3.5105			G-MgTh3Zn2Zr1				
17	3.2383	AC-43200	AlSi10Mg(Cu)	G-AlSi10Mg(Cu)			
	3.2382	AC-44200	AlSi12	GD-AlSi12			
		AC-46100	AlSi11Cu2(Fe)		LM9		ADC12
		AC-47100	AlSi12Cu1(Fe) AlSi17Cu5				ADC14
18	2.1203	CW004A		Cu			
	2.0940.01	CW013A	CuAg0.1	CuAg0.1	Cu-Ag-4		
		CC331G		CuAl10Fe	AB1	CuAl10Fe	
	2.0975.01	CC333G-GZ CC333G		CuAl10Fe5Ni5 CuAl10Ni	AB2	CuAl10Ni5Fe5	

• Non-Ferrous metal

The material group of workpieces							
UNI	SS	AISI/ASTM	UNS	Condition	Misc. Brands	Structure	Form
4010			AA1200				
4007			AA1050A				
4005			AA1070A				
4004			AA1080A				
			AA2117				
4355			AA2011				
			AA2017A				
			AA2024				
4338			AA2014				
4106			AA5005A				
			AA5050B				
			AA6061				
4120			AA5052				
			AA5454				
			AA5251				
4115			AA5049				
4125			AA5754				
			AA5082				
4140			AA5083				
			AA5086				
4103			AA6060				
4104,4107			AA6005				
4212			AA6082				
			AA6012				
			AA3105				
			AA3005				
4054			AA3103				
			AA3003				
			AA3004				
4425			AA7020				
			AA7022				
			AA7075				
4337		204	A02040				
		5140	A05140				
		5056A					
4163							
4253		B85	A13600				
4244		B26					
4245			A13560				
4251		A380					
		359,2					
		4418					
4633			AZ31B				
			AM60A				
			AZ61A				
			AZ80A				
4637		4437	AZ81A				
4635			AZ91A/B				
		4442	M1A				
			B80				
			B80				
		A413.2					
		A384.0	AA384				
		B390.0					
5015			C11600				
5030			C95200				
5710		CA952					
5716		CA955	C95500				



• Non-Ferrous metal

mat. group		The material group of workpieces					
W.- Nr	EN	EN-Nr	DIN	BS	AFNOR	JIS	
18	2.0966	CW307G	CuAl10Ni5Fe4	CuAl10Ni5Fe4	Ca104	CuAl10Ni	C6301
	2.0978	CW308G	CuAl11Ni6Fe6	CuAl11Ni6Fe5			
	2.0916			CuAl5			
	2.0918	CW300G	CuAl5As	CuAl5As			
	2.0932			CuAl8 Fe3			C6140
	2.1291			CuCr			
	2.1310	CW107C	CuFe2P	CuFe2P			
	2.0853	CW109C	CuNi1Si	CuNi1.5Si			
	2.0872		CuNi10Fe1Mn	CuNi10Fe1Mn	CZ102	CuNi10Fe1Mn	
				CuNi10Zn45			
	2.0780	CW406J	CuNi12Zn30Pb1	CuNi12Zn30Pb1			
	2.0790		CW408J	CuNi18Zn19Pb1		CuNi18Zn19Pb1	
	2.0790	CW408J	CuNi18Zn19Pb1	CuNi18Zn19Pb1		CuNi18Zn19Pb1	
	2.0740	CW409J	CuNi18Zn20	CuNi18Zn20	Ns106	CuNi18Zn20	C7451
	2.0742	CW410J	CuNi18Zn27	CuNi18Zn27	NS107		
	2.0822			CuNi20			
	2.0830			CuNi25	CN105	CuNi25	
	2.0835			CuNi30			
	2.0883			CuNi30Fe2Mn2			
				CuNi30FeMn			
	2.0882	CW354H	CuNi30Mn1Fe	CuNi30Mn1Fe	CN107	CuNi30Mn1Fe	
	2.0857	CW112C	CuNi3Si	CuNi3Si			
	2.0842			CuNi44Mn1		CuNi44Mn	
				CuNi5Fe1Mn		CuNi5Fe1Mn	
	2.0875	CW351H	CuNi9Sn2	CuNi9Sn2			
	2.1176	CW352H		CuPb10Sn	LB2	CuSn10Pb10	
	2.1183	CC496K-GZ		CuPb15Sn			
	2.1160	CW113C	Cupb1p	CuPb1P			
	2.1189			CuPb20Sn			
	2.1050.01	CC480K		CuSn10	CT1	CuSn10	
	2.1087			CuSn10Zn			
	2.1051.01	CC483K		CuSn12	PB2	CuSn12	
				CuSn14		CuSn14	
	2.1016	CW450K	CuSn4	CuSn4	PB101	CuSn4p	C5111
			CW451K	CuSn5			
	2.1020	CW452K	CuSn6	CuSn6	PB103	CuSn6	C5191
	2.1080			CuSn6Zn6			
				CuSn7			
	2.1090.03	CC493K-GZ		CuSn7ZnPb			
	2.1030	CW453K	CuSn8	CuSn8	PB104	CuSn8P	C5210
	2.0230	CW501L	CuZn10	CuZn10	CZ101	CuZn10	C2200
	2.0240	CW502L	CuZn15	CuZn15	CZ102	CuZn15	C2300
	2.0250	CW503L	CuZn20	CuZn20	CZ103		C2400
	2.0460	CW702R	CuZn20Al2	CuZn20Al2	CZ110	CuZn22Al2	
				CuZn25Al5			
2.0261	CW504L	CuZn28	CuZn28	CZ105		C4430	
2.0470	CW706R	CuZn28Sn1	CuZn28Sn1		CuZn29Sn1		
2.0265	CW505L	CuZn30	CuZn30	CZ106	CuZn30	C2600	
			CuZn30AlFeMn		CuZn30AlFeMn		
2.0490	CW708R	CuZn31Si1	CuZn31Si1				
2.0280	CW506L	CuZn33	CuZn33	CZ107		C2680	
2.0592.01	CC765S		CuZn35Al1	HTB1	CuZn30AlFeMn		
2.0540	CW710R	CuZn35Ni2	CuZn35Ni2				
2.0335	CW507L	CuZn36	CuZn36	CZ108	CuZn36	C2720	
2.0331	CW601N	CuZn35Pb2	CuZn36Pb1.5	CZ131	CuZn35Pb2		
2.0375	CW602N	CuZn36Pb3	CuZn36Pb3	CZ124	CuZn36Pb3		
2.0321	CW508L	CuZn37	CuZn37	CZ108	CuZn37		
2.0332	CW604N	CuZn37Pb0.5	CuZn37Pb0.5	CZ118			
2.0371	CW607N	CuZn38Pb1.5	CuZn38Pb1.5	CZ119	(CuZn38Pb2)		
2.0530	CW717R	CuZn38Sn1	CuZn38Sn1				
2.0525	CW715R	CuZn38SnAl	CuZn38SnAl				
			CuZn39AlFeMn				
2.0372	CW610N	CuZn39Pb0.5	CuZn39Pb0.5	CZ123	CuZn39Pb0.8		
2.0380	CW612N	CuZn39Pb2	CuZn39Pb2	CZ128			
2.0401	CW614N	CuZn39Pb3	CuZn39Pb3	CZ121	CuZn39Pb3		
2.0360	CW509	CuZn40	CuZn40	CZ109	CuZn40	C2800	
2.0550	CW713R		CuZn40A12				

• Non-Ferrous metal

The material group of workpieces										
UNI	SS	AISI/ASTM	UNS	Condition	Misc. Brands	Structure	Form			
CuNi30	5667		C62730							
			C60800							
			C18400							
			C19400							
			C70600							
			C79300							
			C76300							
			C76300							
			C75200							
			C77000							
CuNi30	5682		C71300							
			C71580							
CuSn7	5640	CA937	C70600							
			C70250							
			C72150							
			C72500							
			C93700							
			C93800							
			C19000							
			C94100							
			C90700							
			C90500							
CuSn7	5443 5458 5465 5475	CA907	C91000							
			C51100							
			C51000							
			C51900							
			CuSn7	5428		C93200				
						C83600				
						C52100				
						C22000				
						C23000				
						C24000				
C68700										
C86300										
C25600										
C44300										
CuSn7	5220 5122		C26000							
			CuSn7	5256	CA865	C26800				
						C96500				
						C27200				
						C34200				
						C36000				
						C27200				
						C33500				
						C35300				
						C46400				
C47000										
CuSn7	5150 5165		C36500							
			C37700							
			C38500							
			C28000							
			C67410							
CuSn7	5170		C36500							
			C37700							
			C38500							
			C28000							
			C67410							



• Non-Ferrous metal

mat. group	The material group of workpieces						
	W.- Nr	EN	EN-Nr	DIN	BS	AFNOR	JIS
18	2.0572	CW723R	CuZn40Mn1	CuZn40Mn1			
	2.0580	CW720R	CuZn40Mn1Pb	CuZn40Mn1Pb	CZ136		
	2.0402	CW612N	CuZn40Pb2	CuZn40Pb2	CZ120	CuZn39Pb2	
	2.0410	CW622N	CuZn44Pb2	CuZn44Pb2	CZ104		
	2.0220	CW500L	CuZn5	CuZn5	CZ125		C2100

Heat resistant super alloys / Titanium alloys

19							
	X2NiCrAlTi3220		1.4876				
20							
21	NiMo30		2.4810				
	NiMo30		2.4810				
	NiMo16Cr15W		2.4602				
	NiMo16Cr16Ti		2.4819				
			2.4610				
			2.4619				
	NiCr21Fe18Mo9						
			2.4665				

• Non-Ferrous metal



The material group of workpieces							
UNI	SS	AISI/ASTM	UNS	Condition	Misc.Brands	Structure	Form
	5168 5272		C37800 C68700 C21000		AMPCO 15 AMPCO 18 AMPCO 18.136 AMPCO 18.22 AMPCO 18.23 AMPCO 21 AMPCO 22 AMPCO 25 AMPCO 26 AMPCO 45 AMPCO 483 AMPCO 642 AMPCO 673 AMPCO 674 AMPCO 8 AMPCO 863 AMPCO M4		
Heat resistant super alloys / Titanium alloys							
			S66286 S35000 S35000 S35500 S45500 N08800 N19909 R30155 R30155	Precip.hardened heat treated	A286 AM350 AM350 AM355 Custom 455 Discalloy Incoloy 800 Incoloy 801 Incoloy 909 Lapelloy M-308 N-155 N-155		cast bar, forge, ring
			R30195		Air Resist 13 FSX-414 H531 Haynes 188 Haynes 188 Haynes 25 Mar-M-302 Mar-M-509 MP159 MP35N Stellite 21 Stellite 30 Stellite 31 W152 W162		bar, forge, ring tube
			N10665 N10002 N10002 N10276 N06455 N06007 N06985 N10003 N10003 N06635 N10004 N06002		Astrolay GTD222 Hastelloy B-2 Hastelloy C Hastelloy C Hastelloy C-22 Hastelloy C-276 Hastelloy C-4 Hastelloy G Hastelloy G-3 Hastelloy N Hastelloy N Hastelloy S Hastelloy W Hastelloy X		all forms plate cast bar, sforge, ring cast all forms all forms



• Heat resistant super alloys / Titanium alloys

mat. group	The material group of workpieces						
	W.- Nr	EN	EN-Nr	DIN	BS	AFNOR	JIS
21	2.4816 2.4851 2.4856 2.4856 2.4856	NiCr15Fe NiCr22Mo9Nb NiCr22Mo9Nb NiCr22Mo9Nb NiFe38Cr16Nb					
	2.4668 2.4668 2.4668	NiCr19Fe19Nb5Mo3 NiCr19Fe19Nb5Mo3 NiCr19Fe19Nb5Mo3					
	2.4669 2.4669						
	2.4061	Ni99.6					
	2.4634 2.4636 2.4650 2.4631	NiCr20TiAl					
	2.4632 2.4662						
	ppm	NiCr19Co18Mo4Ti3Al3					
	2.4654 2.4654	NiCr20Co13Mo4Ti3Al NiCr20Co13Mo4Ti3Al					
	3.7024 3.7024			TiV10Fe2Al3			
	3.7124	TiCu2					
		TiAl5Sn2.5 TiAl5Sn2.5 TiAl5Sn2.5					
	3.7164 3.7164	TiAl6V4 TiAl6V4					
	3.7164 3.7164	TiAl6V4 TiAl6V4					

Dimensions And Torque Values Of Insert Screw

 Screw	 Th	Nm	ISO Size	 Key
C018035	M1.8(4h)	0.5	6IP	T06P
C025045	M2.5(4h)	1.2	8IP	T08P
C02506	M2.5(4h)	1.2	8IP	T08P
C03006	M3.0(4h)	2.0	9IP	T09P
C03007	M3.0(4h)	2.0	9IP	T09P
C03008	M3.0(4h)	2.0	9IP	T09P
C03010	M3.0(4h)	2.0	9IP	T09P
C03012	M3.0(4h)	2.0	9IP	T09P
C03505	M3.5(4h)	3.0	10IP	T10P
C03506	M3.5(4h)	3.0	10IP	T10P
C03507	M3.5(4h)	3.0	10IP	T10P
C03508-T15	M3.5(4h)	3.5	15IP	T15P
C03510	M3.5(4h)	3.0	10IP	T10P
C03511	M3.5(4h)	3.0	10IP	T10P
C03512	M3.5(4h)	3.0	10IP	T10P
C03513	M3.5(4h)	3.0	10IP	T10P
C04008	M4.0(4h)	4.0	15IP	T15P
C04011	M4.0(4h)	4.0	15IP	T15P
C04013	M4.0(4h)	4.0	15IP	T15P
C04014	M4.0(4h)	4.0	15IP	T15P
C04016	M4.0(4h)	4.0	15IP	T15P
C04017	M4.0(4h)	4.0	15IP	T15P
C04511	M4.5(4h)	5.0	20IP	T20P
C05013	M5.0(4h)	6.0	20IP	T20P

• Always apply solid lubricant paste prior to fasten screws.

Cutting Data Calculation

• Nomenclature and formulae

RPM

$$n = \frac{v_c \cdot 1000}{\pi \cdot D} \quad (\text{rev/min})$$

Cutting speed

$$v_c = \frac{n \cdot \pi \cdot D}{1000} \quad (\text{m/min})$$

Feed speed

$$v_f = n \cdot z \cdot f_z \quad (\text{mm/min})$$

$$v_f = n \cdot z_c \cdot f_z \quad (\text{mm/min})$$

Feed per revolution

$$f_n = z \cdot f_z \quad (\text{mm/rev})$$

Metal removal rate

$$Q = \frac{a_e \cdot a_p \cdot v_f}{1000} \quad (\text{cm}^3/\text{min})$$

Cutting speed and RPM for copying

$$v_c = \frac{n \cdot \pi \cdot D}{1000} \quad (\text{m/min})$$

$$n = \frac{v_c \cdot 1000}{\pi \cdot D} \quad (\text{RPM})$$

$$D = 2 \cdot \sqrt{a_p (D - a_p)} \quad (\text{RPM})$$

Feed speed in tapping

$$v_f = n \cdot \text{pitch} \quad (\text{mm/min})$$

a_e = Width of cut mm/radial depth of cut	(mm)
a_p = Depth of cut mm/axial depth of cut	(mm)
D = Cutter diameter	(mm)
f = Feed per revolution	(mm/rev)
f_z = Feed per tooth	(mm/tooth)
z_c = Effective no. of teeth for calculation of feed speed or feed per rev (see below)	
n = RPM	(rev/min)
Q = Material removal rate	(cm ³ /min)
v_c = Cutting speed	(m/min)
v_f = Feed speed	(mm/min)
z = No of teeth	

Effective no. of teeth (Z_c)

The effective no. of teeth (Z_c) is used to calculate the feed speed (v_f) and the feed per revolution (f). For most of cutters, effective no. of teeth (Z_c) is equal to the no. of teeth of the cutter (z), but for some of cutters Z_c is less than z , such as SC/SCL/ST/STL / CE/CWL/CEL cutter and spot drill.

Especially in spot drill, the Z_c need to be calculated with 1 flute in centering process and 2 flutes in chamfering process.



TECHNICAL GUIDE

Standard keyway and pin hole figures

FIG.1

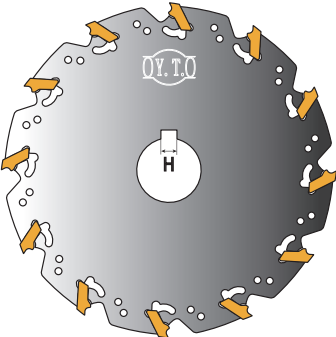

H

FIG.2

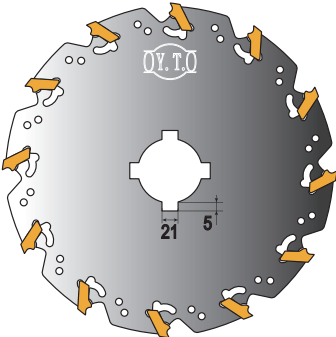

H

FIG.3

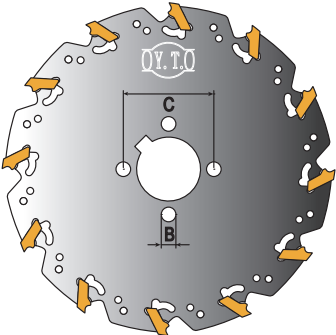

C B

Vibrations Solution

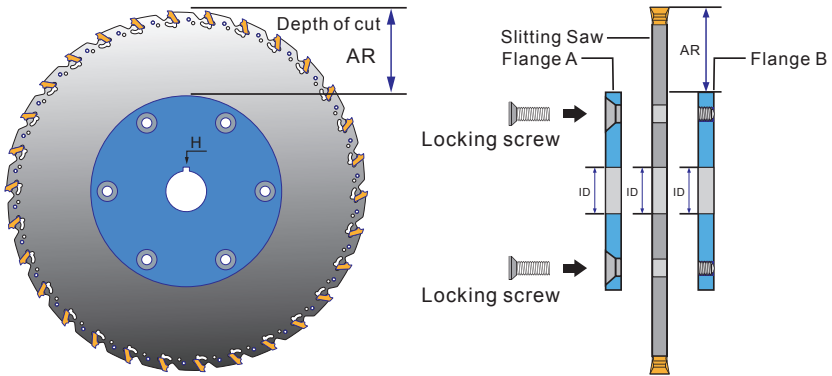

- Improve the stability of cutters and workpieces
- Minimize tool overhang
- Minimize the dia of cutter
- Increase the thickness of cutter, refer to above diagram



Trouble Shooting

The solution for vibrations and unstable machining

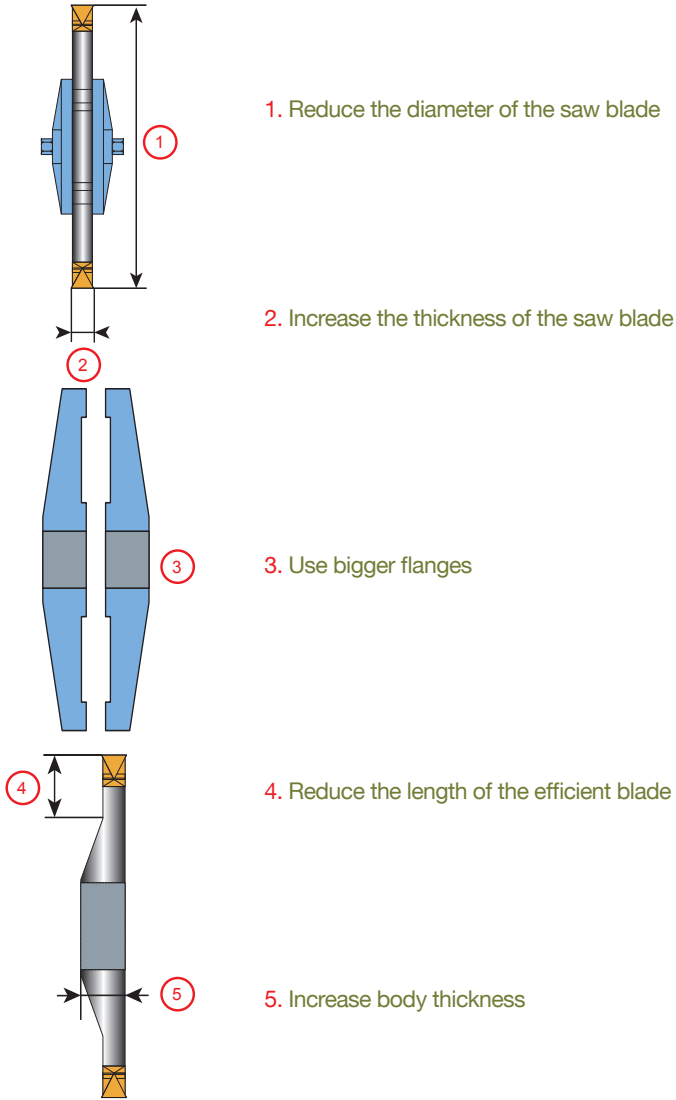

Attention :

1. Please follow the trouble shooting above in order to obtain better cutting surface finishes
2. Must conform to the speed factor

Trouble Shooting

Vibrations

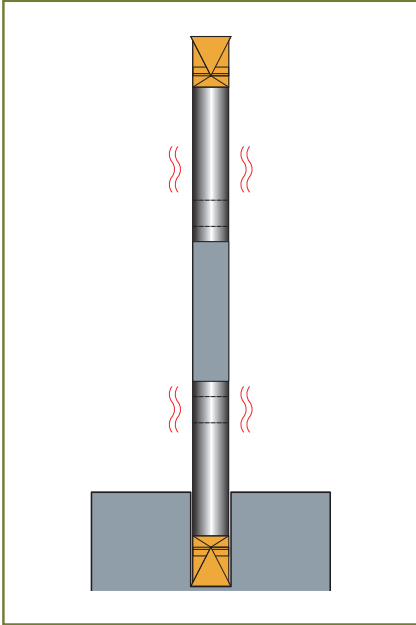

- Improve the stability of cutter and workpiece
- Change cutter positioning
- Minimize tool overhang
- Reduce the cutting speed
- Increase the feed rate
- Reduce the depth of cut

Poor Surface Finish

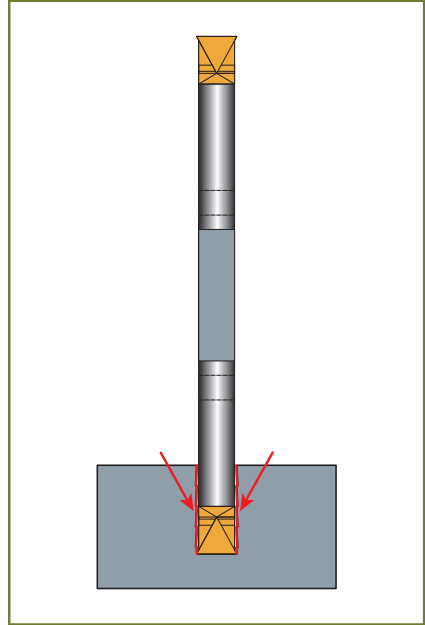

- Improve the stability of cutter and workpiece
- Minimize tool overhang
- Reduce the feed rate
- Increase the cutting speed
- Use a coolant
- Use wiper insert



Technical Guide

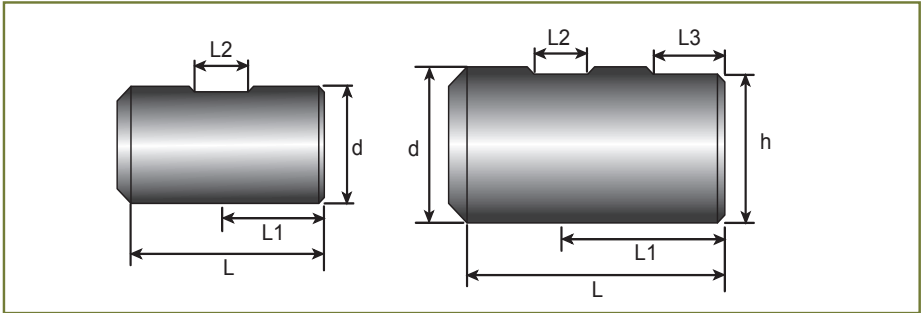

Dimensions Of Mounting Metric Size

Dimensions (mm)					
d	L	L1	L2	L3	h
6	36	18	4.2	-	-
8	36	18	5.5	-	-
10	40	20	7	-	-
12	45	22.5	8	-	-
16	48	24	10	-	14.2
20	50	25	11	-	18.2
25	56	32	12	17	23
32	60	36	14	19	30
40	70	40	14	19	38

Climb & Conventional Milling

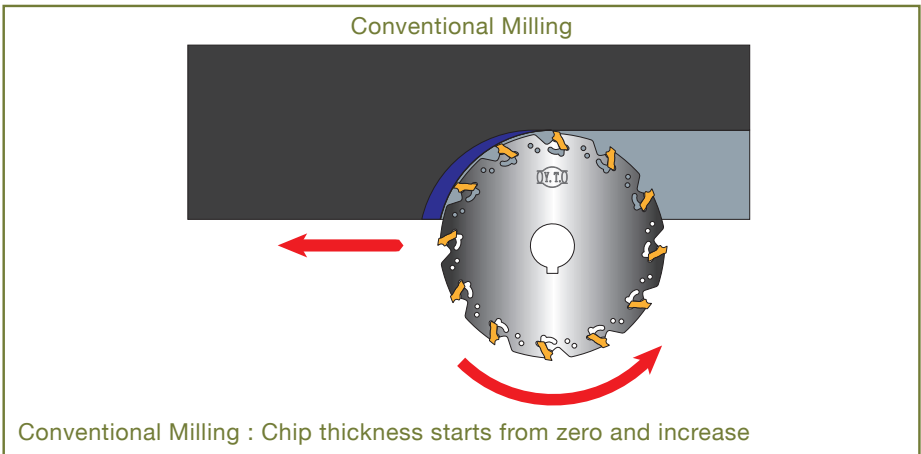
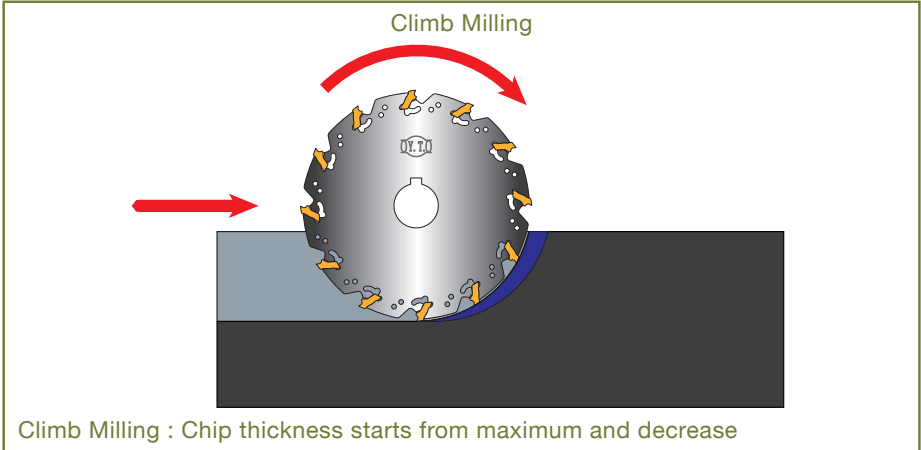

Cutting Data

Slot Milling

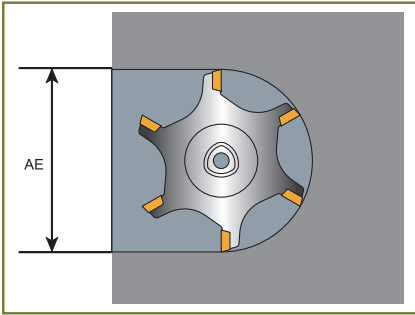

Side Milling

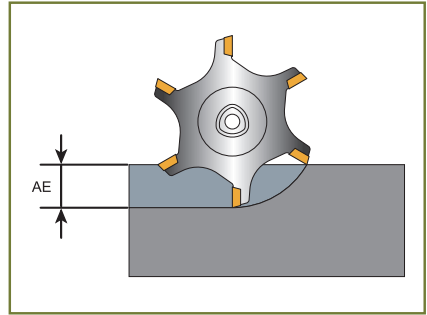

Relative Engagement Of The Cutter Diameter	Multiply The Feed Per Tooth By The Following Factor
30%	1.25
20%	1.5
10%	2.0
5%	3.0

This Table Can Be Used For Cutters With Cutting Edge Angle = 90°

AE / D %	Feed Per Tooth / mm (fz)														Speed factor
	0.03	0.06	0.08	0.10	0.15	0.20	0.25	0.30	0.40	0.50	0.60	0.80	1.00		
	Average Chip Thickness mm (hm)														
Width Of Cut Up To And Inching D / 2															
2 (0.02)	-	-	-	-	0.02	0.03	0.04	0.04	0.06	0.07	0.08	0.11	0.14	1.8	
3 (0.03)	-	-	-	0.02	0.03	0.03	0.04	0.05	0.07	0.09	0.10	0.14	0.17	1.7	
5 (0.05)	-	-	0.02	0.02	0.03	0.04	0.06	0.07	0.09	0.11	0.13	0.18	0.22	1.6	
10 (0.10)	-	0.02	0.02	0.03	0.05	0.06	0.08	0.09	0.12	0.16	0.19	0.25	0.31	1.5	
15 (0.15)	0.011	0.02	0.03	0.04	0.06	0.08	0.09	0.11	0.15	0.19	0.23	0.30	-	1.4	
20 (0.20)	0.013	0.03	0.03	0.04	0.06	0.09	0.11	0.13	0.17	0.22	0.26	-	-	1.35	
30 (0.30)	0.016	0.03	0.04	0.05	0.08	0.10	0.13	0.16	0.21	0.26	0.31	-	-	1.3	
40 (0.40)	0.018	0.04	0.05	0.06	0.09	0.12	0.15	0.18	0.23	0.29	-	-	-	1.25	
50 (0.50)	0.02	0.04	0.05	0.06	0.10	0.13	0.16	0.19	0.25	0.32	-	-	-	1.2	
Slot Milling (Width Of Cut = D)															
100 (1.0)	0.02	0.04	0.05	0.06	0.10	0.13	0.16	0.19	0.25	0.32	-	-	-	1.0	

Instead Of Using The Table Above For Calculating hm And fz The Following Formulae Could Be Used If (AE/D) < 30%

$$hm = fz \cdot \sqrt{\frac{AE}{D}}$$

$$fz = hm \cdot \sqrt{\frac{D}{AE}}$$

